



# PVC White Schedule 40 Fittings, Unions, & Saddles



## TECHNICAL INFORMATION WEIGHTS & DIMENSIONS



Visit our web site  
[www.spearsmfg.com](http://www.spearsmfg.com)



## Performance Engineered & Tested



SPEARS® Schedule 40 PVC fitting designs combine years of proven experience with computer generated stress analysis to yield the optimum physical structure and performance for each fitting. Material reinforcement is uniformly placed in stress concentration areas for substantially improved pressure handling capability. Resulting products are subjected to numerous verification tests to assure the very best PVC fittings available.

### Full 1/4" Through 12" Availability

Spears® comprehensive line of PVC fittings offers a variety of injection molded configurations in Schedule 40 sizes 1/4" through 12" conforming to ASTM D 2466.

### Exceptional Chemical & Corrosion Resistance

Unlike metal, PVC fittings never rust, scale, or pit, and will provide many years of maintenance-free service and extended system life.

### High Temperature Ratings

PVC thermoplastic can handle fluids at service temperatures up to 140°F (60°C), allowing a wide range of process applications, including corrosive fluids.

### Lower Installation Costs

Substantially lower material costs than steel alloys or lined steel, combined with lighter weight and ease of installation, can reduce installation costs by as much as 60% over conventional metal systems.

### Higher Flow Capacity

Smooth interior walls result in lower pressure loss and higher volume than conventional metal fittings.

### Additional Fabricated Configurations through 36"

Extra large, hard-to-find, and custom configurations are fabricated from NSF® Certified pipe. Fittings are engineered and tested to provide full pressure handling capabilities according to Spears® specifications.

### PVC Valves

SPEARS® PVC Valve products are available for total system compatibility and uniformity.

### Advanced Design Specialty Fittings

Spears® wide range of innovative, improved products include numerous metal-to-plastic transition fittings and unions with Spears® patented special reinforced (SR) plastic threads.

### 1/2" Through 16" Industrial Pipe Availability

Spears® premium quality Industrial CPVC pipe is offered in Schedule 40 White sizes 1/2" through 16".

### Sample Engineering Specifications

All PVC Schedule 40 fittings shall be produced by Spears® Manufacturing Company from PVC Type I cell classification 12454, conforming to ASTM D 1784. All injection molded PVC Schedule 40 fittings shall be Certified for potable water service by NSF International and manufactured in strict compliance to ASTM D 2466. All fabricated fittings shall be produced in accordance with Spears® General Specifications for Fabricated Fittings.



The information contained in this publication is based on current information and Product design at the time of publication and is subject to change without notification. Our ongoing commitment to product improvement may result in some variation. No representations, guarantees or warranties of any kind are made as to its accuracy, suitability for particular applications or results to be obtained therefrom. For verification of technical data or additional information not contained herein, please contact Spears® Technical Services Department [West Coast: (818) 364-1611 — East Coast: (678) 985-1263].

## General Information

### Recommendations For Installers And Users

Plastic piping systems should be **ENGINEERED, INSTALLED** and **OPERATED** in accordance with **ESTABLISHED DESIGN AND ENGINEERING STANDARDS AND PROCEDURES** for plastic piping systems. Suitability for the intended service application should be determined by the installer and/or user prior to installation of a plastic piping system. **PRIOR TO ASSEMBLY, all piping system components should be inspected for damage or irregularities. Mating components should be checked to assure that tolerances and engagements are compatible. Do not use any components that appear irregular or do not fit properly. Contact the appropriate manufacturer of the component product in question to determine usability. Consult all applicable codes and regulations for compliance prior to installation.**

**Solvent Weld Connections** — Use quality solvent cements and primers formulated for the intended service application, pipe size and type of joint. While the pipe and fitting materials may be compatible with the intended medium, the solvent cement may not be. Consult the manufacturers for suitability of use. Read and follow the cement and primer manufacturers' applications and cure time instructions thoroughly. Be sure to use the correct size applicator.

**Threaded Connections** — Use a quality grade thread sealant. **WARNING: SOME PIPE JOINT COMPOUNDS OR PTFE PASTES MAY CONTAIN SUBSTANCES THAT COULD CAUSE STRESS CRACKING TO PLASTIC.** Spears® Manufacturing Company recommends the use of Spears® **BLUE 75™** Thread Sealant which has been tested for compatibility with Spears® products. Please follow the sealant manufacturers' application / installation instructions. Choice of an appropriate thread sealant other than those listed above is at the discretion of the installer. 1 to 2 turns beyond **FINGER TIGHT** is generally all that is required to make a sound plastic threaded connection. Unnecessary **OVERTIGHTENING** will cause **DAMAGE TO BOTH PIPE AND FITTING.**

"Lead Free" low lead certification – unless otherwise specified, all Spears® Schedule 40 fittings specified here-in are certified by NSF International to ANSI/NSF® Standard 61, Annex G and is in compliance with California's Health & Safety Code Section 116825 (commonly known as AB1953) and Vermont Act 193. Weighted average lead content  $\leq 0.25\%$ .



# PVC WHITE SCHEDULE 40 FITTINGS UNIONS & SADDLES

## ASTM STANDARD DIMENSIONS

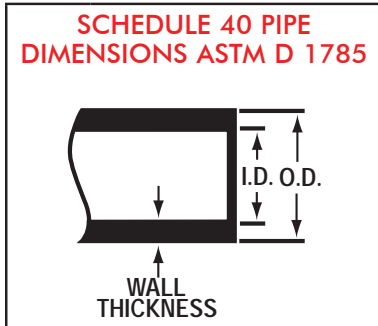

Nominal Pipe Size In.	Mean Outside Diameter In.	O. D. Tolerance In.	Minimum Wall Thickness In.
1/8	.405	± .004	.068
1/4	.540	± .004	.088
3/8	.675	± .004	.091
1/2	.840	± .004	.109
3/4	1.050	± .004	.113
1	1.315	± .005	.133
1-1/4	1.660	± .005	.140
1-1/2	1.900	± .006	.145
2	2.375	± .006	.154
2-1/2	2.875	± .007	.203
3	3.500	± .008	.216
4	4.500	± .009	.237
5	5.563	± .010	.258
6	6.625	± .011	.280
8	8.625	± .015	.322
10	10.750	± .015	.365
12	12.750	± .015	.408

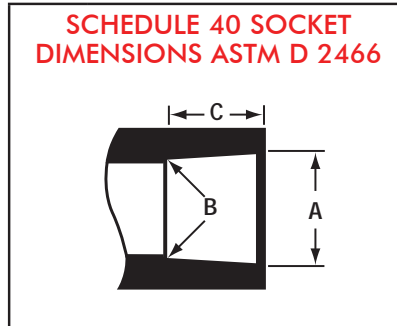

Nominal Size In.	Diameter			Socket Length Minimum C
	Entrance A	Bottom B	Tolerance A	
1/8	.417	.401	± .004	.500
1/4	.552	.536	± .004	.500
3/8	.687	.671	± .004	.594
1/2	.848	.836	± .004	.688
3/4	1.058	1.046	± .004	.719
1	1.325	1.310	± .005	.875
1-1/4	1.670	1.655	± .005	.938
1-1/2	1.912	1.894	± .006	1.094
2	2.387	2.369	± .006	1.156
2-1/2	2.889	2.868	± .007	1.750
3	3.516	3.492	± .008	1.875
4	4.518	4.491	± .009	2.000
5	5.583	5.553	± .010	3.000
6	6.647	6.614	± .011	3.000
8	8.655	8.610	± .015	4.000
10	10.780	10.735	± .015	5.000
12	12.780	12.735	± .015	6.000



Nominal Size In.	Threads Per Inch.	Effective Thread Length L	Pitch Of Thread P
1/8	27	.2639	.03704
1/4	18	.4018	.05556
3/8	18	.4078	.05556
1/2	14	.5337	.07143
3/4	14	.5457	.07143
1	11-1/2	.6828	.08696
1-1/4	11-1/2	.7068	.08696
1-1/2	11-1/2	.7235	.08696
2	11-1/2	.7565	.08696
2-1/2	8	1.1375	.12500
3	8	1.2000	.12500
4	8	1.3000	.12500
5	8	1.4063	.12500
6	8	1.5125	.12500
8	8	1.7125	.12500

Molded Schedule 40 products are manufactured to ASTM D 2466 for use with pipe manufactured to ASTM D 1785. Certain products carry reduced pressure handling capability and have maximum internal pressure ratings at 73°F noted.

Fabricated Schedule 40 pressure fittings (part numbers ending with "F") are manufactured to Spears® specifications for use with pipe manufactured to ASTM D 1785. See publication FAB-7, General Specifications for Standard Fabricated Fittings for additional information.

All specified Schedule 40 products are manufactured from materials certified by NSF® for use in potable water service.

# PVC WHITE SCHEDULE 40 FITTINGS UNIONS & SADDLES



## Injection Molded Dimension References:

- G** = (LAYING LENGTH) intersection of center lines to bottom of socket/thread; 90° elbows, tees, crosses; ± 1/32 inch.
- H** = Intersection of center lines to face of fitting; 90° elbows, tees, crosses; ± 1/32 inch.
- J** = Intersection of center lines to bottom of socket/thread; 45° elbows; ± 1/32 inch

- L** = Overall length of fittings; ± 1/16 inch.
- M** = Outside diameter of socket/thread hub; ± 1/16 inch.
- N** = Socket bottom to socket bottom; couplings; ± 1/16 inch.
- W** = Height of cap; ± 1/16 inch.

## Fabricated Dimension References:

- G** = (LAYING LENGTH) intersection of center lines to bottom of socket/thread; 90° elbows, tees, crosses; ± 1/4 inch; 14" & larger ± 1/2 inch.
- H** = Intersection of center lines to face of fitting; 90° elbows, tees, crosses; ± 1/4 inch.; wyes ± 1/2 inch; 14" & larger ± 1/2 inch.
- J** = Intersection of center lines to bottom of socket/thread; 45° elbows; ± 1/4 inch; 14" & larger ± 1/2 inch.

- L** = Overall length of fittings; ± 1/2 inch.; wyes ± 1 inch; 14" & larger ± 1 inch.
- M** = Outside diameter of socket/thread hub; ± 1/4 inch.
- N** = Socket bottom to socket bottom; couplings; ± 1/2 inch.
- W** = Height of cap; ± 1/4 inch.

## Typical Fabricated Dimension References

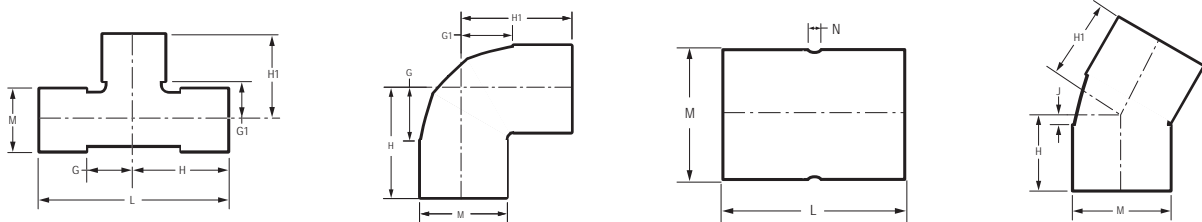

## TEE

Socket x Socket x Socket

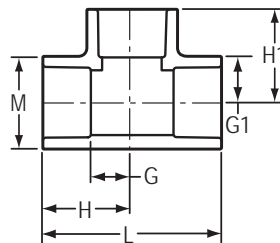

Part Number	Size	G	G1	H	H1	L	M	Approx. Wt. (Lbs.)
401-003	3/8	3/8	3/8	1-1/8	1-1/8	2-1/4	31/32	.04
401-005	1/2	1/2	1/2	1-1/4	1-1/4	2-1/2	1-3/32	.06
401-007	3/4	9/16	9/16	1-9/16	1-9/16	3-1/8	1-5/16	.10
401-010	1	11/16	11/16	1-3/4	1-3/4	3-1/2	1-5/8	.16
401-012	1-1/4	7/8	7/8	2-1/8	2-1/8	4-1/4	2	.25
401-015	1-1/2	1-3/32	1-3/32	2-11/32	2-11/32	4-11/16	2-1/4	.36
401-020	2	1-3/8	1-3/8	2-3/4	2-3/4	5-1/2	2-3/4	.51
401-025	2-1/2	1-21/32	1-21/32	3-13/32	3-13/32	6-13/16	3-11/32	1.03



# PVC WHITE SCHEDULE 40 FITTINGS UNIONS & SADDLES

## TEE (continued)

Socket x Socket x Socket

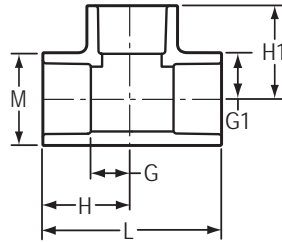

Part Number	Size	G	G1	H	H1	L	M	Approx. Wt. (Lbs.)
401-030	3	1-15/16	1-15/16	3-27/32	3-27/32	7-11/16	4	1.43
401-040	4	2-13/32	2-13/32	4-7/16	4-7/16	8-7/8	5-1/32	2.22
401-050	5	3	3	6	6	12	6-5/32	4.59
401-060	6	3-5/8	3-5/8	6-21/32	6-21/32	13-5/16	7-9/32	6.00
401-080	8	4-1/2	4-1/2	8-17/32	8-17/32	17-1/16	9-3/8	11.81
401-100	10	5-13/16	5-13/16	10-27/32	10-27/32	21-11/16	11-21/32	24.25
401-100F	10	9-7/8	9-3/8	15-1/8	14-5/8	30-1/4	11-1/2	36.21
401-120	12	6-27/32	6-27/32	12-27/32	12-27/32	25-11/16	13-3/4	37.94
401-120F	12	10-3/4	10-3/16	17	16-7/16	34	13-9/16	56.32
401-140F	14	11-3/8	11	18-3/8	18	36-3/4	14-7/8	75.11
401-160F	16	15	12-7/8	23	20-7/8	46	17	111.00
401-180F	18	15-7/8	13-3/8	24-7/8	22-3/8	49-3/4	19-1/8	151.26
401-200F	20	18-1/4	15-1/2	28-1/4	25-1/2	56-1/2	21-3/16	206.74
401-240F	24	21-1/8	17-1/2	33-1/8	29-1/2	66-1/4	25-3/8	337.03

## REDUCING TEE

Socket x Socket x Socket

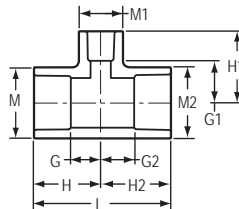

Part Number	Size	G	G1	G2	H	H1	H2	L	M	M1	M2	Approx. Wt. (Lbs.)
401-053	3/8x3/8x1/2	17/32	21/32	17/32	2-1/32	1-3/4	2-1/32	4-1/16	7/8	1-3/32	7/8	.08
401-074	1/2x1/2x3/4	9/16	9/16	9/16	1-5/16	1-9/16	1-5/16	2-5/8	1-1/16	1-9/32	1-1/16	.07
401-075	1/2x1/2x1	25/32	17/32	25/32	1-17/32	1-11/16	1-17/32	3-1/16	1-1/16	1-5/8	1-1/16	.11
401-094	3/4x1/2x1/2	17/32	21/32	17/32	1-17/32	1-13/32	1-7/32	2-13/16	1-5/16	1-3/32	1-3/32	.08
401-095	3/4x1/2x3/4	13/16	11/16	5/8	1-13/16	1-15/32	1-3/8	3-3/16	1-5/16	1-5/16	1-1/16	.10
401-101	3/4x3/4x1/2	17/32	5/8	17/32	1-7/16	1-3/8	1-7/16	2-29/32	1-5/16	1-1/8	1-5/16	.08
D401-101	3/4x3/4x1/2	9/16	19/32	17/32	1-17/32	1-27/32	1-17/32	3-1/16	1-5/16	1-3/32	1-5/16	.11
401-102	3/4x3/4x1	23/32	5/8	23/32	1-21/32	1-21/32	1-21/32	3-5/16	1-5/16	1-5/8	1-5/16	.11
401-122	1x1/2x1	23/32	23/32	27/32	1-25/32	1-25/32	1-19/32	3-7/16	1-5/8	1-5/8	1-3/32	.14

# PVC WHITE SCHEDULE 40 FITTINGS UNIONS & SADDLES



## REDUCING TEE (continued)

Socket x Socket x Socket

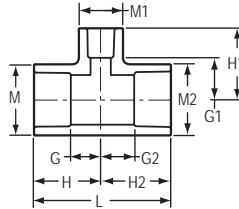

Part Number	Size	G	G1	G2	H	H1	H2	L	M	M1	M2	Approx. Wt. (Lbs.)
401-124	1x3/4x1/2	5/8	23/32	19/32	1-21/32	1-15/32	1-1/2	3-5/32	1-5/8	1-3/32	1-5/16	.12
401-125	1x3/4x3/4	21/32	25/32	5/8	1-25/32	1-25/32	1-5/8	3-7/16	1-19/32	1-5/16	1-5/16	.14
401-126	1x3/4x1	3/4	13/16	13/16	1-29/32	1-15/16	1-13/16	3-3/4	1-5/8	1-5/8	1-5/16	.17
401-130	1x1x1/2	9/16	13/16	9/16	1-5/8	1-9/16	1-5/8	3-3/16	1-5/8	1-1/16	1-5/8	.13
D401-130	1x1x1/2	11/16	25/32	11/16	1-23/32	2-1/32	1-23/32	3-15/32	1-5/8	1-1/8	1-5/8	.15
401-131	1x1x3/4	19/32	3/4	19/32	1-5/8	1-21/32	1-5/8	3-9/32	1-5/8	1-5/16	1-5/8	.14
401-132	1x1x1-1/4	31/32	27/32	31/32	2-3/32	2-3/32	2-3/32	4-3/16	1-5/8	1-31/32	1-5/8	.22
401-133	1x1x1-1/2	1-1/8	13/16	1-1/8	2-1/4	2-1/8	2-1/4	4-1/2	1-5/8	2-9/32	1-5/8	.24
401-134	1x1x2	1-7/16	27/32	1-7/16	2-1/2	2-1/4	2-1/2	5	1-5/8	2-3/4	1-5/8	.31
401-156	1-1/4x1x1/2	21/32	1	17/32	1-25/32	1-3/4	1-21/32	3-7/16	2	1-1/16	1-5/8	.18
401-157	1-1/4x1x3/4	5/8	1	21/32	1-29/32	2	1-25/32	3-11/16	1-31/32	1-5/16	1-5/8	.20
401-158	1-1/4x1x1	13/16	1	7/8	2-1/16	2-3/32	2	4	1-31/32	1-21/32	1-5/8	.22
401-166	1-1/4x1-1/4x1/2	17/32	29/32	17/32	1-25/32	1-21/32	1-25/32	3-9/16	1-31/32	1-3/32	1-31/32	.18
D401-166	1-1/4x1-1/4x1/2	23/32	31/32	23/32	1-31/32	2-3/16	1-31/32	3-29/32	2	1-1/8	2	.22
401-167	1-1/4x1-1/4x3/4	21/32	31/32	21/32	1-29/32	1-31/32	1-29/32	3-13/16	2	1-11/32	2	.22
401-168	1-1/4x1-1/4x1	13/16	31/32	13/16	1-15/16	2-1/32	1-15/16	3-27/32	2	1-5/8	2	.22
401-169	1-1/4x1-1/4x1-1/2	1-3/32	1	1-3/32	2-11/32	2-5/16	2-11/32	4-11/16	1-31/32	2-7/32	1-31/32	.30
401-170	1-1/4x1-1/4x2	1-11/32	1	1-11/32	2-19/32	2-3/8	2-19/32	5-3/16	2	2-3/4	2	.38
401-199	1-1/2x1-1/4x1/2	17/32	1-1/8	17/32	1-27/32	1-7/8	1-25/32	3-5/8	2-7/32	1-1/16	1-31/32	.22
401-201	1-1/2x1-1/4x3/4	21/32	1-5/32	21/32	1-15/16	2-3/16	1-15/16	3-7/8	2-1/4	1-11/32	2	.26
401-202	1-1/2x1-1/4x1	13/16	1-3/16	13/16	2-1/8	2-9/32	2-1/16	4-3/16	2-1/4	1-5/8	2	.30
401-209	1-1/2x1-1/2x1/2	17/32	1-1/32	17/32	1-27/32	1-25/32	1-27/32	3-11/16	2-3/16	1-1/16	2-3/16	.21
D401-209	1-1/2x1-1/2x1/2	17/32	1-1/16	17/32	1-27/32	2-5/16	1-27/32	3-11/16	2-7/32	1-1/16	2-7/32	.23
401-210	1-1/2x1-1/2x3/4	21/32	1-3/32	21/32	1-31/32	2-3/32	1-31/32	3-29/32	2-7/32	1-5/16	2-7/32	.24
401-211	1-1/2x1-1/2x1	25/32	27/32	25/32	2-3/32	1-31/32	2-3/32	4-3/16	2-7/32	1-5/8	2-7/32	.28
401-212	1-1/2x1-1/2x1-1/4	1	1-3/16	1	2-9/32	2-7/16	2-9/32	4-19/32	2-1/4	2	2-1/4	.31
401-213	1-1/2x1-1/2x2	1-5/16	1-3/16	1-5/16	2-5/8	2-9/16	2-5/8	5-7/32	2-1/4	2-3/4	2-1/4	.39
401-214	1-1/2x1-1/2x2-1/2	1-21/32	1-3/16	1-21/32	2-31/32	2-15/16	2-31/32	5-15/16	2-1/4	3-11/32	2-1/4	.58
401-233	2x1x2	1-1/4	1-1/4	1-7/32	2-19/32	2-19/32	2-11/32	5	2-3/4	2-3/4	1-5/8	.40
401-238	2x1-1/2x3/4	21/32	1-13/32	21/32	2-1/32	2-13/32	1-31/32	4	2-23/32	1-5/16	2-1/4	.31
401-239	2x1-1/2x1	13/16	1-1/2	13/16	2-1/8	2-5/8	2-1/8	4-9/32	2-3/4	1-5/8	2-1/4	.38
401-241	2x1-1/2x1-1/2	1	1-9/32	1-1/32	2-3/8	2-9/16	2-5/16	4-11/16	2-23/32	2-7/32	2-7/32	.37
401-247	2x2x1/2	17/32	1-11/32	17/32	1-29/32	2-3/32	1-29/32	3-27/32	2-23/32	1-3/32	2-23/32	.30
D401-247	2x2x1/2	9/16	1-7/32	9/16	1-15/16	2-1/2	1-15/16	3-7/8	2-23/32	1-1/16	2-23/32	.31



# PVC WHITE SCHEDULE 40 FITTINGS UNIONS & SADDLES

## REDUCING TEE Socket x Socket x Socket

(continued)

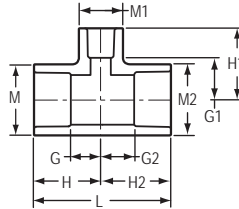

Part Number	Size	G	G1	G2	H	H1	H2	L	M	M1	M2	Approx. Wt. (Lbs.)
401-248	2x2x3/4	21/32	1-1/2	21/32	2-1/32	2-1/16	2-1/32	4-1/16	2-3/4	1-11/32	2-3/4	.32
401-249	2x2x1	13/16	1-3/8	13/16	2-3/16	2-1/2	2-3/16	4-3/8	2-23/32	1-5/8	2-23/32	.36
401-250	2x2x1-1/4	1	1-3/8	1	2-3/8	2-5/8	2-3/8	4-23/32	2-23/32	1-31/32	2-23/32	.39
401-251	2x2x1-1/2	1-1/16	1-5/16	1-1/16	2-3/8	2-9/16	2-3/8	4-3/4	2-23/32	2-1/4	2-23/32	.42
401-253 <sup>1</sup>	2x2x3	2-7/8	1-13/16	2-7/8	4-1/4	3-13/16	4-1/4	8-1/2	4	4	3-15/16	2.64
401-254 <sup>1</sup>	2x2x4	3-13/32	2-3/8	3-13/32	4-25/32	4-3/8	4-25/32	9-9/16	5-1/16	5-1/16	5-1/16	3.89
401-287	2-1/2x2-1/2x1/2	25/32	1-15/32	25/32	2-17/32	2-7/32	2-17/32	5-1/16	3-5/16	1-1/16	3-5/16	.56
401-288	2-1/2x2-1/2x3/4	7/8	1-9/16	7/8	2-5/8	2-1/2	2-5/8	5-9/32	3-5/16	1-5/16	3-5/16	.60
401-289	2-1/2x2-1/2x1	13/16	1-17/32	13/16	2-13/16	2-21/32	2-13/16	5-5/8	3-5/16	1-5/8	3-5/16	.67
401-290	2-1/2x2-1/2x1-1/4	1-7/32	1-21/32	1-7/32	2-31/32	2-29/32	2-31/32	5-31/32	3-11/32	2-1/32	3-11/32	.77
401-291	2-1/2x2-1/2x1-1/2	1-3/16	1-5/8	1-3/16	2-31/32	2-15/16	2-31/32	5-15/16	3-11/32	2-1/4	3-11/32	.76
401-292	2-1/2x2-1/2x2	1-13/32	1-21/32	1-13/32	3-3/16	3-1/32	3-3/16	6-3/8	3-5/16	2-3/4	3-5/16	.78
401-293 <sup>1</sup>	2-1/2x2-1/2x3	2-1/4	1-31/32	2-1/4	4-1/4	3-13/16	4-1/4	8-15/32	4	4	4	2.37
401-294 <sup>1</sup>	2-1/2x2-1/2x4	2-3/4	2-3/8	2-3/4	4-3/4	4-3/8	4-3/4	9-1/2	5-1/16	5	5-1/16	4.03
401-333	3x3x1/2	11/16	1-13/16	11/16	2-9/16	2-17/32	2-9/16	5-1/32	3-31/32	1-3/32	3-31/32	.76
401-334	3x3x3/4	3/4	2	3/4	2-21/32	3	2-21/32	5-9/32	4	1-11/32	4	.84
401-335	3x3x1	29/32	1-25/32	29/32	2-51/64	2-29/32	2-51/64	5-19/32	3-31/32	1-19/32	3-31/32	.85
401-336	3x3x1-1/4	1-7/32	1-31/32	1-7/32	2-31/32	3-7/32	2-31/32	5-15/16	4	2	4	.92
401-337	3x3x1-1/2	1-7/32	1-13/16	1-7/32	3-3/32	3-1/8	3-3/32	6-3/16	4-1/16	2-7/32	4-1/16	1.00
401-338	3x3x2-1/2	1-7/16	1-13/16	1-7/16	3-11/32	3-3/16	3-11/32	6-11/16	3-31/32	2-23/32	3-31/32	1.05
401-342	3x3x4	2-1/2	2-1/16	2-1/2	4-1/2	4-1/16	4-1/2	9	3-31/32	5	3-31/32	1.87
401-344 <sup>1</sup>	3x3x6	5-1/2	4	5-1/2	7-1/2	7	7-1/2	15	7-1/4	7-1/4	7-1/4	11.75
401-416	4x4x3/4	25/32	2-9/32	25/32	2-13/16	3-9/32	2-13/16	5-5/8	5-3/32	1-5/16	5-3/32	1.24
401-417	4x4x1	13/16	2-9/16	13/16	2-13/16	3-5/8	2-13/16	5-19/32	5-1/32	1-19/32	5-1/32	1.19
401-418	4x4x1-1/4	1-1/16	2-9/32	1-1/16	3-3/32	3-17/32	3-3/32	6-3/16	5	1-31/32	5	1.33
401-419	4x4x1-1/2	1-3/16	2-17/32	1-3/16	3-3/16	3-27/32	3-3/16	6-13/32	5-1/16	2-1/4	5-1/16	1.40
401-420	4x4x2	1-13/32	2-3/4	1-13/32	3-7/16	4-5/32	3-7/16	6-7/8	5-1/32	2-3/4	5-1/32	1.49
401-421 <sup>1</sup>	4x4x2-1/2	1-31/32	3-3/32	2-1/32	4-3/32	4-27/32	4-3/32	8-5/32	5-5/32	4-1/16	5-5/32	2.67
401-422	4x4x3	2-1/32	2-5/8	2-1/32	4-3/32	4-1/2	4-3/32	8-5/32	5-5/32	4-1/16	5-5/32	2.31
401-426 <sup>1</sup>	4x4x6	5-1/2	3-1/2	5-1/2	7-1/2	7	7-1/2	14-15/16	6-7/8	7-1/2	6-7/8	10.38
401-428 <sup>1</sup>	4x4x8	6-3/4	4-1/2	6-3/4	8-3/4	8-1/2	8-3/4	17-1/2	9-1/4	9-5/8	9-5/8	18.30
401-486	5x5x2	1-11/32	3-1/32	1-11/32	4-23/64	4-13/32	4-23/64	8-23/32	6-1/8	2-23/32	6-1/8	2.39
401-487 <sup>1</sup>	5x5x2-1/2	2	3-5/8	2	5-1/32	5-3/8	5-1/32	10-1/16	6-5/32	4-1/32	6-5/32	3.63
401-488	5x5x3	2	3-3/16	2	5-1/32	5-1/16	5-1/32	10-1/16	6-5/32	4-1/32	6-5/32	3.23
401-490	5x5x4	2-1/2	3-5/32	2-1/2	5-9/16	5-3/16	5-9/16	11-1/8	6-5/32	5-1/32	6-5/32	3.61
401-526 <sup>1</sup>	6x6x1-1/4	1-3/8	4-1/16	1-3/8	4-27/32	5-5/16	4-27/32	9-11/16	7-1/4	2-3/4	7-1/4	3.61

<sup>1</sup> Outlet sized with bushing



# PVC WHITE SCHEDULE 40 FITTINGS UNIONS & SADDLES



## REDUCING TEE (continued)

Socket x Socket x Socket

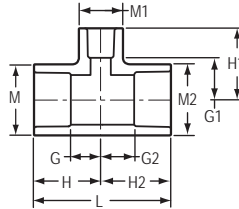

Part Number	Size	G	G1	G2	H	H1	H2	L	M	M1	M2	Approx. Wt. (Lbs.)
401-527 <sup>1</sup>	6x6x1-1/2	1-3/8	3-7/8	1-3/8	4-27/32	5-3/16	4-27/32	9-11/16	7-1/4	2-11/16	7-1/4	3.60
401-528	6x6x2	1-13/32	3-5/8	1-13/32	4-13/32	4-31/32	4-13/32	8-27/32	7-1/4	2-3/4	7-1/4	3.28
401-529	6x6x2-1/2	2	3-15/16	2	5-1/2	5-15/16	5-1/2	10-15/16	7-3/16	3-15/16	7-3/16	4.29
401-530	6x6x3	1-31/32	3-5/8	1-31/32	4-31/32	5-1/2	4-31/32	10	7-1/4	4	7-1/4	3.90
401-532	6x6x4	2-3/32	3-5/8	2-3/32	5-9/16	5-5/8	5-9/16	11-1/8	7-7/32	5	7-7/32	4.35
401-533 <sup>1</sup>	6x6x5	3-1/2	4-1/2	3-1/2	7	7-1/2	7	14	7-3/16	7-3/16	7-3/8	8.46
401-535 <sup>1</sup>	6x6x8	5-3/8	5-1/2	5-3/8	8-7/8	9-1/2	8-7/8	17-3/4	9-1/2	9-3/4	9-1/2	19.21
401-537 <sup>1</sup>	6x6x10	8	5-13/16	8	11-3/8	10-13/16	11-3/8	22-3/4	11-1/2	11-9/16	11-1/2	38.30
401-578 <sup>1</sup>	8x8x2	2	5-7/8	2	6	7	6	12	9-1/4	4	9-1/4	11.71
401-579 <sup>1</sup>	8x8x2-1/2	2	5-5/16	2	6	7-5/16	6	12	9-5/16	4	9-5/16	6.62
401-580	8x8x3	1-31/32	4-3/4	1-31/32	6-1/32	6-3/4	6-1/32	12-1/16	9-11/32	4	9-11/32	6.44
401-582	8x8x4	2-17/32	4-11/16	2-17/32	6-17/32	6-11/16	6-17/32	13-1/16	9-9/32	4-31/32	9-9/32	7.02
401-583 <sup>1</sup>	8x8x5	3-21/32	5-1/4	3-21/32	7-21/32	8-1/4	7-21/32	15-5/16	9-5/16	7-1/4	9-5/16	10.60
401-585	8x8x6	3-5/8	4-3/4	3-5/8	7-21/32	7-25/32	7-21/32	15-11/32	9-11/32	7-1/4	9-11/32	8.90
401-589 <sup>1</sup>	8x8x10	6-23/32	5-11/16	6-23/32	11-7/32	10-1/2	11-7/32	22-7/16	11-9/16	11-9/16	11-9/16	34.76
401-621F	10x10x2	4-7/8	7-1/4	4-7/8	10-1/8	9	10-1/8	20-1/4	11-1/2	2-11/16	11-1/2	19.60
401-622F	10x10x2-1/2	5-5/8	7-3/4	5-5/8	10-7/8	9-3/4	10-7/8	21-3/4	11-1/2	3-1/4	11-1/2	20.26
401-623 <sup>1</sup>	10x10x3	3-13/16	7	3-13/16	9-3/8	9	9-3/8	18-3/4	12	7-1/2	12	25.54
401-624 <sup>1</sup>	10x10x4	3-27/32	7-3/8	3-27/32	9-11/32	9-3/8	9-11/32	18-11/16	12	7-1/2	12	25.63
401-626F	10x10x6	6-7/8	8-3/8	6-7/8	12-1/8	11-5/8	12-1/8	24-1/4	11-1/2	7-3/16	11-1/2	26.48
401-628 <sup>1</sup>	10x10x8	5-3/4	7-3/16	5-3/4	10-7/8	11-1/4	10-7/8	21-11/16	11-11/16	11-11/16	11-1/2	29.85
401-661F	12x12x2	5-1/4	8-1/4	5-1/4	11-1/2	10	11-1/2	23	13-9/16	2-11/16	13-1/2	25.00
401-662F	12x12x2-1/2	5-3/4	8-3/4	5-3/4	12	10-3/4	12	24	13-9/16	3-1/4	13-9/16	28.61
401-663F	12x12x3	5-3/4	9	5-3/4	12	11-1/4	12	24	13-9/16	3-15/16	13-9/16	31.41
401-664F	12x12x4	7	9-5/16	7	13-1/4	11-9/16	13-1/4	26-1/2	13-9/16	5	13-9/16	32.40
401-666 <sup>1</sup>	12x12x6	4-7/8	8-5/16	4-7/8	11-7/16	11-3/4	11-7/16	22-13/16	14-1/4	9-3/4	14-1/4	44.02
401-668	12x12x8	4-27/32	7-1/8	4-27/32	11-13/32	11-1/8	11-13/32	22-13/16	14-1/4	9-3/4	14-1/4	40.00
401-670	12x12x10	6-13/16	7-3/8	6-13/16	12-13/16	13-1/4	12-13/16	25-5/8	13-3/4	13-3/4	13-3/4	50.00
401-670F	12x12x10	10-1/4	10-3/8	10-1/4	16-1/2	15-5/8	16-1/2	33	13-9/16	11-1/2	13-9/16	50.00
401-676F	12x12x16	18-1/2	12-3/4	18-1/2	30-1/4	20-3/4	30-1/4	60-1/2	14-1/8	17	14-1/8	144.87
401-678F	12x12x18	14-1/4	13	17-7/8	23-1/4	22	23-7/8	47-3/4	19-1/8	19-1/8	19-1/8	252.00
401-691F	14x14x2	5-7/8	8-13/16	5-7/8	12-7/8	10-9/16	12-7/8	25-3/4	14-7/8	2-11/16	14-7/8	35.53
401-693F	14x14x3	6-1/2	9-9/16	6-1/2	13-1/2	11-13/16	13-1/2	27	14-7/8	3-15/16	14-7/8	38.35
401-694F	14x14x4	7-3/8	9-7/8	7-3/8	14-3/8	12-1/8	14-3/8	28-3/4	14-7/8	5	14-7/8	38.58
401-696F	14x14x6	7-7/8	9-15/16	7-7/8	14-7/8	13-3/16	14-7/8	29-3/4	14-7/8	7-3/16	14-7/8	45.70
401-698F	14x14x8	8-7/8	9-7/8	8-7/8	15-7/8	14-1/8	15-7/8	31-3/4	14-7/8	9-1/4	14-7/8	51.99

<sup>1</sup> Outlet sized with bushing



# PVC WHITE SCHEDULE 40 FITTINGS UNIONS & SADDLES

## REDUCING TEE (continued)

Socket x Socket x Socket

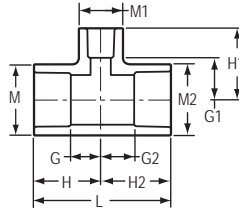

Part Number	Size	G	G1	G2	H	H1	H2	L	M	M1	M2	Approx. Wt. (Lbs.)
401-700F	14x14x10	10-3/8	10-15/16	10-3/8	17-3/8	16-3/16	17-3/8	34-3/4	14-7/8	11-1/2	14-7/8	61.56
401-702F	14x14x12	11-3/8	10-3/4	11-3/8	18-3/8	17	18-3/8	36-3/4	14-7/8	13-9/16	14-7/8	62.78
401-751F	16x16x2	6-3/8	9-3/4	6-3/8	14-3/8	11-1/2	14-3/8	28-3/4	17	2-11/16	17	51.76
401-753F	16x16x3	6-1/2	10-1/2	6-1/2	14-1/2	12-3/4	14-1/2	29	17	3-15/16	17	57.67
401-754F	16x16x4	8	10-13/16	8	16	13-1/16	16	32	17	5	17	58.90
401-756F	16x16x6	9	10-7/8	9	17	14-1/8	17	34	17	7-3/16	17	66.52
401-758F	16x16x8	10	10-13/16	10	18	15-1/16	18	36	17	9-1/4	17	73.17
401-760F	16x16x10	11	11-7/8	11	19	17-1/8	19	38	17	11-1/2	17	73.88
401-762F	16x16x12	12	11-11/16	12	20	17-15/16	20	40	17	13-9/16	17	85.48
401-764F	16x16x14	13	11-15/16	13	21	18-15/16	21	42	17	14-7/8	17	95.95
401-781F	18x18x2	6-1/4	10-11/16	6-1/4	15-1/4	12-7/16	15-1/4	30-1/2	19-1/8	2-11/16	19-1/8	65.63
401-783F	18x18x3	7-1/4	11-7/16	7-1/4	16-1/4	13-11/16	16-1/4	32-1/2	19-1/8	3-15/16	19-1/8	---
401-784F	18x18x4	7-3/4	11-3/4	7-3/4	16-3/4	14	16-3/4	33-1/2	19-1/8	5	19-1/8	82.00
401-786F	18x18x6	8-3/4	11-13/16	8-3/4	17-3/4	15-1/16	17-3/4	35-1/2	19-1/8	7-3/16	19-1/8	88.04
401-788F	18x18x8	9-3/4	11-3/4	9-3/4	18-3/4	16	18-3/4	37-1/2	19-1/8	9-1/4	19-1/8	107.00
401-790F	18x18x10	10-3/4	12-13/16	10-3/4	19-3/4	18-1/16	19-3/4	39-1/2	19-1/8	11-1/2	19-1/8	105.41
401-792F	18x18x12	11-3/4	12-5/8	11-3/4	20-3/4	18-7/8	20-3/4	41-1/2	19-1/8	13-9/16	19-1/8	113.48
401-794F	18x18x14	12-7/8	12-7/8	12-7/8	21-7/8	19-7/8	21-7/8	43-3/4	19-1/8	14-7/8	19-1/8	116.67
401-796F	18x18x16	13-7/8	13-13/16	13-7/8	22-7/8	21-13/16	22-7/8	45-3/4	19-1/8	17	19-1/8	134.41
401-811F	20x20x2	6-3/4	12-7/16	6-3/4	16-3/4	14-3/16	16-3/4	33-1/2	21-3/16	21-11/16	21-3/16	81.39
401-813F	20x20x3	7-1/4	12-7/16	7-1/4	17-1/4	14-11/16	17-1/4	34-1/2	21-3/16	3-15/16	21-3/16	91.14
401-814F	20x20x4	8-1/4	12-3/4	8-1/4	18-1/4	15	18-1/4	36-1/2	21-3/16	5	21-3/16	72.10
401-816F	20x20x6	9-1/4	12-13/16	9-1/4	19-1/4	16-1/16	19-1/4	38-1/2	21-3/16	7-3/16	21-3/16	106.19
401-818F	20x20x8	10-1/4	12-3/4	10-1/4	20-1/4	17	20-1/4	40-1/2	21-3/16	9-1/4	21-3/16	115.35
401-820F	20x20x10	11-1/4	13-13/16	11-1/4	21-1/4	19-1/16	21-1/4	42-1/2	21-3/16	11-1/2	21-3/16	125.44
401-822F	20x20x12	12-1/4	13-5/8	12-1/4	22-1/4	19-7/8	22-1/4	44-1/2	21-3/16	13-9/16	21-3/16	129.36
401-824F	20x20x14	13-1/4	13-7/8	13-1/4	23-1/4	20-7/8	23-1/4	46-1/2	21-3/16	14-7/8	21-3/16	123.55
401-826F	20x20x16	14-1/4	14-13/16	14-1/4	24-1/4	22-13/16	24-1/4	48-1/2	21-3/16	17	21-3/16	154.48
401-828F	20x20x18	15-1/4	14-3/8	15-1/4	25-1/4	23-3/8	25-1/4	50-1/2	21-3/16	19-1/8	21-3/16	176.98
401-901F	24x24x2	8-1/8	14-5/16	8-1/8	20-1/8	16-1/16	20-1/8	40-1/4	25-3/8	2-11/16	25-3/8	156.00
401-903F	24x24x3	8-5/8	14-5/16	8-5/8	20-5/8	16-9/16	20-5/8	41-1/4	25-3/8	3-15/16	25-3/8	161.00
401-904F	24x24x4	9-1/8	14-5/8	9-1/8	21-1/8	16-7/8	21-1/8	42-1/4	25-3/8	5	25-3/8	148.46
401-906F	24x24x6	10-1/8	14-11/16	10-1/8	22-1/8	17-15/16	22-1/8	44-1/4	25-3/8	7-3/16	25-3/8	159.56
401-908F	24x24x8	11-1/8	14-5/8	11-1/8	23-1/8	18-7/8	23-1/8	46-1/4	25-3/8	9-1/4	25-3/8	171.52
401-910F	24x24x10	12-1/8	15-11/16	12-1/8	24-1/8	20-15/16	24-1/8	48-1/4	25-3/8	11-1/2	25-3/8	213.94
401-912F	24x24x12	13-1/8	15-1/2	13-1/8	25-1/8	21-3/4	25-1/8	50-1/4	25-3/8	13-9/16	25-3/8	199.98

# PVC WHITE SCHEDULE 40 FITTINGS UNIONS & SADDLES



## REDUCING TEE (continued)

Socket x Socket x Socket

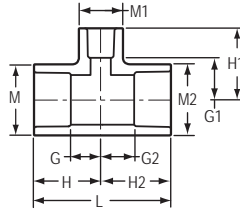

Part Number	Size	G	G1	G2	H	H1	H2	L	M	M1	M2	Approx. Wt. (Lbs.)
401-914F	24x24x14	13-3/4	15-3/4	13-3/4	25-3/4	22-3/4	25-3/4	51-1/2	25-3/8	14-7/8	25-3/8	232.53
401-916F	24x24x16	14-3/4	16-11/16	14-3/4	26-3/4	24-11/16	26-3/4	53-1/2	25-3/8	17	25-3/8	224.32
401-918F	24x24x18	15-3/4	16-1/4	15-3/4	27-3/4	25-1/4	27-3/4	55-1/2	25-3/8	19-1/8	25-3/8	237.92
401-920F	24x24x20	16-3/4	17-3/8	16-3/4	28-3/4	27-3/8	28-3/4	57-1/2	25-3/8	21-3/16	25-3/8	244.92

## REDUCING SHORT SOCKET TEE

Socket x Socket x Socket

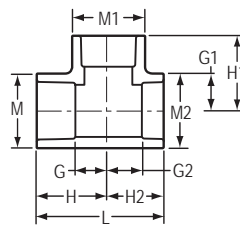

Part Number	Size	G	G1	G2	H	H1	H2	L	M	M1	M2	Approx. Wt. (Lbs.)
S401-249	2x2x1	11/16	2-7/32	11/16	2-3/32	1-1/4	1-11/32	3-7/16	2-23/32	1-5/8	2-23/32	.28
S401-251	2x2x1-1/2	1	1-1/4	31/32	2-3/8	2-3/8	1-5/8	4	2-23/32	2-7/32	2-23/32	.34

## TRANSITION TEE

Socket x Socket x Insert

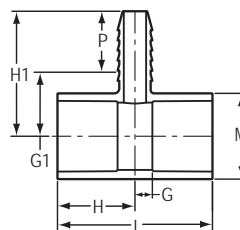

Part Number	Size	G	G1	H	H1	L	M	P	Approx. Wt. (Lbs.)
1102-007	3/4	13/32	3/4	1-13/32	2-1/4	2-13/16	1-5/16	1-1/2	.09
1102-130	1x1x1/2	3/16	13/16	1-7/16	2-5/16	2-7/8	1-19/32	1-1/2	.11
1102-248	2x2x3/4	1/2	1-7/16	1-27/32	2-15/16	3-11/16	2-23/32	1-1/2	.27
1102-250	2x2x1-1/4	11/16	1-15/32	2-1/16	2-31/32	4-1/8	2-3/4	1-1/2	.34



# PVC WHITE SCHEDULE 40 FITTINGS UNIONS & SADDLES

## STREET TEE

Spigot x Socket x Socket

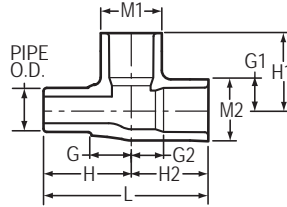

Part Number	Size	G	G1	G2	H	H1	H2	L	M1	M2	Approx. Wt. (Lbs.)
444-005	1/2	23/32	23/32	1/2	1-19/32	1-21/32	1-19/32	3-5/32	1-3/16	1-3/16	.10
444-007	3/4	13/16	27/32	7/8	1-13/16	1-7/8	1-13/16	3-5/8	1-13/32	1-13/32	.15
444-010	1	1	1-31/32	1-31/32	2-1/8	2	2-1/8	4-7/32	1-3/4	1-3/4	.25
444-012	1-1/4	1-1/4	1-5/32	1-1/8	2-7/16	2-5/16	2-7/16	4-27/32	2-3/32	2-3/32	.39
444-015	1-1/2	1-13/16	1-1/8	1-1/8	2-7/8	2-9/16	2-9/16	5-3/8	2-11/32	2-11/32	.51
444-020	2	1-19/32	1-11/16	1-19/32	3-3/32	3-3/16	3-3/32	6-5/32	2-7/8	2-7/8	.78

## TEE

Socket x Socket x Fipt

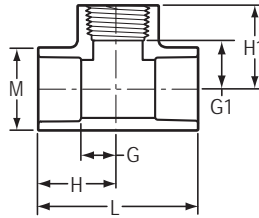

Part Number	Size	G	G1	H	H1	L	M	Approx. Wt. (Lbs.)
402-003	3/8	7/16	1/2	1-11/16	1-1/16	3-3/8	29/32	.06
402-005	1/2	1/2	1/2	1-1/4	1-7/32	2-1/2	1-3/32	.07
402-007	3/4	21/32	23/32	1-21/32	1-7/16	3-9/32	1-5/16	.11
402-010	1	13/16	7/8	1-15/16	1-7/8	3-7/8	1-5/8	.17
402-012	1-1/4	29/32	1-1/8	2-5/32	2-1/16	4-5/16	2	.30
402-015	1-1/2	1-1/32	1-1/32	2-11/32	2-1/16	4-21/32	2-1/4	.36
402-020	2	1-5/16	1-15/32	2-5/8	2-13/32	5-7/32	2-3/4	.50
402-025	2-1/2	1-1/2	1-11/16	3-1/4	2-31/32	6-1/2	3-3/8	.96
402-030	3	1-13/16	2-1/32	3-11/16	3-3/8	7-11/32	4	1.38
402-040	4	2-5/16	2-15/32	4-11/32	3-15/16	8-21/32	5-1/16	2.22

# PVC WHITE SCHEDULE 40 FITTINGS UNIONS & SADDLES



## REDUCING TEE

Socket x Socket x Fipt

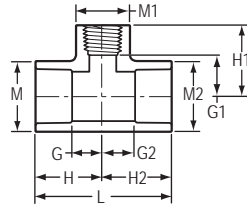

Part Number	Size	G	G1	G2	H	H1	H2	L	M	M1	M2	Approx. Wt. (Lbs.)
402-071	1/2x1/2x1/8	9/32	17/32	9/32	1-1/32	1	1-1/32	2-1/16	1-3/32	9/16	1-3/32	.04
402-072	1/2x1/2x1/4	3/8	9/16	3/8	1-1/8	1-1/8	1-1/8	2-1/4	1-1/16	13/16	1-1/16	.05
402-074	1/2x1/2x3/4	21/32	1/2	21/32	1-13/32	1-5/16	1-13/32	2-13/16	1-1/16	1-11/32	1-3/32	.08
402-094	3/4x1/2x1/2	1/2	11/16	9/16	1-1/2	1-7/16	1-5/16	2-13/16	1-9/32	1-1/16	1-3/32	.10
402-095	3/4x1/2x3/4	13/16	21/32	5/8	1-13/16	1-7/16	1-3/8	3-3/16	1-5/16	1-5/16	1-3/32	.11
402-101	3/4x3/4x1/2	17/32	3/4	17/32	1-17/32	1-7/16	1-17/32	3-1/16	1-5/16	1-3/32	1-5/16	.09
402-124	1x3/4x1/2	17/32	13/16	17/32	1-21/32	1-9/16	1-17/32	3-3/16	1-5/8	1-1/16	1-5/16	.13
402-125	1x3/4x3/4	9/16	23/32	11/16	1-11/16	1-17/32	1-11/16	3-3/8	1-19/32	1-9/32	1-9/32	.13
402-130	1x1x1/2	15/32	27/32	15/32	1-5/8	1-17/32	1-5/8	3-1/4	1-5/8	1-3/32	1-5/8	.13
402-131	1x1x3/4	21/32	13/16	21/32	1-25/32	1-17/32	1-25/32	3-9/16	1-5/8	1-5/16	1-5/8	.15
402-156	1-1/4x1x1/2	19/32	1-9/32	19/32	1-25/32	1-25/32	1-3/4	3-17/32	2	1-1/8	1-5/8	.19
402-157	1-1/4x1x3/4	13/16	1-1/32	3/4	1-13/16	1-23/32	1-3/4	3-9/16	2	1-5/16	1-5/8	.18
402-158	1-1/4x1x1	13/16	1-5/32	13/16	2-1/16	2-1/8	1-15/16	4	1-31/32	1-21/32	1-5/8	.26
402-166	1-1/4x1-1/4x1/2	23/32	15/16	23/32	1-31/32	1-21/32	1-31/32	3-15/16	1-31/32	1-3/32	1-31/32	.21
402-167	1-1/4x1-1/4x3/4	13/16	1-1/16	13/16	2-1/16	1-3/4	2-1/16	4-1/8	2	1-5/16	2	.19
402-168	1-1/4x1-1/4x1	21/32	1-1/32	21/32	1-7/8	1-27/32	1-7/8	3-25/32	1-31/32	1-5/8	1-31/32	.22
402-199	1-1/2x1-1/4x1/2	19/32	1-9/32	19/32	1-27/32	1-29/32	27/32	3-23/32	2-1/4	1-1/8	2	.24
402-201	1-1/2x1-1/4x3/4	11/16	1-5/32	5/8	1-31/32	2-5/32	1-29/32	3-7/8	2-1/4	1-5/16	2	.26
402-202	1-1/2x1-1/4x1	13/16	1-1/8	3/4	2-1/8	2-1/4	2-1/16	4-3/16	2-1/4	1-5/8	2	.30
402-209	1-1/2x1-1/2x1/2	7/16	1-3/16	7-16	1-3/4	1-7/8	1-3/4	3-1/2	2-7/32	1-3/32	2-7/32	.20
402-210	1-1/2x1-1/2x3/4	21/32	1-3/32	21/32	1-31/32	1-27/32	1-31/32	3-29/32	2-1/4	1-5/16	2-1/4	.24
402-211	1-1/2x1-1/2x1	25/32	1-1/16	25/32	2-3/32	1-15/16	2-3/32	4-3/16	2-1/4	1-5/8	2-1/4	.27
402-212	1-1/2x1-1/2x1-1/4	1	1-3/32	1	2-9/32	2-1/32	2-9/32	4-19/32	2-1/4	2	2-1/4	.32
402-238	2x1-1/2x3/4	11/16	1-13/32	5/8	2-1/32	2-13/32	1-31/32	4	2-3/4	1-5/16	2-1/4	.32
402-239	2x1-1/2x1	13/16	1-13/32	3/4	2-3/16	2-17/32	2-1/8	4-5/16	2-3/4	1-5/8	2-1/4	.38
402-247	2x2x1/2	21/32	1-3/8	21/32	2-1/32	2-1/8	2-1/32	4-1/16	2-3/4	1-1/16	2-3/4	.33
402-248	2x2x3/4	21/32	1-11/32	21/32	2-1/32	2-3/32	2-1/32	4-1/32	2-3/4	1-11/32	2-3/4	.33
402-249	2x2x1	13/16	1-13/32	13/16	2-3/16	2-1/4	2-3/16	4-3/8	2-23/32	1-5/8	2-23/32	.35
402-250	2x2x1-1/4	1	1-3/8	1	2-3/8	2-5/16	2-3/8	4-3/4	2-23/32	1-31/32	2-23/32	.40
402-251	2x2x1-1/2	1-1/16	1-1/4	1-1/16	2-5/16	2-3/16	2-5/16	4-19/32	2-3/4	2-1/4	2-3/4	.41
402-287	2-1/2x2-1/2x1/2	1/2	1-11/16	1/2	2-1/4	2-3/8	2-1/4	4-1/2	3-3/8	1-3/16	3-3/8	.55
402-288	2-1/2x2-1/2x3/4	13/16	1-11/16	13/16	2-9/16	2-7/16	2-9/16	5-1/8	3-3/8	1-3/8	3-3/8	.64
402-289	2-1/2x2-1/2x1	1	1-23/32	1	2-3/4	2-5/8	2-3/4	5-1/2	3-11/32	1-11/16	3-11/32	.73
402-290	2-1/2x2-1/2x1-1/4	1-1/32	1-25/32	1-1/32	2-25/32	2-21/32	2-25/32	5-9/16	3-11/32	2-1/32	3-11/32	.75
402-291	2-1/2x2-1/2x1-1/2	1-1/16	1-25/32	1-1/16	2-13/16	2-3/4	2-13/16	5-5/8	3-3/8	2-13/32	3-3/8	.77
402-292	2-1/2x2-1/2x2	1-1/2	1-27/32	1-1/2	3-1/4	2-27/32	3-1/4	6-17/32	3-11/32	3	3-11/32	.98
402-333	3x3x1/2	19/32	2-1/16	19/32	2-15/32	2-25/32	2-15/32	4-15/16	3-31/32	1-3/16	3-31/32	.77



# PVC WHITE SCHEDULE 40 FITTINGS UNIONS & SADDLES

## REDUCING TEE (continued)

Socket x Socket x Fipt

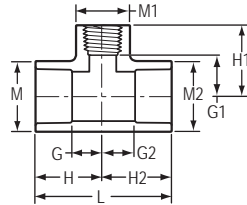

Part Number	Size	G	G1	G2	H	H1	H2	L	M	M1	M2	Approx. Wt. (Lbs.)
402-334	3x3x3/4	13/16	2-1/32	13/16	2-23/32	2-25/32	2-23/32	5-13/32	4	1-3/8	4	.83
402-335	3x3x1	31/32	2-1/32	31/32	2-7/8	2-15/16	2-7/8	5-23/32	4-1/32	1-11/16	4-1/32	.92
402-336	3x3x1-1/4	1	2-1/32	1	2-31/32	3-1/32	2-31/32	5-31/32	4	2	4	.95
402-337	3x3x1-1/2	1-7/32	2-1/8	1-7/32	3-3/32	3-1/16	3-3/32	6-3/16	4	2-13/32	4	1.05
402-338	3x3x2	1-1/2	2-1/8	1-1/2	3-3/8	3-1/8	3-3/8	6-25/32	4	3	4	1.22
402-417	4x4x1	27/32	2-5/8	27/32	2-7/8	3-1/2	2-7/8	5-3/4	5-1/32	1-11/16	5-1/32	1.26
402-419	4x4x1-1/2	1-1/8	2-1/2	1-1/8	3-1/8	3-1/2	3-1/8	6-1/4	5	2-1/4	5	1.33
402-420	4x4x2	1-3/8	2-3/4	1-3/8	3-13/32	3-3/4	3-13/32	6-25/32	5-1/32	3	5-1/32	1.67
402-422	4x4x3	2	2-1/2	2	4-1/32	3-29/32	4-1/32	8-1/16	5-1/16	4-9/32	5-1/16	2.18
402-490	5x5x4	2-1/2	3-1/8	2-1/2	5-17/32	4-29/32	5-17/32	11-1/16	6-3/32	5-1/32	6-3/32	3.69
402-525 <sup>1</sup>	6x6x1	1-3/8	4-11/32	1-3/8	4-27/32	5-11/32	4-27/32	9-11/16	7-7/32	2-23/32	7-7/32	3.66
402-528	6x6x2	1-3/8	3-19/32	1-3/8	4-27/32	4-23/32	4-27/32	9-23/32	7-1/4	2-25/32	7-1/4	3.58
402-530	6x6x3	2	3-19/32	2	5-15/32	5-7/32	5-15/32	10-15/16	7-1/4	4-1/32	7-1/4	4.22
402-532	6x6x4	2-1/2	3-5/8	2-1/2	6	5-11/32	6	12	7-7/32	5-1/16	7-7/32	4.73
402-578 <sup>1</sup>	8x8x2	2	6-1/8	2	6	7-1/8	6	12	9-5/16	3-15/16	9-5/16	6.81
402-580 <sup>1</sup>	8x8x3	2-9/16	5-23/32	1-31/32	6-9/16	7-5/16	6-9/16	13-1/8	9-5/16	5	9-5/16	7.69
402-582 <sup>1</sup>	8x8x4	2-1/2	4-15/16	2-1/2	6-31/32	6-21/32	6-31/32	13-15/16	9-5/16	5	9-5/16	11.20
402-621F	10x10x2	5-1/4	6-11/16	5-1/4	10-1/2	7-3/4	10-1/2	21	11-9/16	2-13/16	11-9/16	17.51
402-622F	10x10x2-1/2	5-1/2	8-1/2	5-1/2	10-3/4	10-1/4	10-3/4	21-1/2	11-9/16	3-5/16	11-9/16	14.80
402-624F	10x10x4	6-3/8	7	6-3/8	11-5/8	8-3/4	11-5/8	23-1/4	11-1/2	5-1/16	11-1/2	22.95
402-661F	12x12x2	5-3/4	7-13/16	5-3/4	12	8-7/8	12	24	13-5/8	2-13/16	13-5/8	26.92
402-663F	12x12x3	6-1/4	9	6-1/4	12-1/2	10-5/8	12-1/2	25	13-5/8	4	13-5/8	29.30
402-664F	12x12x4	6-7/8	8-1/4	6-7/8	13-1/8	10	13-1/8	26-1/4	13-9/16	5-1/16	13-9/16	31.48

<sup>1</sup>Outlet sized with bushing

## TEE

Socket x Socket x Mipt

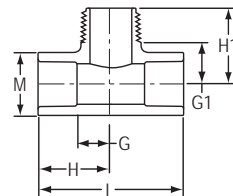

Part Number	Size	G	G1	H	H1	L	M	Approx. Wt. (Lbs.)
402B-010	1	5/8	1-1/16	1-3/4	2	3-7/16	1-5/8	.15

# PVC WHITE SCHEDULE 40 FITTINGS UNIONS & SADDLES



## SPECIAL REINFORCED TEE

Socket x Socket x SR Fipt

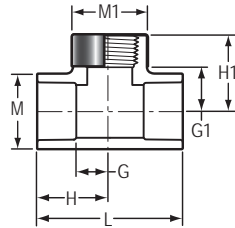

Part Number	Size	G	G1	H	H1	L	M	M1	Approx Wt. (Lbs.)
402-005SR	1/2	19/32	15/32	1-15/32	1-11/32	2-15/16	1-5/32	13/16	.13
402-012SR	1-1/4	29/32	1-1/8	2-5/32	2-1/16	4-5/16	1-31/32	2-1/16	.31

## SPECIAL REINFORCED REDUCING TEE

Socket x Socket x SR Fipt

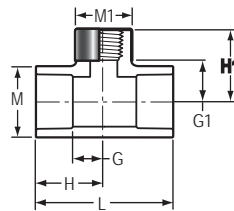

Part Number	Size	G	G1	H	H1	L	M	M1	Approx Wt. (Lbs.)
402-072SR	1/2x1/2x1/4	15/32	11/16	1-5/16	1-7/32	2-5/8	1-5/32	13/16	.09
402-098SR	3/4x3/4x1/4	7/16	13/16	1-7/16	1-11/32	2-7/8	1-3/8	13/16	.12
402-101SR	3/4x3/4x1/2	25/32	1/2	1-5/8	1-7/16	3-1/4	1-3/8	1-3/16	.15
402-166SR	1-1/4x1-1/4x1/2	7/16	1-1/8	1-11/16	1-7/8	3-3/8	2-3/32	1-3/16	.27
402-168SR	1-1/4x1-1/4x1	27/32	1-1/32	2-3/32	1-29/32	4-7/32	2-3/32	1-23/32	.35
402-212SR	1-1/2x1-1/2x1-1/4	1-1/32	1-5/32	2-7/16	2-3/32	4-27/32	2-3/8	2-1/16	.49
402-287SR	2-1/2x2-1/2x1/2	1/2	1-11/16	2-1/4	2-3/8	4-1/4	3-3/8	1-3/16	.55
402-288SR	2-1/2x2-1/2x3/4	13/16	1-23/32	2-9/16	2-7/16	5-1/8	3-3/8	1-3/8	.66
402-289SR	2-1/2x2-1/2x1	1	1-23/32	2-3/4	2-5/8	5-1/2	3-11/32	1-11/16	.75
402-290SR	2-1/2x2-1/2x1-1/4	1-1/32	1-25/32	2-25/32	2-21/32	5-9/16	3-11/32	2-1/32	.77
402-291SR	2-1/2x2-1/2x1-1/2	1-1/16	1-25/32	2-13/16	2-3/4	5-5/8	3-3/8	2-7/16	.80
402-292SR	2-1/2x2-1/2x2	1-1/2	1-27/32	3-1/4	2-27/32	6-17/32	3-11/32	3	1.02
402-333SR	3x3x1/2	19/32	2-1/16	2-15/32	2-25/32	4-15/16	3-31/32	1-3/16	.78
402-334SR	3x3x3/4	13/16	2-1/32	2-23/32	2-25/32	5-13/32	4	1-3/8	.84
402-335SR	3x3x1	31/32	2	2-7/8	2-29/32	5-23/32	4-1/32	1-23/32	.94
402-336SR	3x3x1-1/4	1-1/32	2-3/32	2-29/32	3-3/32	5-13/16	4	2-1/16	1.00
402-337SR	3x3x1-1/2	1-7/32	2-1/8	3-3/32	3-3/32	6-9/32	3-31/32	2-7/16	1.06
402-338SR	3x3x2	1-1/2	2-1/16	3-13/32	3-1/16	6-7/8	4	3	1.20
402-417SR	4x4x1	27/32	2-5/8	27/32	3-17/32	5-3/4	5-1/32	1-23/32	1.28
402-419SR	4x4x1-1/2	1-1/8	2-25/32	3-1/8	3-3/4	6-9/32	5-1/32	2-7/16	1.52
402-420SR	4x4x2	1-3/8	2-25/32	3-13/32	3-25/32	6-25/32	5-1/32	3-1/32	1.71
402-422SR	4x4x3	2	2-1/2	4-1/32	3-15/16	8-1/16	5-1/16	4-9/32	2.19



# PVC WHITE SCHEDULE 40 FITTINGS UNIONS & SADDLES

## REDUCING TEE

Socket x Fipt x Socket

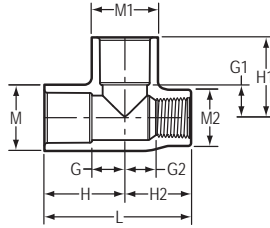

Part Number	Size	G	G1	G2	H	H1	H2	L	M	M1	M2	Approx. Wt. (Lbs.)
403-095	3/4x1/2x3/4	11/16	11/16	11/16	1-11/16	1-11/16	1-3/8	3-3/32	1-13/32	1-13/32	1-3/16	.15

## SPECIAL REINFORCED REDUCING TEE

Socket x SR Fipt x Socket

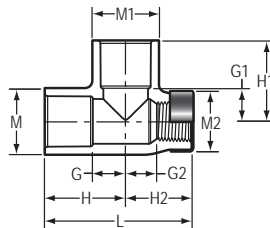

Part Number	Size	G	G1	G2	H	H1	H2	L	M	M1	M2	Approx. Wt. (Lbs.)
403-095SR	3/4x1/2x3/4	11/16	11/16	11/16	1-11/16	1-11/16	1-13/32	3-1/8	1-13/32	1-13/32	1-7/32	.16

## TEE

Fipt x Fipt x Fipt

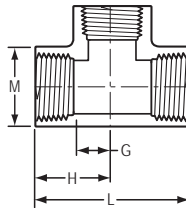

Part Number	Size	G	H	L	M	Approx. Wt. (Lbs.)
405-005	1/2	17/32	1-1/4	2-1/2	1-3/32	.08
405-007	3/4	19/32	1-3/8	2-3/4	1-9/32	.10
405-010	1	11/16	1-19/32	3-3/16	1-23/32	.19
405-012	1-1/4	15/16	1-15/16	3-7/8	2-7/32	.48
405-015	1-1/2	1	2	4-1/32	2-7/32	.34
405-020	2	1-1/4	2-5/16	4-19/32	2-23/32	.56





**VENTURIED TEE**

1" Socket x 3/4" Socket (1" Spigot) x 3/4" Socket (1" Spigot)

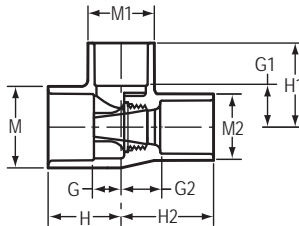

Part Number	Size	G	G1	G2	H	H1	H2	M	M1	M2	Approx. Wt. (Lbs.)
473-825	1x3/4x3/4	19/32	27/32	3/4	1-1/2	1-11/16	1-25/32	1-5/8	1-5/16	1-5/16	.15

**MANIFOLD TEE**

Spigot x Socket x Mipt

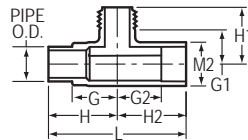

Part Number	Size	G	G1	G2	H	H1	H2	L	M2	Approx. Wt. (Lbs.)
476-010	1	1-23/32	1-11/32	1-11/16	2-5/8	2-5/32	2-5/8	5-1/4	1-21/32	.24

**MANIFOLD TEE**

Spigot x Socket x Fipt

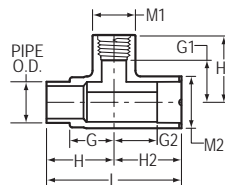

Part Number	Size	G	G1	G2	H	H1	H2	L	M1	M2	Approx. Wt. (Lbs.)
477-010	1	1-23/32	1-1/4	1-11/16	2-5/8	2-5/32	2-5/8	5-1/4	1-21/32	1-21/32	.27

**O-RING SEALED MANIFOLD TEE**

O-ring Sealed Mipt x Fipt x Mipt

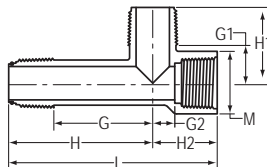

Part Number	Size	G	G1	G2	H	H1	H2	L	M	Approx. Wt. (Lbs.)
451A-010	1	2-19/32	31/32	3/4	3-13/16	1-31/32	1-11/16	5-1/2	1-21/32	.19



# PVC WHITE SCHEDULE 40 FITTINGS UNIONS & SADDLES

## 90° ELBOW

Socket x Socket

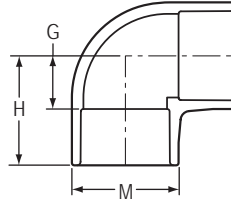

Part Number	Size	G	H	M	Approx. Wt. (Lbs.)
406-003	3/8	3/8	1-1/8	7/8	.03
406-005	1/2	1/2	1-1/4	1-1/8	.05
406-007	3/4	9/16	1-1/2	1-11/32	.07
406-010	1	11/16	1-13/16	1-5/8	.12
406-012	1-1/4	31/32	2-5/32	2	.20
406-015	1-1/2	1-1/16	2-11/32	2-1/4	.25
406-020	2	1-15/32	2-27/32	2-3/4	.42
406-025	2-1/2	1-1/2	3-1/4	3-11/32	.73
406-030	3	1-27/32	3-23/32	4	1.03
406-040	4	2-13/32	4-13/32	5-1/32	1.73
406-045F	4-1/2	8-5/8	6-1/8	5-7/16	3.13
406-050	5	3-1/16	6-1/8	6-5/32	3.58
406-060	6	3-17/32	6-9/16	7-9/32	4.52
406-080	8	4-7/16	8-15/32	9-11/32	8.70
406-100	10	5-13/16	10-27/32	11-19/32	15.75
406-100F	10	9-1/2	14-3/4	11-1/2	17.40
406-120	12	7-1/16	13-9/16	14-1/4	27.98
406-120F	12	10-1/2	16-3/4	13-9/16	25.94
406-140F	14	12-1/4	19-1/4	14-7/8	47.26
406-160F	16	14-1/8	22-1/8	17	69.70
406-180F	18	17-1/4	26-1/4	19-1/8	104.20
406-200F	20	18-3/4	28-3/4	21-3/16	131.93
406-240F	24	22-1/4	34-1/4	25-3/8	216.00

# PVC WHITE SCHEDULE 40 FITTINGS UNIONS & SADDLES



## REDUCING 90° ELBOW

Socket x Socket

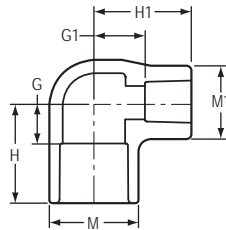

Part Number	Size	G	G1	H	H1	M	M1	Approx. Wt. (Lbs.)
406-053	3/8x1/2	11/32	9/16	1-19/32	2-1/16	7/8	1-1/8	.06
406-101	3/4x1/2	1/2	19/32	1-1/2	1-11/32	1-5/16	1-3/32	.06
D406-101	3/4x1/2	1/2	11/16	1-1/2	1-15/16	1-5/16	1-1/8	.08
406-130	1x1/2	9/16	1-1/16	1-11/16	1-13/16	1-5/8	1-1/8	.08
D406-130	1x1/2	9/16	19/32	1-11/16	1-27/32	1-5/8	1-3/32	.13
406-131	1x3/4	21/32	23/32	1-25/32	1-23/32	1-19/32	1-5/16	.12
406-166	1-1/4x1/2	9/16	1	1-13/16	1-3/4	2	1-3/32	.11
D406-166	1-1/4x1/2	9/16	1	1-25/32	2-1/4	2	1-3/32	.14
406-167	1-1/4x3/4	23/32	1	1-31/32	1-15/16	2	1-5/16	.13
406-168	1-1/4x1	11/16	7/8	1-15/16	2	2	1-21/32	.16
406-209	1-1/2x1/2	17/32	1-27/32	1-3/32	1-27/32	2-7/32	1-3/32	.15
406-211	1-1/2x1	11/16	1-3/32	2-1/8	2-5/32	2-1/4	1-5/8	.20
406-212	1-1/2x1-1/4	31/32	1-3/32	2-9/32	2-11/32	2-7/32	1-31/32	.24
406-249	2x1	27/32	1-11/32	2-7/32	2-15/32	2-23/32	1-19/32	.26
406-250	2x1-1/4	1-1/32	1-7/16	2-13/32	2-21/32	2-23/32	1-31/32	.31
406-251	2x1-1/2	1-1/8	1-5/16	2-15/32	2-9/16	2-3/4	2-1/4	.32
406-251N	2x1-1/2(2)	1-1/16	1-21/32	2-7/16	2-15/16	2-3/4	2-3/8	.43
406-292	2-1/2x2	1-1/4	1-1/2	3	2-7/8	3-11/32	2-23/32	.56
406-292N	2-1/2x2(2-1/2)	1-1/4	2-9/32	3	3-3/16	3-5/16	2-7/8	.71

## 90° SWEEP ELBOW

Socket x Socket

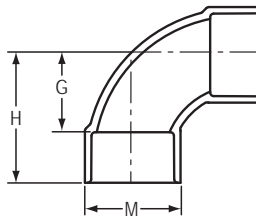

Part Number	Size	G	H	M	Approx. Wt. (Lbs.)
406-005S	1/2	27/32	1-23/32	1-3/16	.08
406-007S	3/4	1-1/32	2-1/32	1-13/32	.12
406-010S	1	1-5/16	2-7/16	1-23/32	.20
406-012S	1-1/4	1-9/16	2-13/16	2-3/32	.30
406-015S	1-1/2	1-3/4	3-5/32	2-11/32	.36
406-020S	2	2-5/16	3-13/16	2-7/8	.68
406-025S	2-1/2	3-3/16	4-31/32	3-11/32	.88
406-030S	3	3-1/32	4-15/16	4	1.25



# PVC WHITE SCHEDULE 40 FITTINGS UNIONS & SADDLES

## LONG SWEEP ELBOW

Socket x Socket

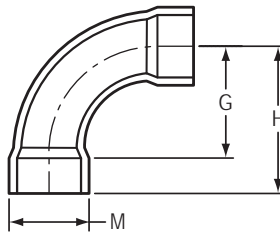

Part Number	Size	G	H	M	Approx. Wt. (Lbs.)
406-025LSF	2-1/2	5-7/16	7-7/16	3-1/4	1.26
406-030LSF	3	6-3/8	8-5/8	3-15/16	1.87
406-040LSF	4	8-3/8	10-5/8	5	2.69
406-060LSF	6	13	16-1/4	7-3/16	6.92
406-080LSF	8	22-7/16	26-11/16	9-1/4	19.43

## 90° ELBOW

Socket x Fipt

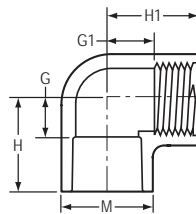

Part Number	Size	G	G1	H	H1	M	Approx. Wt. (Lbs.)
407-005	1/2	1/2	1/2	1-1/4	1-1/4	1-3/32	.06
407-007	3/4	9/16	9/16	1-9/16	1-9/32	1-5/16	.08
407-010	1	11/16	21/32	1-13/16	1-9/16	1-5/8	.14
407-012	1-1/4	7/8	1-5/32	2-1/8	2-1/32	2-1/16	.26
407-015	1-1/2	1	1-1/16	2-5/16	2	2-1/4	.25
407-020	2	1-3/16	1-9/32	2-11/32	2-11/32	2-11/32	.47
407-025	2-1/2	1-1/2	1-1/2	3-1/2	3-1/16	3-5/16	.94
407-030	3	1-13/16	1-31/32	3-11/16	3-21/32	4	1.14
407-040	4	2-5/16	2-15/32	4-5/16	3-15/16	5-1/16	1.85

## SPECIAL REINFORCED

## 90° ELBOW

Socket x SR Fipt

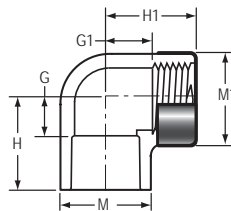

Part Number	Size	G	G1	H	H1	M	M1	Approx. Wt. (Lbs.)
407-005SR	1/2	1/2	9/16	1-1/4	1-9/32	1-3/32	1-7/32	.07
407-007SR	3/4	9/16	21/32	1-13/32	1-13/32	1-3/8	1-13/32	.11
407-010SR	1	19/32	13/16	1-23/32	1-23/32	1-11/16	1-23/32	.20
407-012SR	1-1/4	7/8	1-5/32	2-1/8	2-1/32	2-1/16	2-1/16	.28

# PVC WHITE SCHEDULE 40 FITTINGS UNIONS & SADDLES



## REDUCING 90° ELBOW

Socket x Fipt

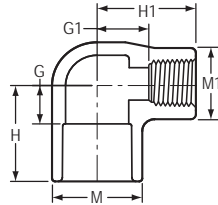

Part Number	Size	G	G1	H	H1	M	M1	Approx. Wt. (Lbs.)
407-053	3/8x1/2	17/32	17/32	1-9/32	1-9/32	7/8	1-3/32	.04
407-074	1/2x3/4	21/32	9/16	1-13/32	1-11/32	1-5/16	1-3/32	.07
407-101	3/4x1/2	9/16	5/8	1-1/2	1-3/8	1-5/16	1-3/32	.07
407-130	1x1/2	7/16	23/32	1-19/32	1-7/16	1-5/8	1-3/32	.12
407-131	1x3/4	11/16	7/8	1-13/16	1-5/8	1-5/8	1-5/16	.11
407-168	1-1/4x1	1	1-1/32	2-1/4	2	2	1-5/8	.19
407-211	1-1/2x1	13/16	1-1/8	2-3/32	2	2-1/4	1-5/8	.21
407-212	1-1/2x1-1/4	15/16	1-1/4	2-1/4	2-7/32	2-3/16	1-15/16	.24
407-249	2x1	13/16	1-9/16	2-5/16	2-3/8	2-3/4	1-11/16	.31
407-250	2x1-1/4	1	1-1/4	2-3/8	2-7/32	2-3/4	2	.31
407-251	2x1-1/2	1-1/8	1-9/16	2-1/2	2-1/2	2-23/32	2-13/32	.42

## SPECIAL REINFORCED REDUCING 90° ELBOW

Socket x SR Fipt

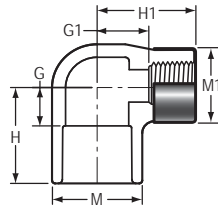

Part Number	Size	G	G1	H	H1	M	M1	Approx. Wt. (Lbs.)
407-249SR	2x1	1-3/16	1-9/16	2-5/16	2-3/8	2-3/4	1-1/16	.33
407-251SR	2x1-1/2	1-1/8	1-19/32	2-1/2	2-17/32	2-23/32	2-7/16	.45



# PVC WHITE SCHEDULE 40 FITTINGS UNIONS & SADDLES

## 90° ELBOW

Fipt x Fipt

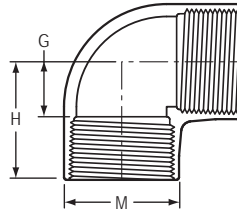

Part Number	Size	G	H	M	Approx. Wt. (Lbs.)
408-005	1/2	1/2	1-7/32	1-3/32	.06
408-007	3/4	1/2	1-1/4	1-5/16	.09
408-010	1	5/8	1-17/32	1-5/8	.16
408-012	1-1/4	1	2	1-31/32	.26
408-015	1-1/2	1	2	1-15/16	.34
408-020	2	1-5/16	2-11/32	2-3/4	.50

## 90° STREET ELBOW

Spigot x Socket

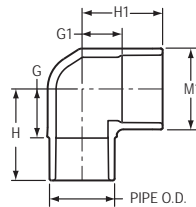

Part Number	Size	G	G1	H	H1	M1	Approx. Wt. (Lbs.)
409-005	1/2	11/16	13/32	1-7/16	1-5/32	1-5/32	.05
409-007	3/4	27/32	17/32	1-27/32	1-17/32	1-11/32	.08
409-010	1	1	23/32	2-1/8	1-13/16	1-5/8	.12
409-012	1-1/4	1-3/16	13/16	2-15/32	2-1/16	1-31/32	.19
409-015	1-1/2	1-11/32	1-1/16	2-5/8	2-3/8	2-1/4	.25
409-020	2	1-19/32	1-1/4	2-31/32	2-5/8	2-23/32	.35
409-025	2-1/2	1-15/32	1-17/32	3-23/32	3-3/8	3-11/32	.76
409-030	3	2-9/32	1-13/16	4-5/32	3-11/16	4	1.09
409-040	4	2-29/32	2-5/16	4-15/16	4-11/32	5-1/16	1.86
409-050	5	4-1/2	3	7-3/4	6	6-1/8	4.36
409-060	6	5-1/4	3-1/2	8-7/8	6-15/16	7-1/2	5.95
409-080	8	6-3/8	4-15/32	10-9/16	8-1/2	9-5/16	10.37
409-080F	8	7-1/2	7-1/2	11-3/4	11-3/4	9-1/4	10.02
409-100F	10	8-1/4	5-3/4	13-1/2	13-3/4	11-1/2	18.20
409-140F	14	12-1/4	12-1/4	19-1/4	19-1/4	14-7/8	39.38
409-160F	16	18-5/8	14-1/8	27-5/8	22-1/8	17	75.48
409-180F	18	21-3/4	17-1/4	31-3/4	26-1/4	19-1/8	115.96
409-200F	20	25-3/4	18-3/4	34-3/4	28-3/4	21-3/16	151.63

# PVC WHITE SCHEDULE 40 FITTINGS UNIONS & SADDLES



## 90° STREET ELBOW

Mipt x Socket

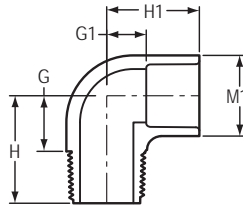

Part Number	Size	G	G1	H	H1	M1	Approx. Wt. (Lbs.)
410-005	1/2	21/32	3/8	1-11/32	1-5/32	1-3/32	.04
410-007	3/4	27/32	15/32	1-17/32	1-15/32	1-5/16	.08
410-010	1	1-1/32	11/16	1-29/32	1-13/16	1-5/8	.13
410-012	1-1/4	1-9/32	25/32	2-7/32	2	1-31/32	.18
410-015	1-1/2	1-13/32	1	2-13/32	2-5/16	2-7/32	.40
410-020	2	1-5/8	1-11/32	2-9/16	2-23/32	2-23/32	.41

## REDUCING 90° STREET ELBOW

Mipt x Socket

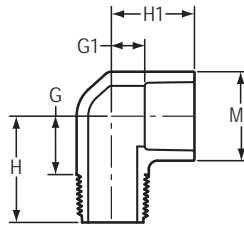

Part Number	Size	G	G1	H	H1	M1	Approx. Wt. (Lbs.)
410-101	3/4x1/2	23/32	13/32	1-7/16	1-1/4	1-3/32	.06
410-102	3/4x1	3/4	1/2	1-3/4	1-11/32	1-5/8	.09

## 11-1/4° ELBOW

Socket x Socket

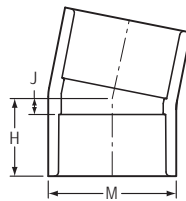

Part Number	Size	H	J	M	Approx. Wt. (Lbs.)
411-005F	1/2	1-5/16	5/16	1-1/16	.05
411-007F	3/4	1-5/16	5/16	1-1/4	.07
411-010F	1	1-9/16	5/16	1-9/16	.10
411-012F	1-1/4	2	1/2	1-5/16	.21
411-015	1-1/2	1-19/32	7/32	2-3/8	.24



# PVC WHITE SCHEDULE 40 FITTINGS UNIONS & SADDLES

## 11-1/4° ELBOW (continued)

Socket x Socket

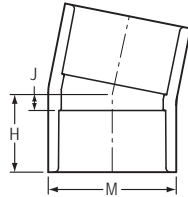

Part Number	Size	H	J	M	Approx. Wt. (Lbs.)
411-015F	1-1/2	2	1/2	2-3/16	.21
411-020	2	1-3/4	1/4	2-13/16	.33
411-025F	2-1/2	2-11/16	11/16	3-1/4	.57
411-030	3	1-7/8	5/16	4-1/8	.88
411-040	4	2-21/32	13/32	5-1/4	1.51
411-045F	4-1/2	3-1/4	3/4	5-7/16	1.32
411-050F	5	3-13/16	13/16	6-1/16	2.18
411-060F	6	4-1/4	1	7-3/16	2.75
411-080F	8	5-5/16	1-1/16	9-1/4	5.29
411-100F	10	6-27/32	1-15/32	11-1/2	9.42
411-120F	12	7-31/32	1-23/32	13-5/8	14.08
411-140F	14	8-3/4	1-3/4	14-7/8	18.71
411-160F	16	10-1/4	2-1/4	17	28.40
411-180F	18	12	3-1/8	19-1/8	45.02
411-200F	20	13-3/8	3-3/8	21-3/16	57.11
411-240F	24	15-1/8	4-1/8	25-1/2	90.42

## 90° STREET ELBOW

Mipt x Fipt

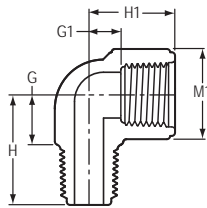

Part Number		Size	G	G1	H	H1	M1	Approx. Wt. (Lbs.)	
PVC	HDPE							PVC	HDPE
412-005	M412-005	1/2	23/32	11/32	1-13/32	1-1/16	1-1/8	.05	.04
412-007	M412-007	3/4	13/16	7/16	1-17/32	1-3/16	1-11/32	.07	.04
412-010	M412-010	1	15/16	9/16	1-25/32	1-7/16	1-5/8	.13	.08
412-012	M412-012	1-1/4	1-7/32	7/8	2-7/32	1-7/8	1-31/32	.19	.15
412-015	M412-015	1-1/2	1-11/32	1-1/8	2-11/32	2-1/8	2-9/32	.24	.20
412-020	N/A	2	1-19/32	1-1/4	2-3/4	2-5/16	2-23/32	.39	---
412-030	N/A	3	2-25/32	1-7/8	4-15/32	3	4-3/4	1.50	---



# PVC WHITE SCHEDULE 40 FITTINGS UNIONS & SADDLES



## 90° STREET ELBOW (Short Pattern)

Mipt x Fipt

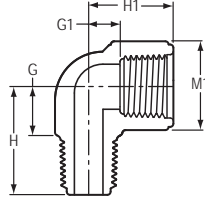

Part Number - HDPE	Size	G	G1	H	H1	M1	Approx. Wt. (Lbs.)
MS412-005	1/2	21/32	5/16	1-3/16	31/32	1-1/16	.02
MS412-007	3/4	3/4	7/16	1-5/16	1-3/32	1-9/32	.03
MS412-010	1	7/8	9/16	1-9/16	1-3/8	1-9/16	.06
MS412-101	3/4x1/2	21/32	1/2	1-7/32	1-1/8	1	.03

## SIDE OUTLET ELBOW

Socket x Socket x Socket

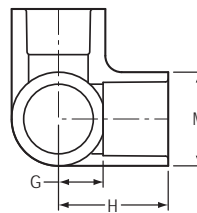

Part Number	Size	G	H	M	Approx. Wt. (Lbs.)
413-005	1/2	1/2	1-1/4	1-3/32	.06
413-007	3/4	9/16	1-9/16	1-5/16	.10
413-010	1	3/16	1-7/8	1-5/8	.17
413-015	1-1/2	1-1/16	2-5/16	2-1/4	.31
413-020	2	1-5/16	2-5/8	2-3/4	.47

## SIDE OUTLET ELBOW

Socket x Socket x Fipt

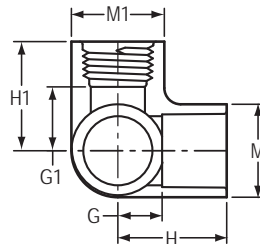

Part Number	Size	G	G1	H	H1	M	M1	Approx. Wt. (Lbs.)
414-005	1/2	1/2	1/2	1-1/4	1-1/4	1-3/32	1-3/32	.07
414-007	3/4	9/16	5/8	1-9/16	1-7/16	1-9/32	1-9/32	.10



# PVC WHITE SCHEDULE 40 FITTINGS UNIONS & SADDLES

## SIDE OUTLET ELBOW (continued)

Socket x Socket x Fipt

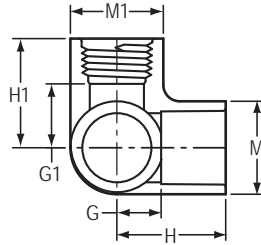

Part Number	Size	G	G1	H	H1	M	M1	Approx. Wt. (Lbs.)
414-101	3/4x3/4x1/2	9/16	21/32	1-9/16	1-13/32	1-5/16	1-1/16	.09
414-130	1x1x1/2	11/16	3/4	1-13/16	1-9/16	1-5/8	1-1/16	.14

## 30° ELBOW

Socket x Socket

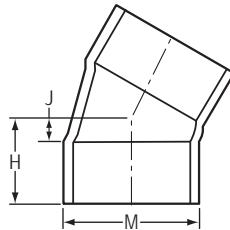

Part Number	Size	H	J	M	Approx. Wt. (Lbs.)
415-005F	1/2	1-3/8	3/8	1-1/16	0.04
415-007F	3/4	1-7/16	7/16	1-1/4	0.07
415-010F	1	1-3/4	1/2	1-9/16	0.12
415-012F	1-1/4	2-1/8	5/8	1-15/16	0.17
415-015F	1-1/2	2-3/16	11/16	2-3/16	0.19
415-020F	2	2-1/2	3/4	2-11/16	0.34
415-025F	2-1/2	2-15/16	15/16	3-1/4	0.62
415-030F	3	3-5/16	1-1/16	3-15/16	0.93
415-040F	4	3-7/16	1-3/16	5	1.39
415-045F	4-1/2	3-3/4	1-1/4	5-7/16	1.48
415-050F	5	4-5/16	1-5/16	6-1/16	2.27
415-060F	6	4-7/8	1-5/8	7-3/16	3.25
415-080F	8	6-1/8	1-7/8	9-1/4	5.40
415-100F	10	7-1/4	2	11-1/2	10.67
415-120F	12	9-5/16	2-9/16	13-1/2	16.56
415-140F	14	9-3/4	2-3/4	14-7/8	20.68
415-160F	16	11-7/8	3-7/8	17	32.27
415-180F	18	13-1/2	4-1/2	19-1/8	48.74
415-200F	20	15-1/4	5-1/4	21-1/4	63.01
415-240F	24	17	6	25-1/2	104.12

# PVC WHITE SCHEDULE 40 FITTINGS UNIONS & SADDLES



## 22-1/2° ELBOW

Socket x Socket

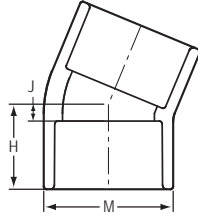

Part Number	Size	H	J	M	Approx. Wt. (Lbs.)
416-005	1/2	1-1/16	3/16	1-5/32	.06
416-007	3/4	1-3/16	3/16	1-7/16	.09
416-010	1	1-3/8	9/32	1-23/32	.13
416-012	1-1/4	1-1/2	11/32	2-3/32	.21
416-015	1-1/2	1-11/32	11/32	2-11/32	.26
416-020	2	1-23/32	3/8	2-25/32	.24
416-025	2-1/2	2-1/4	1/2	3-1/2	.69
416-025F	2-1/2	2-13/16	13/16	3-1/4	.63
416-030	3	2-13/32	9/16	4-5/32	.83
416-040	4	2-27/32	19/32	5-3/16	1.69
416-045F	4-1/2	3-9/16	1-1/16	5-7/16	1.59
416-050F	5	4-1/8	1-1/8	6-1/16	2.27
416-060	6	4-9/16	1-9/32	7-3/16	4.39
416-060F	6	4-5/8	1-3/8	7-3/16	3.25
416-080	8	5-7/8	1-3/4	9-3/4	8.38
416-080F	8	5-13/16	1-9/16	9-1/4	5.73
416-100F	10	7-7/16	2-3/16	11-1/2	10.04
416-120F	12	8-1/2	2-1/4	13-9/16	15.74
416-140F	14	9-1/2	2-1/2	15	19.69
416-160F	16	11-1/4	3-1/4	17	30.98
416-180F	18	13-1/2	4-1/2	19-3/16	45.38
416-200F	20	14-1/2	4-1/2	21-3/16	59.07
416-240F	24	16-1/8	5-1/8	25-1/2	98.64



# PVC WHITE SCHEDULE 40 FITTINGS UNIONS & SADDLES

## 22-1/2° STREET ELBOW

Spigot x Socket

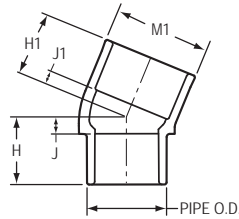

Part Number	Size	H	H1	J	J1	M1	Approx. Wt. (Lbs.)
442-005	1/2	1-1/16	1	1/4	1/4	1-5/32	.05
442-010	1	1-15/32	1-3/8	11/32	9/32	1-11/16	.13
442-012	1-1/4	1-1/2	1-3/8	3/16	1-11/16	2-1/16	.20
442-015	1-1/2	1-21/32	1-7/8	9/32	1/2	2-3/8	.26
442-020	2	2	1-29/32	15/32	13/32	2-7/8	.40
442-025F	2-1/2	4-9/16	1-13/16	13/16	3/16	3-1/4	.81
442-030	3	2-1/2	2-5/16	21/32	7/16	4-5/32	.95
442-040	4	4-3/8	2-7/8	1-7/8	5/8	5-1/4	2.14
442-060	6	5-11/16	3-15/16	2-3/8	7/8	7-5/8	5.87
442-080	8	7-3/8	5-1/8	3-1/8	1-1/8	9-3/4	11.34

## 45° ELBOW

Socket x Socket

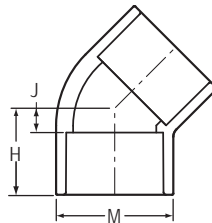

Part Number	Size	H	J	M	Approx. Wt. (Lbs.)
417-005	1/2	1-1/8	11/32	1-3/32	.04
417-007	3/4	1-3/8	7/16	1-5/16	.07
417-010	1	1-1/2	15/32	1-21/32	.11
417-012	1-1/4	1-19/32	3/8	1-31/32	.15
417-015	1-1/2	1-29/32	19/32	2-1/4	.22
417-020	2	2-1/16	11/16	2-3/4	.31
417-025	2-1/2	2-7/16	21/32	3-11/32	.56
417-030	3	2-27/32	27/32	4	.84
417-040	4	3-3/32	1-3/32	5-1/32	1.22
417-045F	4-1/2	4-3/16	1-11/16	5-7/16	1.59
417-050	5	4-3/8	1-3/8	6-1/16	2.41
417-060	6	4-3/4	1-11/16	7-9/32	3.47
417-080	8	6-7/16	2	9-9/32	6.56
417-100	10	8-1/8	3-1/8	11-1/2	20.72

# PVC WHITE SCHEDULE 40 FITTINGS UNIONS & SADDLES



## 45° ELBOW (continued)

Socket x Socket

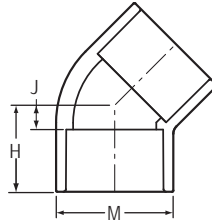

Part Number	Size	H	J	M	Approx. Wt. (Lbs.)
417-120	12	9-19/32	3-3/32	14-5/16	34.15
417-120F	12	9-19/32	3-11/32	13-9/16	17.39
417-140F	14	10-7/8	3-7/8	14-7/8	24.61
417-160F	16	12-1/2	4-1/2	17	34.85
417-180F	18	14-7/8	5-7/8	19-1/8	52.10
417-200F	20	16-1/2	6-1/2	21-3/16	68.92
417-240F	24	19-7/8	7-7/8	25-1/2	112.34

## 45° STREET ELBOW

Spigot x Socket

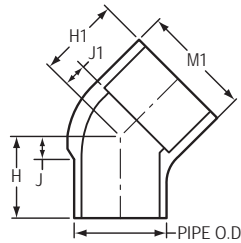

Part Number	Size	H	H1	J	J1	M1	Approx. Wt. (Lbs.)
427-005	1/2	1-9/32	1-9/32	11/32	13/32	1-3/16	.06
427-007	3/4	1-1/2	1-17/32	7/16	17/32	1-13/32	.09
427-010	1	1-19/32	1-21/32	13/32	17/32	1-23/32	.10
427-012	1-1/4	1-25/32	1-29/32	1/2	21/32	2-3/32	.22
427-015	1-1/2	2-1/32	2-3/32	19/32	23/32	2-11/32	.19
427-020	2	2	2	5/8	15/32	2-23/32	.30
427-025	2-1/2	2-5/8	2-5/8	3/4	7/8	3-11/32	.59
427-030	3	2-31/32	3-1/32	1	1-7/32	4-5/32	1.19
427-040	4	3-21/32	3-13/16	1-9/32	1-9/16	5-3/16	2.07
427-050	5	6-1/8	4-3/8	2-7/8	1-3/8	6-1/16	3.49
427-060	6	5-1/4	6-1/4	1-3/4	3	7-5/8	6.16
427-080	8	6-5/8	5-31/32	2-19/32	1-3/4	9-3/4	10.60



# PVC WHITE SCHEDULE 40 FITTINGS UNIONS & SADDLES

## 15° ELBOW Socket x Socket

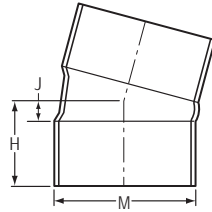

Part Number	Size	H	J	M	Approx. Wt. (Lbs.)
418-005F	1/2	1-5/16	5/16	1-1/16	.05
418-007F	3/4	1-5/16	5/16	1-1/4	.07
418-010F	1	1-5/8	3/8	1-9/16	.11
418-012F	1-1/4	2	1/2	1-15/16	.14
418-015F	1-1/2	2	1/2	2-3/16	.20
418-020F	2	2-5/16	9/16	2-11/16	.34
418-025F	2-1/2	2-3/4	3/4	3-1/4	.57
418-030F	3	3	3/4	3-15/16	.82
418-040F	4	3	13/16	5	1.39
418-045F	4-1/2	3-3/8	7/8	5-7/16	1.36
418-050F	5	3-7/8	7/8	6-1/16	1.88
418-060F	6	4-3/8	1-1/8	7-3/16	2.95
418-080F	8	5-1/2	1-1/4	9-1/4	5.29
418-100F	10	6-31/32	1-19/32	11-1/2	9.42
418-120F	12	8-1/4	2	13-9/16	14.91
418-140F	14	9-1/8	2-1/8	15	19.69
418-160F	16	10-5/8	2-5/8	17	29.69
418-180F	18	12-1/4	3-1/4	19-1/8	43.70
418-200F	20	13-5/8	3-5/8	21-1/4	57.11
418-240F	24	14-7/8	3-7/8	25-1/2	90.42

# PVC WHITE SCHEDULE 40 FITTINGS UNIONS & SADDLES



## 60° ELBOW

Socket x Socket

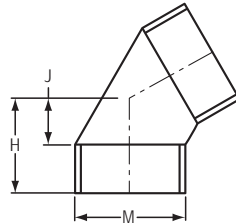

Part Number	Size	H	J	M	Approx. Wt. (Lbs.)
424-005F	1/2	1-5/8	5/8	1-1/16	.13
424-007F	3/4	1-11/16	11/16	1-1/4	.07
424-010F	1	2	3/4	1-9/16	.17
424-012F	1-1/4	2-1/2	1	1-15/16	.38
424-015F	1-1/2	2-9/16	1-1/16	2-3/16	.27
424-020F	2	2-15/16	1-3/16	2-11/16	.59
424-025F	2-1/2	3-1/2	1-1/2	3-1/4	1.38
424-030F	3	3-5/8	1-3/8	3-15/16	1.70
424-040F	4	4-1/4	2	5	1.52
424-045F	4-1/2	4-5/8	2-1/8	5-7/16	2.96
424-050F	5	5-5/16	2-5/16	6-1/16	2.42
424-060F	6	6-1/16	2-13/16	7-3/16	6.20
424-080F	8	7-5/8	3-3/8	9-1/4	11.89
424-100F	10	9-1/4	4	11-1/2	20.09
424-120F	12	11	4-3/4	13-9/16	31.47
424-140F	14	17-1/2	10-1/2	15	42.32
424-160F	16	20-1/4	12-1/4	17	36.39
424-180F	18	22-7/8	13-7/8	19-3/16	94.11
424-200F	20	26-1/4	16-1/4	21-1/4	122.09
424-240F	24	31	20	25-1/2	199.58



# PVC WHITE SCHEDULE 40 FITTINGS UNIONS & SADDLES

## CROSS

Socket x Socket x Socket x Socket

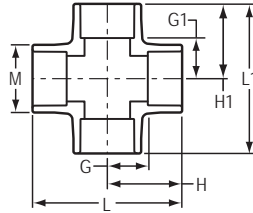

Part Number	Size	G	G1	H	H1	L	L1	M	Approx. Wt. (Lbs.)
420-005	1/2	17/32	17/32	1-9/32	1-9/32	2-17/32	2-17/32	1-3/32	.07
420-007	3/4	9/16	9/16	1-9/16	1-9/16	3-1/8	3-1/8	1-5/16	.12
420-010	1	13/16	13/16	1-15/16	1-15/16	3-7/8	3-7/8	1-5/8	.25
420-012	1-1/4	1-3/32	1-3/32	2-11/32	2-11/32	4-23/32	4-23/32	2-1/16	.43
420-015	1-1/2	1-1/4	1-1/4	2-19/32	2-19/32	5-5/32	5-5/32	2-5/16	.54
420-020	2	1-17/32	1-17/32	2-29/32	2-29/32	5-27/32	5-27/32	2-13/16	.78
420-025	2-1/2	1-21/32	1-21/32	3-21/32	3-21/32	7-11/32	7-11/32	3-3/8	1.61
420-030	3	2-1/16	2-1/16	3-15/16	3-15/16	7-29/32	7-29/32	4-1/32	1.74
420-040	4	2-1/2	2-1/2	4-1/2	4-1/2	9-1/32	9-1/32	5-1/32	3.22
420-050F	5	6	6	9	9	18	18	6-1/16	13.68
420-060F	6	6-3/16	6-3/16	9-7/16	9-7/16	18-7/8	18-7/8	7-3/16	12.36
420-080F	8	8-9/16	8-9/16	12-13/16	12-13/16	25-5/8	25-5/8	9-1/4	26.10
420-100F	10	9-7/8	9-3/8	15-1/8	14-5/8	30-1/4	29-1/4	11-1/2	43.81
420-120F	12	10-3/4	10-3/16	17	16-7/16	34	32-7/8	13-9/16	66.22
420-140F	14	11-1/4	11	18-3/8	18	36-3/4	36	14-7/8	84.87
420-160F	16	15	12-7/8	23	20-7/8	46	41-3/4	17	128.99
420-180F	18	15-7/8	13-3/8	24-7/8	22-3/8	49-3/4	44-3/4	19-1/8	176.46
420-200F	20	18-1/4	15-1/2	28-1/4	25-1/2	56-1/2	51	21-3/16	153.70
420-240F	24	21-1/8	17-1/2	33-1/8	29-1/2	66-1/4	59	25-3/8	253.36



# PVC WHITE SCHEDULE 40 FITTINGS UNIONS & SADDLES



## REDUCING CROSS

Socket x Socket x Socket x Socket

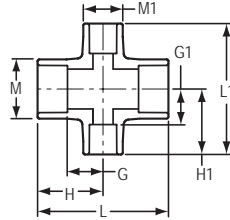

Part Number	Size	G	G1	H	H1	L	L1	M	M1	Approx. Wt. (Lbs.)
420-101 <sup>1</sup>	3/4x3/4x1/2x1/2	1-7/16	1-1/16	1-9/16	1-13/16	3-1/8	3-5/8	1-5/16	1-5/16	.17
420-131	1x1x3/4x3/4	23/32	5/8	1-5/8	1-5/8	3-1/4	3-1/4	1-7/8	1-17/32	.30
420-167 <sup>1</sup>	1-1/4x1-1/4x3/4x3/4	1-1/8	1-21/32	2-11/32	2-21/32	4-11/16	5-5/16	2-1/32	2-1/32	.71
420-168 <sup>1</sup>	1-1/4x1-1/4x1x1	1-3/32	1-9/16	2-11/32	2-5/8	4-23/32	5-7/32	2-1/16	2-1/16	.56
420-248	2x2x3/4x3/4	11/16	1-7/16	2-7/32	2-7/16	4-13/32	4-7/8	2-29/32	1-13/32	.55
420-249	2x2x1x1	13/16	1-3/8	2-3/16	2-1/2	4-3/8	5	2-3/4	1-5/8	.39
420-250 <sup>1</sup>	2x2x1-1/4x1-1/4	1-9/16	2-1/16	2-15/16	3-15/16	5-27/32	6-5/8	2-13/16	2-13/16	1.34
420-251 <sup>1</sup>	2x2x1-1/2x1-1/2	1-17/32	1-25/32	2-29/32	3-1/8	5-13/16	6-1/4	2-25/32	2-25/32	1.18
420-289 <sup>1</sup>	2-1/2x2-1/2x1x1	1-21/32	2-27/32	3-21/32	3-31/32	7-11/32	7-29/32	3-3/8	3-3/8	2.31
420-335 <sup>1</sup>	3x3x1x1	1-15/16	3-1/4	3-15/16	4-3/8	7-7/8	8-3/4	4	4	3.12
420-336 <sup>1</sup>	3x3x1-1/4x1-1/4	2	3-1/8	3-15/16	4-3/8	7-7/8	8-3/4	4	4	3.11
420-337 <sup>1</sup>	3x3x1-1/2x1-1/2	1-31/32	3-1/16	3-31/32	4-3/8	7-15/16	8-23/32	4-1/32	4-1/32	3.14
420-338 <sup>1</sup>	3x3x2x2	2-1/16	2-5/8	3-31/32	4-9/32	7-29/32	8-9/16	4-1/32	4-1/32	2.72
420-339 <sup>1</sup>	3x3x2-1/2x2-1/2	1-15/16	2-11/32	3-15/16	4-11/32	7-7/8	8-11/16	4	4	2.97
420-420 <sup>1</sup>	4x4x2x2	2-1/2	3-17/32	4-1/2	4-29/32	9-1/32	9-13/16	5-1/32	5-1/4	4.99
420-420F	4x4x2x2	4-1/2	4-1/4	6-3/4	6	13-1/2	12	5-1/16	2-11/16	3.37
420-421 <sup>1</sup>	4x4x2-1/2x2-1/2	2-1/2	2-15/16	4-1/2	4-15/16	9	9-7/8	5	5	5.08
420-422 <sup>1</sup>	4x4x3x3	2-1/2	2-15/16	4-1/2	4-15/16	9	9-7/8	5	5	4.90
420-528F	6x6x2x2	5-1/8	5-5/16	8-3/8	7-1/16	16-3/4	14-1/8	7-3/16	2-11/16	7.71
420-529F	6x6x2-1/2x2-1/2	5-3/8	5-13/16	8-5/8	7-13/16	17-1/4	15-5/8	7-3/16	3-1/4	9.21
420-530F	6x6x3x3	5-7/8	6-1/16	9-1/8	8-5/16	18-1/4	16-5/8	7-3/16	3-15/16	9.21
420-532F	6x6x4x4	5	6-3/8	8-1/4	8-5/8	16-1/2	17-1/4	7-3/16	5	10.35
420-578F	8x8x2x2	5-5/16	6-1/4	9-9/16	8	19-1/8	16	9-1/4	2-11/16	11.23
420-580F	8x8x3x3	5-11/16	7	9-15/16	9-1/4	19-7/8	18-1/2	9-1/4	3-15/16	14.45
420-582F	8x8x4x4	6-5/16	7-5/16	10-9/16	9-9/16	21-1/8	19-1/8	9-1/4	5	16.52
420-585F	8x8x6x6	7-5/16	7-3/8	11-9/16	10-5/8	23-1/8	21-1/4	9-1/4	7-3/16	20.11
420-621F	10x10x2x2	4-7/8	7-1/4	10-1/8	9	20-1/4	18	11-1/2	2-11/16	16.08
420-622F	10x10x2-1/2	5-5/8	7-3/4	10-7/8	9-3/4	21-3/4	19-1/2	11-1/2	3-1/4	20.48
420-623F	10x10x3x3	5-3/8	8	10-5/8	10-1/4	21-1/4	20-1/2	11-1/2	3-15/16	22.78
420-624F	10x10x4x4	5-7/8	8-5/16	11-1/8	10-9/16	22-1/4	21-1/8	11-1/2	5	22.73
420-626F	10x10x6x6	6-7/8	8-3/8	12-1/8	11-5/8	24-1/4	23-1/4	11-1/2	7-3/16	30.13
420-628F	10x10x8x8	8-1/2	8-5/16	13-3/4	12-9/16	27-1/2	25-1/8	11-1/2	9-1/4	35.40
420-661F	12x12x2x2	5-1/4	8-1/4	11-1/2	10	23	20	13-9/16	2-11/16	29.47
420-662F	12x12x2-1/2x2-1/2	5-3/4	8-3/4	12	10-3/4	24	21-1/2	13-9/16	3-1/4	29.06
420-663F	12x12x3x3	5-3/4	9	12	11-1/4	24	22-1/2	13-9/16	3-15/16	34.47
420-664F	12x12x4x4	7	9-5/16	13-1/4	11-9/16	26-1/2	23-1/8	13-9/16	5	33.96
420-666F	12x12x6x6	8	9-3/8	14-1/4	12-5/8	28-1/2	25-1/4	13-9/16	7-3/16	39.69
420-668F	12x12x8x8	8-3/4	9-5/16	15	13-9/16	30	27-1/8	13-9/16	9-1/4	45.81
420-670F	12x12x10x10	10-1/4	10-3/8	16-1/2	15-5/8	33	31-1/4	13-9/16	11-1/2	53.90
420-691F	14x14x2x2	5-7/8	8-13/16	12-7/8	10-9/16	25-3/4	21-1/8	14-7/8	2-11/16	34.95

<sup>1</sup> Outlet sized with bushing



# PVC WHITE SCHEDULE 40 FITTINGS UNIONS & SADDLES

## REDUCING CROSS

Socket x Socket x Socket x Socket

(continued)

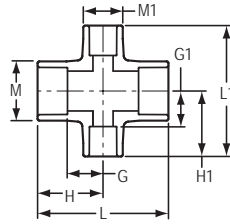

Part Number	Size	G	G1	H	H1	L	L1	M	M1	Approx. Wt. (Lbs.)
420-693F	14x14x3x3	6-1/2	9-9/16	13-1/2	11-13/16	27	23-5/8	14-7/8	3-15/16	38.68
420-694F	14x14x4x4	7-3/8	9-7/8	14-3/8	12-1/8	28-3/4	24-1/4	14-7/8	5	40.35
420-696F	14x14x6x6	7-7/8	9-15/16	14-7/8	13-3/16	29-3/4	26-3/8	14-7/8	7-3/16	46.98
420-698F	14x14x8x8	8-7/8	9-7/8	15-7/8	14-1/8	31-3/4	28-1/4	14-7/8	9-1/4	44.67
420-700F	14x14x10x10	10-3/8	10-15/16	17-3/8	16-3/16	34-3/4	32-3/8	14-7/8	11-1/2	44.43
420-702F	14x14x12x12	11-3/8	10-3/4	18-3/8	17	36-3/4	34	14-7/8	13-9/16	66.57
420-751F	16x16x2x2	6-3/8	9-3/4	14-3/8	11-1/2	28-3/4	23	17	2-11/16	50.82
420-753F	16x16x3x3	6-1/2	10-1/2	14-1/2	12-3/4	29	25-1/2	17	3-15/16	56.76
420-754F	16x16x4x4	8	10-13/16	16	13-1/16	32	26-1/8	17	5	62.49
420-756F	16x16x6x6	9	10-7/8	17	14-1/8	34	28-1/4	17	7-3/16	66.61
420-758F	16x16x8x8	10	10-13/16	18	15-1/16	36	30-1/8	17	9-1/4	77.97
420-760F	16x16x10x10	11	11-7/8	19	17-1/8	38	34-1/4	17	11-1/2	86.09
420-762F	16x16x12x12	12	11-11/16	20	17-15/16	40	35-7/8	17	13-9/16	91.41
420-764F	16x16x14x14	13	11-15/16	21	18-15/16	42	37-7/8	17	14-7/8	109.43
420-781F	18x18x2x2	6-1/4	10-11/16	15-1/4	12-7/16	30-1/2	24-7/8	19-1/8	2-11/16	66.00
420-783F	18x18x3x3	7-1/4	11-7/16	16-1/4	13-11/16	32-1/2	27-3/8	19-1/8	3-15/16	73.00
420-784F	18x18x4x4	7-3/4	11-3/4	16-3/4	14	33-1/2	28	19-1/8	5	76.00
420-786F	18x18x6x6	8-3/4	11-13/16	17-3/4	15-1/16	35-1/2	30-1/8	19-1/8	7-3/16	84.00
420-788F	18x18x8x8	9-3/4	11-3/4	18-3/4	16	37-1/2	32	19-1/8	9-1/4	93.50
420-790F	18x18x10x10	10-3/4	12-13/16	19-3/4	18-1/16	39-1/2	36-1/8	19-1/8	11-1/2	---
420-792F	18x18x12x12	11-3/4	12-5/8	20-3/4	18-7/8	41-1/2	37-3/4	19-1/8	13-9/16	111.65
420-794F	18x18x14x14	12-7/8	12-7/8	21-7/8	19-7/8	43-3/4	39-3/4	19-1/8	14-7/8	129.34
420-796F	18x18x16x16	13-7/8	13-13/16	22-7/8	21-13/16	45-3/4	43-5/8	19-1/8	17	145.80
420-811F	20x20x2x2	6-3/4	12-7/16	16-3/4	14-3/16	33-1/2	28-3/8	21-3/16	2-11/16	83.00
420-813F	20x20x3x3	7-1/4	12-7/16	17-1/4	14-11/16	34-1/2	29-3/8	21-3/16	3-15/16	92.00
420-814F	20x20x4x4	8-1/4	12-3/4	18-1/4	15	36-1/2	30	21-3/16	5	95.82
420-816F	20x20x6x6	9-1/4	12-13/16	19-1/4	16-1/16	38-1/2	32-1/8	21-3/16	7-3/16	105.00
420-818F	20x20x8x8	10-1/4	12-3/4	20-1/4	17	40-1/2	34	21-3/16	9-1/4	115.00
420-820F	20x20x10x10	11-1/4	13-13/16	21-1/4	19-1/16	42-1/2	38-1/8	21-3/16	11-1/2	126.30
420-822F	20x20x12x12	12-1/4	13-5/8	22-1/4	19-7/8	44-1/2	39-3/4	21-3/16	13-9/16	140.46
420-824F	20x20x14x14	13-1/4	13-7/8	23-1/4	20-7/8	46-1/2	41-3/4	21-3/16	14-7/8	140.77
420-826F	20x20x16x16	14-1/4	14-13/16	24-1/4	22-13/16	48-1/2	45-5/8	21-3/16	17	165.34
420-828F	20x20x18x18	15-1/4	14-3/8	25-1/4	23-3/8	50-1/2	46-3/4	21-3/16	19-1/8	193.92
420-901F	24x24x2x2	8-1/8	14-5/16	20-1/8	16-1/16	40-1/4	32-1/8	25-3/8	2-11/16	156.00
420-903F	24x24x3x3	8-5/8	14-5/6	20-5/8	16-9/16	41-1/4	33-1/8	25-3/8	3-15/16	162.00

# PVC WHITE SCHEDULE 40 FITTINGS UNIONS & SADDLES



## REDUCING CROSS

Socket x Socket x Socket x Socket

(continued)

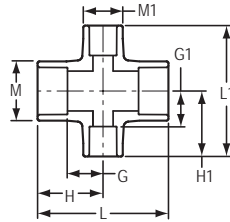

420-904F	24x24x4x4	9-1/8	14-5/8	21-1/8	16-7/8	42-1/4	33-3/4	25-3/8	5	167.00
Part Number	Size	G	G1	H	H1	L	L1	M	M1	Approx. Wt. (Lbs.)
420-906F	24x24x6x6	10-1/8	14-11/16	22-1/8	17-15/16	44-1/4	35-7/8	25-3/8	7-3/16	179.90
420-908F	24x24x8x8	11-1/8	14-5/8	23-1/8	18-7/8	46-1/4	37-3/4	25-3/8	9-1/4	193.00
420-910F	24x24x10x10	12-1/8	15-11/16	24-1/8	20-15/16	48-1/4	41-7/8	25-3/8	11-1/2	190.14
420-912F	24x24x12x12	13-1/8	15-1/2	25-1/8	21-3/4	50-1/4	43-1/2	25-3/8	13-9/16	205.85
420-914F	24x24x14x14	13-3/4	15-3/4	25-3/4	22-3/4	51-1/2	45-1/2	25-3/8	14-7/8	103.61
420-916F	24x24x16x16	14-3/4	16-11/16	26-3/4	24-11/16	53-1/2	49-3/8	25-3/8	17	243.82
420-918F	24x24x18x18	15-3/4	16-1/4	27-3/4	25-1/4	55-1/2	50-1/2	25-3/8	19-1/8	268.14
420-920F	24x24x20x20	16-3/4	17-3/8	28-3/4	27-3/8	57-1/2	54-3/4	25-3/8	21-3/16	292.79

## CROSS

Socket x Mipt x Socket x Mipt

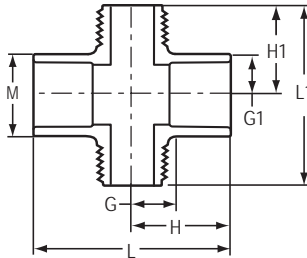

Part Number	Size	G	G1	H	H1	L	L1	M	Approx. Wt. (Lbs.)
421A-010	1x1x1x1	5/8	1	1-5/8	1-7/8	3-13/32	3-3/4	1-5/8	.18

## COUPLING

Socket x Socket

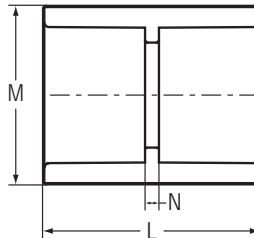

Part Number	Size	L	M	N	Approx. Wt. (Lbs.)
429-003	3/8	2-5/8	7/8	1/8	.03
429-005	1/2	1-19/32	1-3/32	3/32	.03
429-005N	1/2	1-5/8	1-1/16	1/8	.02



# PVC WHITE SCHEDULE 40 FITTINGS UNIONS & SADDLES

## COUPLING Socket x Socket

(continued)

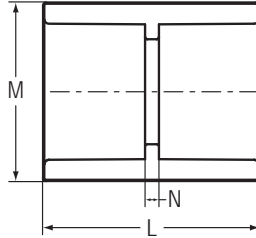

Part Number	Size	L	M	N	Approx. Wt. (Lbs.)
429-007	3/4	2-3/32	1-5/16	3/32	.05
429-007N	3/4	2-3/32	1-5/16	3/32	.05
429-010	1	2-1/8	1-19/32	1/8	.07
429-010N	1	2-11/32	1-21/32	3/32	.10
429-012	1-1/4	2-11/32	1-31/32	3/32	.11
429-015	1-1/2	2-5/8	2-7/32	1/16	.13
429-020	2	2-7/8	2-3/4	3/32	.21
429-025	2-1/2	3-3/4	3-5/16	3/16	.41
429-030	3	3-31/32	4	3/16	.57
429-040	4	4-1/4	5-1/32	3/16	.85
429-045F	4-1/2	6-7/8	5-7/16	1-7/8	1.43
429-050	5	6-3/16	6-1/8	3/16	1.67
429-060	6	6-5/16	7-1/4	1/4	2.11
429-080	8	8-11/32	9-11/32	1/4	4.22
429-100	10	10-3/8	11-9/16	15/32	7.24
429-100F	10	12-3/8	11-1/2	1-7/8	8.16
429-120	12	12-3/8	13-21/32	3/8	11.68
429-120F	12	14-3/4	13-9/16	2-1/4	13.25
429-140	14	14-13/32	15-5/8	7/16	27.27
429-140F	14	16-1/4	14-7/8	2-1/4	18.22
429-160F	16	18-5/8	17	2-5/8	23.23
429-180F	18	21-3/4	19-1/8	3-3/4	38.65
429-200F	20	24	21-3/16	4	48.63
429-240F	24	29-1/4	25-3/8	5-1/4	82.20

# PVC WHITE SCHEDULE 40 FITTINGS UNIONS & SADDLES



## DEEP SOCKET COUPLING

Socket x Socket

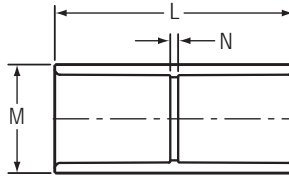

Part Number	Size	L	M	N	Approx. Wt. (Lbs.)
479-005N	1/2	2-1/2	1-1/16	3/16	.04
479-007	3/4	2-7/8	1-5/16	3/32	.07
479-010	1	3-5/8	1-5/8	3/32	.13
479-015	1-1/2	4-5/8	2-1/4	1/8	.24
479-020	2	5-3/32	2-3/4	3/32	.36
479-025	2-1/2	7-1/2	3-5/16	1/4	.79
479-030	3	8	4	1/4	1.06
479-040	4	8-3/16	5	5/16	1.53
479-045F	4-1/2	9-1/2	5-7/16	1-1/2	1.92
479-060F	6	12	7-3/16	1-1/2	3.72

## REDUCER COUPLING

Socket x Socket

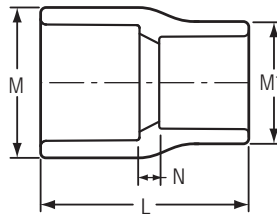

Part Number	Size	L	M	M1	N	Approx. Wt. (Lbs.)
429-101	3/4x1/2	1-25/32	1-5/16	1-3/32	1/8	.04
429-130	1x1/2	2-7/32	1-5/8	1-3/32	13/32	.07
429-131	1x3/4	2-1/8	1-5/8	1-5/16	1/8	.07
429-166	1-1/4x1/2	2-9/16	2-3/32	1-5/32	7/16	.13
429-168	1-1/4x1	2-11/16	2-1/8	1-3/4	5/16	.17
429-210	1-1/2x3/4	2-13/16	2-11/32	1-13/32	7/16	.19
429-211	1-1/2x1	2-23/32	2-7/32	1-5/8	3/8	.13
429-212	1-1/2x1-1/4	2-13/16	2-13/32	2-1/8	5/32	.22
429-247	2x1/2	3-3/32	2-7/8	1-5/32	11/16	.30
429-248	2x3/4	3-7/32	2-7/8	1-13/32	23/32	.30
429-249	2x1	3-1/2	2-13/16	2-5/16	3/4	.41
429-250 <sup>1</sup>	2x1-1/4	3-1/16	2-23/32	2-1/4	13/32	.25
429-251	2x1-1/2	2-13/16	2-27/32	2-1/4	1/8	.19
429-291	2-1/2x1-1/2	3-3/4	3-1/2	2-3/8	19/32	.52
429-292	2-1/2x2	3-5/8	3-15/32	2-7/8	7/16	.48
429-335 <sup>1</sup>	3x1	4-3/16	4-5/32	2-7/8	1-1/4	.91
429-337 <sup>1</sup>	3x1-1/2	4-3/16	4-5/32	2-29/32	1	.87

<sup>1</sup> Outlet sized with bushing



# PVC WHITE SCHEDULE 40 FITTINGS UNIONS & SADDLES

## REDUCER COUPLING (continued)

Socket x Socket

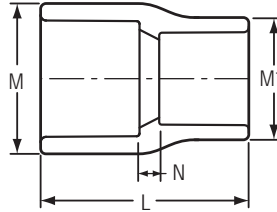

Part Number	Size	L	M	M1	N	Approx. Wt. (Lbs.)
429-338	3x2	4	4-3/16	2-7/8	21/32	.73
429-339 <sup>1</sup>	3x2-1/2	4-5/16	4	4	21/32	.95
429-340F	3x2-1/2	5-5/8	3-7/8	3-1/4	1-3/8	.68
429-416 <sup>1</sup>	4x3/4	5-7/32	5-1/32	2-25/32	2-3/16	1.04
429-417	4x1	5-1/4	5-1/32	2-25/32	2-5/32	1.04
429-420	4x2	5	5-1/32	2-23/32	1-9/16	.83
429-421	4x2-1/2	5	5-1/4	4-1/8	3/4	1.63
429-422	4x3	4-5/8	5-1/4	4-5/32	15/32	1.25
429-422F	4x3	6-1/2	4-15/16	3-15/16	2	1.04
429-460F	4-1/2x4	6-11/16	5-7/16	5	1-15/16	1.39
429-488F	5x3	8	6-1/16	5-1/4	3-1/8	2.29
429-490F	5x4	7-11/16	6-1/16	5	2-7/16	1.60
429-491F	5x4-1/2	7-7/16	6-1/16	5-7/16	1-15/16	1.59
429-528F	6x2	9-1/4	7-1/8	5-1/16	4-5/8	2.75
429-530F	6x3	9-3/16	7-1/8	5-1/4	4-1/16	2.89
429-532	6x4	6-15/32	7-1/4	5-1/32	1-11/32	2.05
429-532F	6x4	8-7/8	7-1/8	5	3-3/8	1.80
429-533F	6x5	8-5/8	7-1/8	6-1/16	2-3/8	2.50
429-534F	6x4-1/2	8-11/16	7-1/8	5-7/16	2-15/16	2.05
429-578F	8x2	14-7/8	9-3/16	5	9-1/4	5.75
429-580F	8x3	14-13/16	9-3/16	5	8-11/16	5.71
429-582	8x4	8-7/16	9-11/32	5-1/16	2-11/32	4.02
429-582F	8x4	14-1/2	9-3/16	5	8	5.11
429-583F	8x5	14-1/4	9-3/16	6-1/16	7	5.07
429-585	8x6	8-13/32	9-11/32	7-9/32	1-11/32	4.07
429-585F	8x6	11	9-3/16	7-3/16	3-1/2	4.63
429-621F	10x2	17-5/8	11-3/8	5	11	8.15
429-623F	10x3	17-9/16	11-3/8	5	10-7/16	7.97
429-624	10x4	10-7/16	11-17/32	5-1/16	3-11/32	7.40
429-624F	10x4	17-1/4	11-3/8	5	9-3/4	7.18
429-625F	10x5	17	11-3/8	6-1/16	8-3/4	7.31
429-626	10x6	10-7/16	11-9/16	7-9/32	2-1/4	7.11
429-626F	10x6	13-7/8	11-3/8	7-1/4	5-3/8	6.61
429-628	10x8	10-7/16	11-5/8	9-3/8	1-3/8	7.07
429-628F	10x8	13-1/4	11-9/16	9-7/16	3-3/4	8.95
429-661F	12x2	24-3/8	13-9/16	5	16-3/4	19.16
429-663F	12x3	24-5/16	13-9/16	5	16-3/16	14.92
429-664F	12x4	24	13-9/16	5	15-1/2	15.20
429-665F	12x5	23-3/4	13-9/16	6-1/16	14-1/2	21.03

<sup>1</sup> Outlet sized with bushing

# PVC WHITE SCHEDULE 40 FITTINGS UNIONS & SADDLES



## REDUCER COUPLING (continued)

Socket x Socket

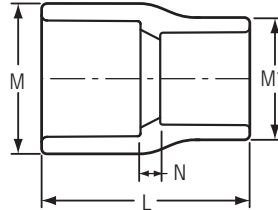

Part Number	Size	L	M	M1	N	Approx. Wt. (Lbs.)
429-666	12x6	12-13/32	13-21/32	7-9/32	3-9/32	10.73
429-666F	12x6	20-1/2	13-9/16	7-1/4	11	14.23
429-668	12x8	12-13/32	13-21/32	9-3/8	2-1/4	10.58
429-668F	12x8	15-3/4	13-9/16	9-7/16	5-1/4	12.31
429-670	12x10	12-3/8	13-21/32	11-19/32	1-9/32	10.84
429-670F	12x10	15-1/8	13-9/16	11-9/16	3-5/8	13.16
429-693F	14x3	26-3/16	14-13/16	5	17-5/16	39.67
429-694F	14x4	25-7/8	14-13/16	5	16-5/8	20.57
429-696F	14x6	22-3/8	14-13/16	7-1/4	12-1/8	20.57
429-698F	14x8	21-13/16	14-3/4	9-1/4	10-9/16	18.37
429-700F	14x10	17	14-13/16	11-9/16	4-3/4	15.36
429-702F	14x12	16-1/2	15	13-3/4	3-1/4	19.59
429-751F	16x2	32-7/8	17	5	23-1/2	33.96
429-754F	16x4	32-1/2	17	5	22-1/4	33.96
429-756F	16x6	29	17	7-3/16	17-3/4	33.53
429-758F	16x8	24-3/4	17	9-7/16	12-1/2	33.90
429-760F	16x10	24	17	11-9/16	10-3/4	35.66
429-762F	16x12	18-7/8	17	13-3/4	4-5/8	22.40
429-764F	16x14	18-1/2	16-7/8	14-7/8	3-1/2	21.66
429-786F	18x6	38	19	7-3/16	25-3/4	60.39
429-788F	18x8	33-3/4	19	9-7/16	20-1/2	43.61
429-790F	18x10	33	19	11-9/16	18-3/4	46.43
429-792F	18x12	27-7/8	19	13-5/8	12-5/8	44.78
429-794F	18x14	27-1/2	19	14-7/8	11-1/2	43.23
429-796F	18x16	21-5/8	19	17	4-5/8	30.98
429-814F	20x4	50-1/2	21-1/8	5	38-1/4	---
429-816F	20x6	47	21-1/8	7-3/16	33-3/4	74.45
429-818F	20x8	42-3/4	21-1/8	9-7/16	28-1/2	97.93
429-820F	20x10	42	21-1/8	11-9/16	26-3/4	82.76
429-822F	20x12	36-7/8	21-1/8	13-3/4	20-5/8	74.24
429-824F	20x14	36-1/2	21-3/8	14-7/8	19-1/2	71.00
429-826F	20x16	30-5/8	21-1/8	17	12-5/8	58.53
429-828F	20x18	23-1/4	21-1/8	19-1/8	4-1/4	45.38
429-906F	24x6	59-1/4	25-3/16	7-3/16	44	120.00
429-908F	24x8	55	25-3/16	9-7/16	38-3/4	124.96
429-910F	24x10	54-1/4	25-3/16	11-9/16	37	126.88
429-912F	24x12	49-1/8	25-3/16	13-3/4	30-7/8	120.00
429-914F	24x14	48-3/4	25-3/16	14-7/8	29-3/4	111.51
429-916F	24x16	42-7/8	25-3/16	17	22-7/8	107.16



# PVC WHITE SCHEDULE 40 FITTINGS UNIONS & SADDLES

## REDUCER COUPLING (continued)

Socket x Socket

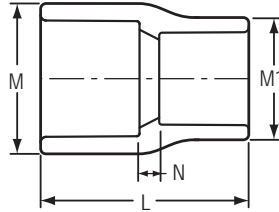

Part Number	Size	L	M	M1	N	Approx. Wt. (Lbs.)
429-918F	24x18	35-1/2	25-3/16	19-1/8	14-1/2	84.69
429-920F	24x20	28-3/4	25-3/16	21-3/16	6-3/4	61.04

## ECCENTRIC REDUCER COUPLING

Socket x Socket

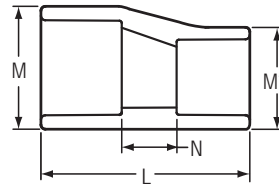

Part Number	Size	L	M	M1	N	Approx. Wt. (Lbs.)
429-168FE	1-1/4x1	4-7/8	1-15/16	1-9/16	2-1/8	.28
429-212FE	1-1/2x1-1/4	4-5/8	2-3/16	1-15/16	1-5/8	.24
429-250FE	2x1-1/4	5-3/4	2-5/8	1-15/16	2-1/2	.26
429-251FE	2x1-1/2	5-1/2	2-11/16	2-3/16	2-1/4	.29
429-290FE	2-1/2x1-1/4	9-5/8	3-3/16	1-15/16	6-1/8	.81
429-291FE	2-1/2x1-1/2	9-3/8	3-3/16	2-3/16	5-7/8	.79
429-292FE	2-1/2x2	6-3/8	3-3/16	2-11/16	2-5/8	.44
429-336FE	3x1-1/4	11-1/8	3-13/16	1-15/16	7-3/8	.85
429-337FE	3x1-1/2	10-7/8	3-13/16	2-3/16	7-1/8	.77
429-338E	3x2	5-7/8	4-5/32	2-7/8	2-15/32	1.01
429-338FE	3x2	7-15/16	3-13/16	2-11/16	3-15/16	.63
429-339FE	3x2-1/2	6-3/4	3-7/8	3-1/4	2-1/2	.79
429-418FE	4x1-1/4	16-1/8	4-15/16	1-15/16	12-3/8	1.96
429-419FE	4x1-1/2	15-7/8	4-15/16	2-3/16	12-1/8	1.72
429-420E	4x2	7-15/32	5	2-23/32	4-1/16	1.24
429-420FE	4x2	12-13/16	4-15/16	2-11/16	8-13/16	1.65
429-421FE	4x2-1/2	11-3/4	4-15/16	3-1/4	7-1/2	1.78
429-422FE	4x3	8-5/8	4-15/16	3-15/16	4-1/8	1.28
429-490FE	5x4	9-7/16	6-1/16	5	4-3/16	5.95
429-527FE	6x1-1/2	23-9/16	7-1/8	2-3/16	18-13/16	6.23
429-528FE	6x2	15-7/8	7-1/8	2-11/16	11-1/4	4.41
429-529FE	6x2-1/2	19-7/16	7-1/8	3-1/4	14-3/16	3.77
429-530FE	6x3	16-5/16	7-1/8	3-15/16	10-13/16	3.92
429-532E	6x4	8-31/32	7-9/32	5-1/32	3-15/16	2.90



# PVC WHITE SCHEDULE 40 FITTINGS UNIONS & SADDLES



## ECCENTRIC REDUCER COUPLING (continued)

Socket x Socket

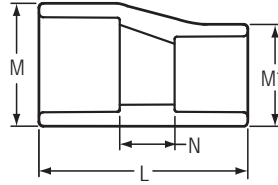

Part Number	Size	L	M	M1	N	Approx. Wt. (Lbs.)
429-532FE	6x4	11-1/8	7-1/8	5	5-5/8	2.27
429-533FE	6x5	10-5/8	7-1/8	6-1/16	4-3/8	2.84
429-578FE	8x2	27-1/8	9-3/16	2-11/16	21-1/2	8.22
429-580FE	8x3	25-5/16	9-3/16	3-15/16	18-13/16	7.20
429-582FE	8x4	19-5/8	9-3/16	5	13-3/8	8.22
429-583FE	8x5	15-5/8	9-3/16	6-1/16	12-3/8	6.81
429-585FE	8x6	14-3/8	9-3/16	7-3/16	6-7/8	5.53
429-624FE	10x4	22-3/8	11-3/8	5	15-1/8	12.85
429-625FE	10x5	22-3/8	11-3/8	6-1/16	14-1/8	10.65
429-626FE	10x6	17-1/8	11-3/8	7-1/4	8-5/8	7.49
429-628FE	10x8	16-5/16	11-3/8	9-1/4	6-13/16	9.69
429-664FE	12x4	32-3/8	13-1/2	5	24-1/8	20.84
429-665FE	12x5	32-3/8	13-1/2	6-1/16	23-1/8	20.37
429-666FE	12x6	27-1/8	13-1/2	7-1/4	17-5/8	16.81
429-668FE	12x8	26-5/16	13-1/2	9-1/4	15-3/16	23.88
429-670FE	12x10	18-3/8	13-1/2	11-1/2	6-7/8	15.07
429-696FE	14x6	31-3/8	15	7-1/4	21-1/8	26.82
429-698FE	14x8	30-9/16	15	9-1/4	19-5/16	26.76
429-700FE	14x10	22-3/4	15	11-3/4	10-1/2	23.23
429-702FE	14x12	19	15	13-3/4	5-3/4	25.66
429-756FE	16x6	43-5/8	17	7-1/4	32-3/8	49.49
429-758FE	16x8	42-13/16	17	9-1/4	30-9/16	47.87
429-760FE	16x10	34-7/8	17	11-1/2	21-5/8	39.76
429-762FE	16x12	26-1/2	17	13-3/4	12-1/4	34.02
429-764FE	16x14	19	16-7/8	14-7/8	6-3/4	24.61
429-786FE	18x6	56	19	7-1/4	43-3/4	71.11
429-788FE	18x8	55-3/16	19	9-1/4	41-15/16	70.93
429-790FE	18x10	47-1/4	19	11-1/2	33	65.32
429-792FE	18x12	38-7/8	19	13-3/4	23-5/8	62.16
429-794FE	18x14	34-1/8	19	14-7/8	18-1/8	54.24
429-796FE	18x16	25	19	17	8	38.72



# PVC WHITE SCHEDULE 40 FITTINGS UNIONS & SADDLES

## FABRICATED REPAIR COUPLING

Gasket x Gasket

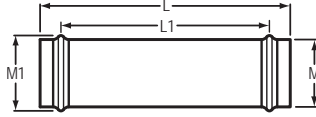

Part Number	Size	L	L1	M	M1	Approx. Wt. (Lbs.)
428-020F	2	9-1/8	6	2-11/16	3-1/16	.59
428-030F	3	15-1/2	11	3-15/16	4-9/16	1.99
428-040F	4	19-1/2	16-1/4	5	5-3/4	4.18
428-060F	6	23-1/2	19-3/4	7-3/8	7-3/4	8.33
428-080F	8	26-1/8	21-1/4	9-3/8	10-1/8	14.01
428-100F	10	27-1/4	22-3/8	11-5/8	12-3/8	20.95
428-120F	12	28-3/8	22-3/8	13-3/4	14-11/16	28.49
428-140F	14	18-3/8	12	14-7/8	16-1/4	24.45
428-160F	16	21	14-3/4	17	18-1/2	36.03

## COUPLING

Fipt x Fipt

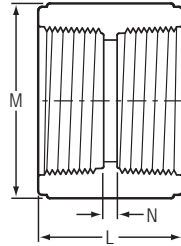

Part Number	Size	L	M	N	Approx. Wt. (Lbs.)
430-005	1/2	1-9/16	1-1/8	7/32	.04
430-007	3/4	1-9/16	1-11/32	3/32	.05
430-010	1	2-1/16	1-11/16	3/32	.09
430-012	1-1/4	2-3/16	2-3/16	3/16	.21



**SPECIAL REINFORCED COUPLING**

SR Fipt x SR Fipt

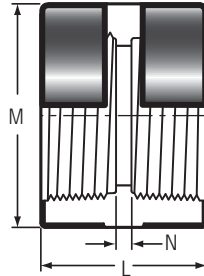

Part Number	Size	L	M	N	Approx. Wt. (Lbs.)
430-005SR	1/2	1-9/16	1-3/16	1/16	.07
430-007SR	3/4	1-29/32	1-3/8	3/32	.08
430-010SR	1	1-15/16	1-23/32	1/16	.13
430-012SR	1-1/4	2-1/16	2-1/16	3/16	.19
430-015SR	1-1/2	2-3/16	2-7/16	1/4	.29
430-020SR	2	2-1/4	3	1/4	.42

**REDUCER COUPLING**

Fipt x Fipt

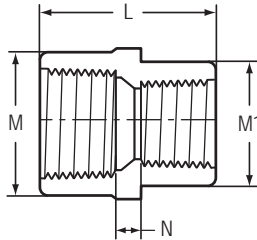

Part Number	Size	L	M	M1	N	Approx. Wt. (Lbs.)
430-101	3/4x1/2	1-11/16	1-3/8	1-3/16	1/4	.06

**SPECIAL REINFORCED REDUCER COUPLING**

SR Fipt x SR Fipt

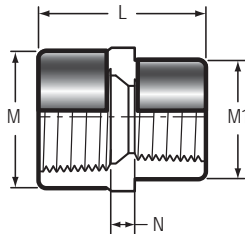

Part Number	Size	L	M	M1	N	Approx. Wt. (Lbs.)
430-101SR	3/4x1/2	1-3/4	1-3/8	1-7/32	1/4	.08



# PVC WHITE SCHEDULE 40 FITTINGS UNIONS & SADDLES

## IPS TO PIP ADAPTER

Spigot x Socket

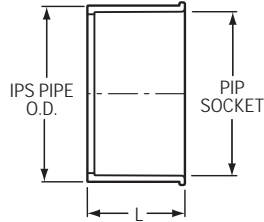

Part Number	Size	L	Approx. Wt. (Lbs.)
431-060	6	3-9/16	.91
431-080	8	4-21/32	1.43
431-100F	10	5-5/8	2.71
431-120F	12	6-3/4	3.61

## RISER EXTENSION

Fipt x Mipt

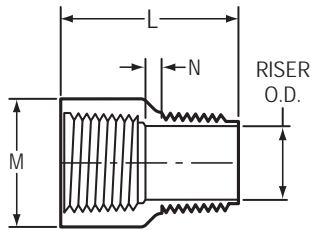

Part Number	Size	L	M	N	Approx. Wt. (Lbs.)
434-005	1/2	1-1/2	1-1/8	1/8	.03
434-007	3/4	1-17/32	1-5/16	5/32	.04
434-010	1	1-29/32	1-5/8	3/16	.07

## FEMALE ADAPTER

Socket x Fipt

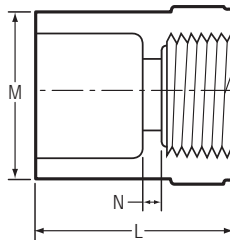

Part Number	Size	L	M	N	Approx. Wt. (Lbs.)
435-003	3/8	1-7/16	1	3/32	.03
435-005	1/2	1-19/32	1-3/32	3/32	.04
D435-005	1/2	2-1/8	1-1/8	1/8	.04
435-007	3/4	1-27/32	1-5/16	3/32	.05

# PVC WHITE SCHEDULE 40 FITTINGS UNIONS & SADDLES



## FEMALE ADAPTER

Socket x Fipt

(continued)

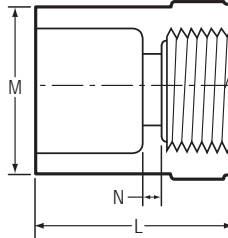

Part Number	Size	L	M	N	Approx. Wt. (Lbs.)
D435-007	3/4	2-7/32	1-5/16	3/32	.06
435-010	1	2	1-21/32	3/32	.08
435-012	1-1/4	2-9/32	1-31/32	1/16	.11
435-015	1-1/2	2-5/16	2-7/32	3/32	.14
435-020	2	2-1/2	2-3/4	1/8	.19
435-025	2-1/2	3-1/4	3-5/16	3/16	.41
435-030	3	3-1/2	4	1/4	.56
435-040	4	3-23/32	5-1/32	3/16	.83
435-050	5	5-1/16	6-5/16	3/16	1.47
435-060	6	5-3/4	7-3/16	5/16	2.07
435-080	8	6-15/16	9-3/8	1/4	3.88
435-100F	10	10-1/4	11-15/16	3	10.88
435-120F	12	11-1/8	14-1/8	2-5/8	16.56

## SPECIAL REINFORCED FEMALE ADAPTER

Socket x SR Fipt

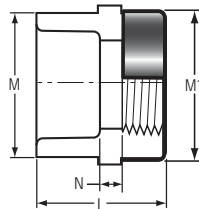

Part Number	Size	L	M	M1	N	Approx. Wt. (Lbs.)
435-002SR	1/4	1-5/16	13/16	13/16	5/32	.03
435-003SR	3/8	1-7/16	15/16	15/16	1/16	.04
435-005SR	1/2	1-3/4	1-3/16	1-3/16	3/16	.06
435-007SR	3/4	1-7/8	1-13/32	1-3/8	3/32	.08
435-010SR	1	2-1/8	1-3/4	1-3/4	1/8	.13
435-012SR	1-1/4	2-5/16	2-3/32	2-3/32	1/8	.19
435-015SR	1-1/2	2-7/16	2-7/16	2-7/16	1/8	.27
435-020SR	2	2-11/16	3	3	1/4	.43
435-025SR	2-1/2	3-1/4	3-9/16	3-9/16	1/4	.68
435-030SR	3	3-1/2	4-9/32	4-5/16	5/16	.95
435-040SR	4	3-15/16	5-7/32	5-7/32	3/16	1.37



# PVC WHITE SCHEDULE 40 FITTINGS UNIONS & SADDLES

## REDUCING FEMALE ADAPTER

Socket x Fipt

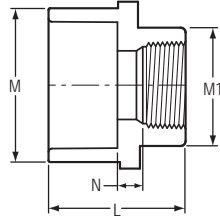

Part Number	Size	L	M	M1	N	Approx. Wt. (Lbs.)
435-072	1/2x1/4	1-19/32	1-3/32	13/16	1/4	.03
435-073	1/2x3/8	1-17/32	1-3/32	15/16	3/16	.03
435-074	1/2x3/4	1-19/32	1-3/32	1-5/16	3/16	.05
435-101	3/4x1/2	1-13/16	1-5/16	1-1/8	3/32	.05
435-102	3/4x1	1-15/16	1-5/8	1-5/16	3/32	.07
435-130	1x1/2	1-27/32	1-5/8	1-1/8	3/32	.07
435-131	1x3/4	2-1/8	1-5/8	1-5/16	3/8	.07
435-133	1x1-1/2	2-3/8	1-5/8	2-7/32	1/4	.13
435-168	1-1/4x1	2-1/2	1-31/32	1-5/8	11/32	.12
435-247	2x1/2	2-25/32	2-23/32	1-3/16	21/32	.19
435-460F	4-1/2x4	8-1/4	5-5/8	5	3-7/8	1.92
435-578F	8x2	14-7/8	8-5/8	5-1/16	9-5/8	5.75
435-582F	8x4	15-3/16	9-1/4	5	9-7/16	5.99
435-628F	8x10	11	11-3/4	9-1/4	4-1/16	6.60

## SPECIAL REINFORCED REDUCING FEMALE ADAPTER

Socket x SR Fipt

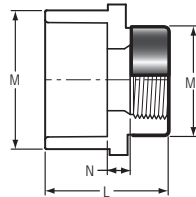

Part Number	Size	L	M	M1	N	Approx. Wt. (Lbs.)
435-072SR	1/2x1/4	1-5/8	1-3/32	27/32	1/4	.04
435-073SR	1/2x3/8	1-17/32	1-3/32	31/32	3/16	.04
435-074SR	1/2x1/4	1-3/4	1-3/16	1-3/8	1/8	.07
435-101SR	3/4x1/2	1-7/8	1-3/8	1-3/16	1/4	.07
435-102SR	3/4x1	2-1/16	1-13/32	1-23/32	1/4	.12
435-130SR	1x1/2	2	1-11/16	1-3/16	5/32	.10
435-131SR	1x3/4	2-1/16	1-3/4	1-3/8	7/32	.12
435-247SR	2x1/2	2-13/16	2-23/32	1-3/16	21/32	.20



**SPIGOT FEMALE ADAPTER**

Spigot x Fipt

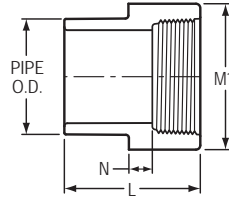

Part Number	Size	L	M1	N	Approx. Wt. (Lbs.)
478-005	1/2	1-19/32	1-3/32	3/16	.03
478-007	3/4	1-15/16	1-3/8	5/32	.06
478-010	1	2-7/16	1-23/32	5/32	.10
478-012	1-1/4	2-9/16	2-1/16	9/32	.14
478-015	1-1/2	2-5/8	2-5/16	7/32	.17
478-020	2	2-3/4	2-27/32	3/16	.27
478-030	3	3-7/8	4	9/32	.57
478-040	4	4	5	3/8	.83

**SPECIAL REINFORCED SPIGOT FEMALE ADAPTER**

Spigot x SR Fipt

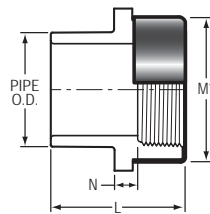

Part Number	Size	L	M1	N	Approx. Wt. (Lbs.)
478-005SR	1/2	1-3/4	1-3/16	5/32	.05
478-007SR	3/4	1-15/16	1-3/8	11/32	.07
478-010SR	1	2-1/4	1-23/32	5/16	.12
478-012SR	1-1/4	2-7/16	2-1/16	3/8	.18
478-015SR	1-1/2	2-5/8	2-13/32	13/32	.25
478-020SR	2	2-13/16	3	3/8	.39
478-030SR	3	3-13/16	4-1/4	15/32	.91
478-040SR	4	4-3/8	5-7/32	9/16	1.44



# PVC WHITE SCHEDULE 40 FITTINGS UNIONS & SADDLES

## SPECIAL REINFORCED SPIGOT REDUCING FEMALE ADAPTER

Spigot x SR Fipt

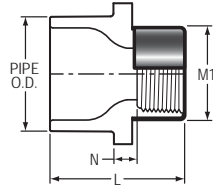

Part Number	Size	L	M1	N	Approx. Wt. (Lbs.)
478-072SR	1/2x1/4	1-3/8	27/32	3/16	.03
478-098SR	3/4x1/4	2-1/16	27/32	1/2	.05
478-128SR	1x1/4	2-3/8	27/32	11/16	.08

## MALE ADAPTER

Mipt x Socket

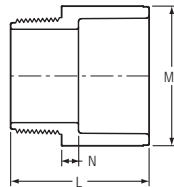

Part Number	Size	L	M1	N	Approx. Wt. (Lbs.)
436-003	3/8	1-3/8	7/8	7/32	.02
436-005	1/2	1-17/32	1-1/8	5/32	.03
436-007	3/4	1-23/32	1-5/16	5/32	.04
436-010	1	2-1/16	1-5/8	5/32	.07
436-012	1-1/4	2-7/16	1-31/32	3/16	.11
436-015	1-1/2	2-17/32	2-1/4	3/16	.15
436-020	2	2-21/32	2-3/4	7/32	.20
436-025	2-1/2	3-13/16	3-13/32	9/32	.43
436-030	3	3-29/32	4-3/32	9/32	.57
436-040	4	4-1/32	5-1/8	9/32	.82
436-050	5	5-5/32	6-1/4	5/16	1.42
436-060	6	5-11/16	7-9/32	11/16	2.36
436-080	8	6-15/16	9-3/8	13/32	4.04
436-100F	10	10-3/8	11-15/16	3-3/16	11.17
436-120F	12	11-1/8	14-1/8	2-3/4	16.44



# PVC WHITE SCHEDULE 40 FITTINGS UNIONS & SADDLES



## REDUCING MALE ADAPTER

Mipt x Socket

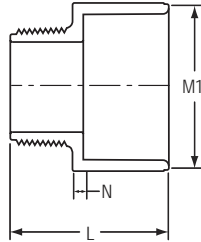

Part Number	Size	L	M1	N	Approx. Wt. (Lbs.)
436-053	3/8x1/2	1-11/16	1-3/16	1/4	.04
436-073	1/2x3/8	1-17/32	15/16	1/8	.02
436-074	1/2x3/4	1-25/32	1-5/16	5/32	.04
436-075	1/2x1	2-9/32	1-5/8	17/32	.07
436-101	3/4x1/2	1-17/32	1-1/8	3/32	.03
436-102	3/4x1	1-15/16	1-21/32	3/16	.07
436-131	1x3/4	1-29/32	1-3/16	3/16	.05
436-132	1x1-1/4	2-1/4	1-31/32	7/32	.10
436-133	1x1-1/2	2-3/8	2-1/4	1/4	.12
436-168	1-1/4x1	2-1/4	1-5/8	3/16	.09
436-169	1-1/4x1-1/2	2-17/32	2-7/32	3/16	.14
436-212	1-1/2x1-1/4	2-15/32	2	7/32	.12
436-213	1-1/2x2	2-5/8	2-3/4	15/32	.22
436-251	2x1-1/2	2-9/16	2-7/32	3/16	.18
436-252	2x2-1/2	3-3/32	3-5/16	1/4	.36
436-253	2x3	3-13/16	4	1	.52
436-294	2-1/2x3	4-3/32	4-1/32	5/8	.57
436-296	2-1/2x4	3-29/32	5-3/16	5/16	.80
436-342	3x4	4-5/8	5-1/16	7/8	.97
436-537F	6x10	15-1/2	11-3/8	7-15/16	8.50



# PVC WHITE SCHEDULE 40 FITTINGS UNIONS & SADDLES

## MALE ADAPTER

Spigot x Mipt

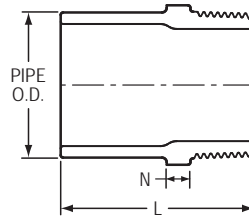

Part Number	Size	L	N	Approx. Wt. (Lbs.)
461-005	1/2	1-11/16	11/32	.03
461-007	3/4	2	13/32	.04
461-010	1	2-1/4	11/32	.06
461-131	1x3/4	1-15/16	1/4	.06
461-012	1-1/4	2-9/32	9/32	.09
461-015	1-1/2	2-7/16	5/16	.12
461-020	2	2-9/16	3/8	.17

## REDUCER BUSHING (Flush Style)

Spigot x Socket

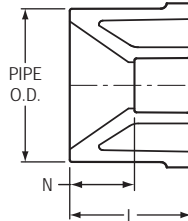

Part Number	Size	L	N	Approx. Wt. (Lbs.)
437-052	3/8x1/4	31/32	5/16	.01
437-072	1/2x1/4	1-3/32	13/32	.02
437-073	1/2x3/8	7/8	3/8	.02
437-101	3/4x1/2	1-1/16	9/32	.02
437-130	1x1/2	1-1/4	15/32	.05
437-131	1x3/4	1-1/4	5/16	.03
437-166	1-1/4x1/2	1-13/32	21/32	.08
437-167	1-1/4x3/4	1-1/2	19/32	.09
437-168	1-1/4x1	1-1/2	7/16	.06
437-209	1-1/2x1/2	1-15/32	23/32	.11
437-210	1-1/2x3/4	1-7/16	7/16	.12
437-211	1-1/2x1	1-17/32	1/2	.12
437-212	1-1/2x1-1/4	1-17/32	9/32	.06
437-247	2x1/2	1-5/8	7/8	.17
437-248	2x3/4	1-9/16	9/16	.16
437-249	2x1	1-9/16	17/32	.17
437-250	2x1-1/4	1-19/32	11/32	.18
437-251	2x1-1/2	1-9/16	1/4	.13
437-287	2-1/2x1/2	2-5/16	1-1/2	.32



**REDUCER BUSHING (Flush Style) (continued)**

Spigot x Socket

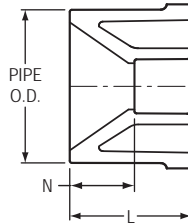

Part Number	Size	L	N	Approx. Wt. (Lbs.)
437-288	2-1/2x3/4	2-3/8	1-3/8	.33
437-289	2-1/2x1	2-1/32	29/32	.37
437-290	2-1/2x1-1/4	2-3/16	1-1/8	.37
437-291	2-1/2x1-1/2	2-5/32	1-3/16	.34
437-292	2-1/2x2	2-1/16	11/16	.23
437-333 <sup>1</sup>	3x1/2	2-13/32	1-5/8	.53
437-334	3x3/4	2-5/16	1-5/16	.49
437-335	3x1	2-7/32	1-1/4	.48
437-336	3x1-1/4	2-9/32	1-1/32	.49
437-337	3x1-1/2	2-9/32	31/32	.48
437-338	3x2	2-7/32	9/16	.47
437-339	3x2-1/2	2-7/32	7/16	.37
437-417 <sup>1</sup>	4x1	2-19/32	1-9/16	1.03
437-418 <sup>1</sup>	4x1-1/4	2-19/32	1-7/16	1.04
437-419 <sup>1</sup>	4x1-1/2	2-19/32	1-1/4	.99
437-420	4x2	2-13/32	1-1/32	.86
437-421	4x2-1/2	2-5/16	9/16	.75
437-422	4x3	2-11/32	15/32	.78
437-486	5x2	3-13/32	2-1/32	1.54
437-488	5x3	3-7/16	1-15/32	1.40
437-490	5x4	2-31/32	23/32	1.31
437-528	6x2	3-17/32	2-5/32	2.15
437-530	6x3	3-17/32	1-5/8	2.21
437-532	6x4	3-9/16	1-1/2	2.12
437-534	6x5	3-17/32	7/8	1.93
437-578 <sup>1</sup>	8x2	5	3-5/8	4.92
437-580	8x3	5-1/4	3-1/4	4.92
437-582	8x4	4-17/32	2-1/2	3.96
437-583 <sup>1</sup>	8x5	4-3/4	1-3/4	5.61
437-585	8x6	4-13/32	1-3/8	4.04
437-621 <sup>1</sup>	10x2	6	4	9.88
437-623 <sup>1</sup>	10x3	6	3-17/32	9.32
437-624	10x4	6	3-3/4	9.57
437-626	10x6	5-1/2	2-3/8	5.77
437-628	10x8	5-5/16	1-5/16	6.88
437-666 <sup>1</sup>	12x6	6-11/16	3-3/4	13.96
437-666F	12x6	6-7/16	3-3/8	18.74

<sup>1</sup>Outlet sized with bushing



# PVC WHITE SCHEDULE 40 FITTINGS UNIONS & SADDLES

## REDUCER BUSHING (Flush Style) (continued)

Spigot x Socket

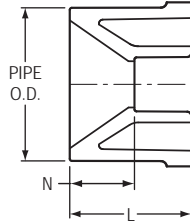

Part Number	Size	L	N	Approx. Wt. (Lbs.)
437-668	12x8	6-1/2	2-7/16	9.60
437-670	12x10	6-1/2	1-1/2	12.67
437-670F	12x10	6	1	11.32
437-696F	14x6	7-11/16	4-11/16	23.05
437-698F	14x8	7-5/16	3-5/16	19.00
437-700F	14x10	7-1/2	2-1/2	22.00
437-702F	14x12	7	1	9.18
437-756F	16x6	8-11/16	5-11/16	42.60
437-758F	16x8	8-5/16	4-5/16	37.86
437-760F	16x10	8-1/2	3-1/2	40.97
437-762F	16x12	8	2	27.95
437-764F	16x14	8	1	18.68
437-786F	18x6	9-11/16	6-11/16	66.03
437-788F	18x8	9-5/16	5-5/16	59.63
437-790F	18x10	9-1/2	4-1/2	64.56
437-792F	18x12	9	3	52.44
437-794F	18x14	9	2	43.08
437-796F	18x16	9	1	20.03
437-816F	20x6	10-11/16	7-11/16	122.62
437-818F	20x8	10-5/16	6-5/16	112.44
437-820F	20x10	10-1/2	5-1/2	95.06
437-822F	20x12	10	4	82.84
437-824F	20x14	10	3	73.74
437-826F	20x16	10	2	54.05
437-828F	20x18	10	1	30.35
437-906F	24x6	12-11/16	9-11/16	208.00
437-908F	24x8	12-5/16	8-5/16	172.22
437-910F	24x10	12-1/2	7-1/2	177.27
437-912F	24x12	12	6	164.19
437-914F	24x14	12	5	153.83
437-916F	24x16	12	4	136.15
437-918F	24x18	13	3	109.14
437-920F	24x20	12	2	80.40

# PVC WHITE SCHEDULE 40 FITTINGS UNIONS & SADDLES



## REDUCER BUSHING (Flush Style)

Spigot x Fipt

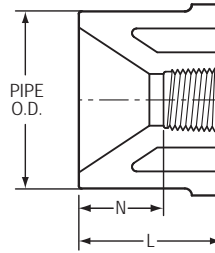

Part Number	Size	L	N	Approx. Wt. (Lbs.)
438-052	3/8x1/4	31/32	3/8	.01
438-071	1/2x1/8	1	9/16	.02
438-072	1/2x1/4	1-1/32	7/16	.02
438-073	1/2x3/8	1	7/16	.02
438-098	3/4x1/4	1-7/32	5/8	.04
438-101	3/4x1/2	1-1/4	1/2	.03
438-127	1x1/8	1-3/8	13/16	.06
438-128	1x1/4	1-13/32	25/32	.07
438-129	1x3/8	1-13/32	19/32	.07
438-130	1x1/2	1-3/8	21/32	.05
438-131	1x3/4	1-1/16	3/8	.04
438-166	1-1/4x1/2	1-15/32	23/32	.10
438-167	1-1/4x3/4	1-15/32	23/32	.09
438-168	1-1/4x1	1-7/16	1/2	.07
438-206	1-1/2x1/8	1-11/16	1-1/4	.14
438-207	1-1/2x1/4	1-19/32	15/16	.11
438-209	1-1/2x1/2	1-11/16	1	.16
438-210	1-1/2x3/4	1-9/16	27/32	.13
438-211	1-1/2x1	1-23/32	13/16	.15
438-212	1-1/2x1-1/4	1-9/16	11/16	.07
438-245	2x1/4	1-3/4	1-5/32	.18
438-247	2x1/2	1-29/32	1-5/32	.26
438-248	2x3/4	1-7/8	1-5/32	.26
438-249	2x1	1-7/8	1	.26
438-250	2x1-1/4	1-5/8	13/16	.18
438-251	2x1-1/2	1-19/32	5/8	.14
438-287	2-1/2x1/2	2-3/8	1-5/8	.41
438-288	2-1/2x3/4	2-3/8	1-9/16	.44
438-289	2-1/2x1	2-11/32	1-13/32	.44
438-290	2-1/2x1-1/4	2-3/8	1-3/8	.43
438-291	2-1/2x1-1/2	2-3/8	1-3/8	.33
438-292	2-1/2x2	2-1/16	1-1/16	.26
438-334	3x3/4	2-9/32	1-9/16	.58
438-335	3x1	2-1/4	1-11/32	.58
438-336	3x1-1/4	2-1/4	1-5/16	.62
438-337	3x1-1/2	2-1/4	1-1/4	.58
438-338	3x2	2-3/16	1-7/32	.56
438-339	3x2-1/2	2-3/8	3/4	.46



# PVC WHITE SCHEDULE 40 FITTINGS UNIONS & SADDLES

## REDUCER BUSHING (Flush Style)

Spigot x Fipt

(continued)

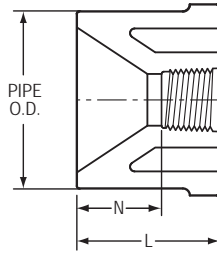

Part Number	Size	L	N	Approx. Wt. (Lbs.)
438-420	4x2	2-13/32	1-13/32	.90
438-421	4x2-1/2	2-21/32	1-3/32	1.09
438-422	4x3	2-13/32	1	.77
438-488	5x3	3-7/16	1-13/16	1.57
438-490	5x4	2-15/16	1-11/32	1.19
438-528	6x2	3-17/32	2-17/32	2.92
438-530	6x3	3-17/32	2-1/8	2.31
438-532	6x4	3-17/32	2-1/32	2.54
438-534	6x5	3-31/32	2-3/16	1.91

## SPECIAL REINFORCED REDUCER BUSHING (Flush Style)

Spigot x SR Fipt

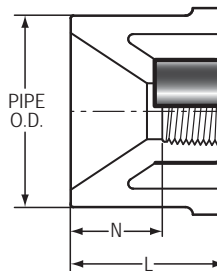

Part Number	Size	L	N	Approx. Wt. (Lbs.)
438-128SR	1x1/4	1-13/32	25/32	.07
438-207SR	1-1/2x1/4	1-19/32	15/16	.13
438-209SR	1-1/2x1/2	1-11/16	15/16	.17
438-210SR	1-1/2x3/4	1-9/16	7/8	.13
438-247SR	2x1/2	1-29/32	1-5/32	.26
438-248SR	2x3/4	1-7/8	1-1/8	.26
438-249SR	2x1	1-29/32	31/32	.27
438-334SR	3x3/4	2-1/4	1-1/2	.58
438-335SR	3x1	2-1/4	1-11/32	.59
438-336SR	3x1-1/4	2-1/4	1-5/16	.59
438-337SR	3x1-1/2	2-1/4	1-3/8	.68
438-420SR	4x2	2-13/32	1-13/32	.85
438-528SR	6x2	3-5/16	2-9/32	2.63
438-530SR	6x3	3-9/32	1-7/8	2.70
438-532SR	6x4	3-1/2	2-1/32	2.60



**REDUCER (T.T.) BUSHING (Flush Style)**

Mipt x Fipt

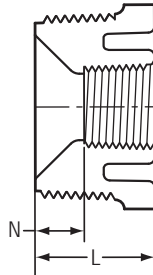

Part Number	Size	L	N	Approx. Wt. (Lbs.)
439-052	3/8x1/4	13/16	1/4	.01
439-071	1/2x1/8	27/32	13/32	.02
439-072	1/2x1/4	29/32	3/8	.02
439-073	1/2x3/8	15/16	3/8	.01
439-098	3/4x1/4	1-1/32	15/32	.03
439-099	3/4x3/8	1-1/32	7/16	.03
439-101	3/4x1/2	15/16	3/16	.02
439-128	1x1/4	1-1/8	17/32	.05
439-130	1x1/2	1-7/32	1/2	.06
439-131	1x3/4	1-1/8	13/32	.03
439-166	1-1/4x1/2	1-5/16	9/16	.09
439-167	1-1/4x3/4	1-9/32	9/16	.08
439-168	1-1/4x1	1-3/16	9/32	.06
439-209	1-1/2x1/2	1-11/32	19/32	.11
439-210	1-1/2x3/4	1-11/32	19/32	.11
439-211	1-1/2x1	1-11/32	7/16	.10
439-212	1-1/2x1-1/4	1-11/32	13/32	.06
439-247	2x1/2	1-3/8	21/32	.16
439-248	2x3/4	1-3/8	5/8	.16
439-249	2x1	1-3/8	15/32	.17
439-250	2x1-1/4	1-3/8	7/16	.16
439-251	2x1-1/2	1-3/8	13/32	.12
439-292	2-1/2x2	1-29/32	7/8	.22
439-337	3x1-1/2	1-15/16	29/32	.50
439-338	3x2	1-15/16	15/16	.45
439-339	3x2-1/2	1-15/16	5/8	.37
439-422	4x3	2-1/8	1/2	.72



# PVC WHITE SCHEDULE 40 FITTINGS UNIONS & SADDLES

## SPECIAL REINFORCED REDUCER (T.T.) BUSHING (Flush Style)

Mipt x SR Fipt

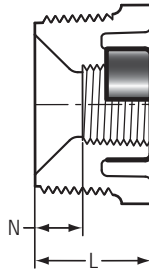

Part Number	Size	L	N	Approx. Wt. (Lbs.)
439-209SR	1-1/2x1/2	1-11/32	19/32	.13
439-210SR	1-1/2x3/4	1-11/32	19/32	.12
439-247SR	2x1/2	1-3/8	21/32	.18
439-248SR	2x3/4	1-3/8	5/8	.18
439-249SR	2x1	1-3/8	15/32	.19

## IPT ADAPTER

Mipt x Fipt

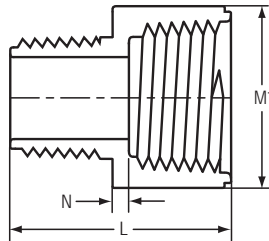

Part Number	Size	L	M1	N	Approx. Wt. (Lbs.)
446-003	3/8	1-13/32	29/32	5/32	.02
446-012	1-1/4	2-3/16	2	5/32	.11
446-053	3/8x1/2	1-1/2	1-1/16	3/16	.03
446-074	1/2x3/4	1-17/32	1-5/16	5/32	.04



# PVC WHITE SCHEDULE 40 FITTINGS UNIONS & SADDLES



**CAP**  
Socket

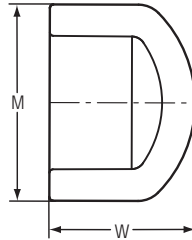

Part Number	Size	M	W	Approx. Wt. (Lbs.)
447-003	3/8	7/8	1	.01
447-005	1/2	1-3/32	1-1/16	.02
447-007	3/4	1-5/16	1-5/16	.04
447-010	1	1-9/16	1-9/16	.06
447-012	1-1/4	1-31/32	1-3/4	.09
447-015	1-1/2	2-1/4	1-29/32	.12
447-020	2	2-23/32	2-1/32	.17
447-025	2-1/2	3-5/16	2-9/16	.33
447-030	3	4	2-29/32	.49
447-040	4	5-1/16	3-1/8	.79
447-045F	4-1/2	5-7/16	3-5/8	.31
447-050	5	6-1/8	4-13/32	1.43
447-060	6	7-1/4	5	2.34
447-080	8	9-9/16	6-3/8	4.26
447-100F	10	11-13/16	5-1/4	5.22
447-120F	12	13-7/8	6-7/8	8.22
447-140F	14	15	7-3/8	8.75
447-160F	16	17-1/16	8-1/2	12.15
447-180F	18	19-1/8	9	17.58
447-200F	20	21-3/16	12-1/4	26.48
447-240F	24	25-5/16	14-1/8	40.26



# PVC WHITE SCHEDULE 40 FITTINGS UNIONS & SADDLES

**CAP**  
Fipt

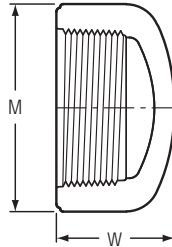

Part Number	Size	M	W	Approx. Wt. (Lbs.)
448-003	3/8	15/16	25/32	.01
448-005	1/2	1-1/16	1-1/16	.03
448-007	3/4	1-11/32	1-1/16	.03
448-010	1	1-5/8	1-5/16	.06
448-012	1-1/4	2-1/16	1-1/2	.09
448-015	1-1/2	2-1/4	1-9/16	.11
448-020	2	2-3/4	1-23/32	.16
448-025	2-1/2	3-9/32	2-5/16	.35
448-030	3	4	2-13/32	.49
448-040	4	5-5/32	2-25/32	.76
448-050	5	6-11/32	3-3/32	1.39
448-060	6	7-5/16	3-5/32	1.59
448-080F	8	9-3/8	4-3/8	3.83
448-100F	10	11-7/8	5-3/4	7.44
448-120F	12	13-13/16	6-3/16	37.94

# PVC WHITE SCHEDULE 40 FITTINGS UNIONS & SADDLES



## SPECIAL REINFORCED CAP

SR Fipt

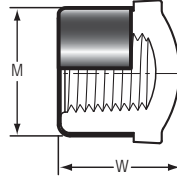

Part Number	Size	M	W	Approx. Wt. (Lbs.)
448-012SR	1-1/4	2-1/16	1-3/8	.09

## PLUG

Spigot

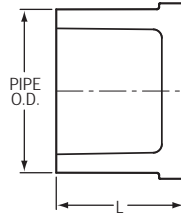

Part Number	Size	L	Approx. Wt. (Lbs.)
449-003	3/8	31/32	.01
449-005	1/2	7/8	.02
449-007	3/4	1-1/8	.02
449-010	1	1-3/8	.05
449-012	1-1/4	1-17/32	.09
449-015	1-1/2	1-5/8	.11
449-020	2	1-3/4	.17
449-025	2-1/2	2-3/8	.35
449-030	3	2-3/32	.39
449-040	4	2-5/8	.76
449-060	6	3-1/2	1.74
449-060F	6	9-1/2	4.53
449-080F	8	10-15/16	8.55
449-100F	10	11-1/4	11.98
449-120F	12	13-7/8	18.15
449-140F	14	15-3/8	19.10
449-160F	16	17-1/2	32.07
449-180F	18	19	42.58
449-200F	20	23-1/4	63.91
449-240F	24	27-1/8	105.13



# PVC WHITE SCHEDULE 40 FITTINGS UNIONS & SADDLES

## COUNTER SUNK PLUG

Spigot

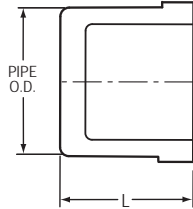

Part Number	Size	L	Approx. Wt. (Lbs.)
449-007CS	3/4	1-1/4	.03
449-010CS	1	1-5/32	.04

## PLUG

Mipt

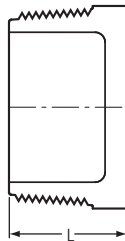

Part Number	Size	L	Approx. Wt. (Lbs.)
450-003	3/8	25/32	.01
450-005	1/2	13/16	.02
450-007	3/4	7/8	.02
450-010	1	1-7/32	.06
450-012	1-1/4	1-9/32	.07
450-015	1-1/2	1-11/32	.10
450-020	2	1-3/8	.15
450-025	2-1/2	1-31/32	.27
450-030	3	1-7/8	.39
450-040	4	2-1/8	.77
450-060	6	2-1/16	1.71
450-080F	8	9	8.33
450-100F	10	8-1/2	12.68
450-120F	12	10-7/8	19.62

# PVC WHITE SCHEDULE 40 FITTINGS UNIONS & SADDLES



## UNION

Socket x Socket w/O-ring Seal

Pressure Rating 150 psi @ 73°F

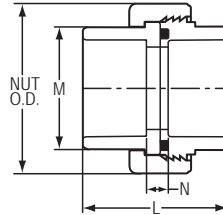

Part Number		Size	L	M	N	Nut O.D.	Approx. Wt. (Lbs.)
w/O-ring Seal							
BUNA-N	EPDM						
457-005	497-005	1/2	1-27/32	1-3/32	11/32	1-23/32	.08
457-007	497-007	3/4	2-3/16	1-5/16	11/32	1-31/32	.12
457-010	497-010	1	2-7/16	1-5/8	11/32	2-3/8	.18
457-012	497-012	1-1/4	2-29/32	1-31/32	13/32	2-11/16	.24
457-015	497-015	1-1/2	3-1/32	2-1/4	3/8	3-3/32	.32
457-020	497-020	2	3-9/32	2-23/32	17/32	3-5/8	.54
457-025	497-025	2-1/2	4-1/16	3-11/32	9/16	4-3/8	.85
457-030	497-030	3	4-11/32	4	11/16	5-3/32	1.26
457-040	497-040	4	4-5/8	5-1/32	19/32	6-3/16	1.78
457-060	497-060	6	6-7/8	7-9/32	13/16	8-7/8	5.22



# PVC WHITE SCHEDULE 40 FITTINGS UNIONS & SADDLES

## UNION

Fipt x Fipt w/O-ring Seal

Pressure Rating 150 psi @ 73°F

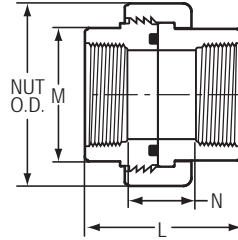

Part Number		Size	L	M	N	Nut O.D.	Approx. Wt. (Lbs.)
w/O-ring Seal							
BUNA-N	EPDM						
458-005	498-005	1/2	1-25/32	1-3/32	5/16	1-23/32	.09
458-007	498-007	3/4	1-25/32	1-5/16	11/32	1-31/32	.12
458-010	498-010	1	2-1/8	1-5/8	11/32	2-3/8	.19
458-012	498-012	1-1/4	2-1/4	1-31/32	13/32	2-11/16	.24
458-015	498-015	1-1/2	2-9/32	2-1/4	3/8	3-3/32	.31
458-020	498-020	2	2-1/2	2-23/32	1/2	3-5/8	.47
458-025	498-025	2-1/2	3-5/32	3-11/32	9/16	4-3/8	.86
458-030	498-030	3	3-13/32	4	5/8	5-3/32	1.26
458-040	498-040	4	3-9/16	5-1/32	5/8	6-3/16	1.74
458-060	498-060	6	4-27/32	7-1/4	1-1/2	8-7/8	4.83

## TRANSITION UNION

Socket x Fipt w/Metal Thread Insert and O-ring Seal

Pressure Rating 235 psi @ 73°F

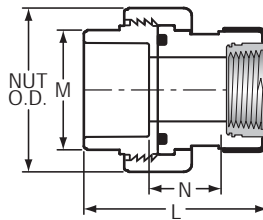

Part Number		Size	L	M	N	Nut O.D.	Approx. Wt. (Lbs.)
w/O-ring Seal							
BUNA-N	EPDM						
459-010BR	499-010BR	1	2-13/16	1-7/8	1-1/32	2-7/8	.52
459-012BR	499-012BR	1-1/4	3-9/32	2-7/32	1-1/16	3-5/16	.68
459-015BR	499-015BR	1-1/2	3-1/2	2-9/16	1-3/32	3-17/32	.89
459-020BR	499-020BR	2	3-5/8	2-7/8	1-1/4	4-5/16	1.59

Not intended to convey or dispense water for human consumption through drinking or cooking

# PVC WHITE SCHEDULE 40 FITTINGS UNIONS & SADDLES



## SPECIAL REINFORCED UNION

Socket x SR Fipt w/O-ring Seal

Pressure Rating 235 psi @ 73°F

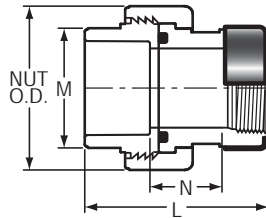

Part Number		Size	L	M	N	Nut O.D.	Approx. Wt. (Lbs.)
w/O-ring Seal							
BUNA-N	EPDM						
459-002SR	499-002SR	1/4	2-1/8	7/8	29/32	1-11/16	.10
459-003SR	499-003SR	3/8	2-5/16	1	1	1-13/16	.06
459-005SR	499-005SR	1/2	2-9/32	1-9/32	21/32	1-31/32	.17
459-007SR	499-007SR	3/4	2-19/32	1-17/32	27/32	2-1/2	.28
459-010SR	499-010SR	1	2-15/16	1-11/16	7/8	2-7/8	.42
459-012SR	499-012SR	1-1/4	3-7/32	2-1/16	31/32	3-5/16	.55
459-015SR	499-015SR	1-1/2	3-7/16	2-9/16	1-1/16	3-9/16	.68
459-020SR	499-020SR	2	4-1/8	3	1-9/16	4-5/32	1.11
459-030SR	499-030SR	3	5-9/32	4-5/16	1-31/32	5-13/16	2.55
459-040SR	499-040SR	4	5-15/16	5-1/4	2-1/8	5-3/4	4.04

## SADDLE

(IPS O.D. x Socket)

Non-Pressure Rated. Contact Spears®

Technical Services for additional information

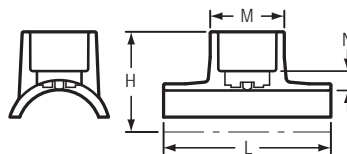

Part Number	Size	H	L	M	N	Approx. Wt. (Lbs.)
463-288	2-1/2x3/4	2-9/16	5-5/16	1-11/32	1/16	.24
463-333 <sup>1</sup>	3x1/2	3-19/32	6-11/32	2-3/8	1-5/16	.65
463-335 <sup>1</sup>	3x1	3-5/8	6-11/32	2-3/8	7/8	.67
463-336	3x1-1/4	3-21/32	6-5/16	2-3/8	21/32	.59
463-337	3x1-1/2	3-5/16	6-3/8	2-3/8	5/16	.52
463-338	3x2	5	6-5/16	2-3/4	1-7/8	.71
463-415	4x1/2	4-1/8	6-5/16	2-3/8	1-1/8	.65
463-417	4x1	4-7/32	6-5/16	2-3/8	13/16	.67
463-418	4x1-1/4	4-3/16	6-1/4	2-3/8	11/16	.60



# PVC WHITE SCHEDULE 40 FITTINGS UNIONS & SADDLES

## SADDLE (continued)

(IPS O.D. x Socket)

Non-Pressure Rated. Contact Spears®

Technical Services for additional information

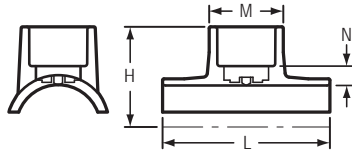

Part Number	Size	H	L	M	N	Approx. Wt. (Lbs.)
463-419	4x1-1/2	3-3/4	6-1/4	2-13/32	1/4	.57
463-420	4x2	5-1/2	6-1/4	2-3/4	1-13/16	.73
463-485	5x1-1/2	5-3/8	7-1/8	2-25/32	1-5/32	1.05
463-486	5x2	5	7-1/8	2-3/4	9/32	.89
463-523 <sup>1</sup>	6x1/2	4-5/16	6-15/32	2-3/8	1-1/4	.84
463-525	6x1	5-11/32	6-3/8	2-7/8	7/8	.86
463-526	6x1-1/4	5-3/8	6-5/16	2-3/8	3/4	.80
463-527	6x1-1/2	4-15/16	6-5/16	2-13/32	5/16	.69
463-528	6x2	6-9/16	6-5/16	2-3/4	1-7/8	.92
463-530 <sup>1</sup>	6x3	5-15/16	11-15/16	5-1/16	5/8	2.79
463-532	6x4	5-1/2	11-15/16	5	1/4	1.95
463-573 <sup>1</sup>	8x1/2	6-9/16	6-11/32	2-3/8	1-1/2	.93
463-575 <sup>1</sup>	8x1	3-3/8	6-11/32	2-3/8	1-7/32	.95
463-576 <sup>1</sup>	8x1-1/4	3-21/32	6-11/32	2-3/8	1	.84
463-577	8x1-1/2	6-7/32	6-5/16	2-3/8	19/32	.83
463-578	8x2	7-11/16	6-5/16	2-3/4	2	.96
463-580 <sup>1</sup>	8x3	6	11-7/8	5	3/4	2.96
463-582	8x4	5-9/16	11-15/16	5-1/32	7/32	2.11
463-624	10x4	7-5/8	11-7/8	5	5/16	2.19

<sup>1</sup>Outlet sized with bushing



# PVC WHITE SCHEDULE 40 FITTINGS UNIONS & SADDLES



## SADDLE

(IPS O.D. x Fipt)

Non-Pressure Rated. Contact Spears®

Technical Services for additional information

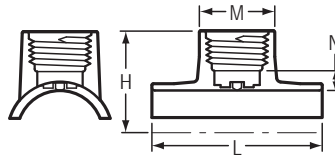

Part Number	Size	H	L	M	N	Approx. Wt. (Lbs.)
464-071	1/2x1/8	1	2-1/8	9/16	1/8	.03
464-097	3/4x1/8	1-1/8	2-1/8	9/16	5/32	.04
464-288	2-1/2x3/4	2-9/16	5-9/32	1-11/32	5/16	.24
464-337	3x1-1/2	3-9/32	6-5/16	2-3/8	13/32	.53
464-419	4x1-1/2	3-3/4	6-1/4	2-3/8	7/16	.56
464-486	5x2	4-15/16	7-1/16	2-3/4	1-3/32	1.00
464-527	6x1-1/2	4-15/16	6-5/16	2-3/8	3/8	.70
464-532	6x4	5-9/32	11-15/16	5	9/32	1.92
464-577	8x1-1/2	6-7/32	6-5/16	2-3/8	19/32	.79
464-582	8x4	6-1/4	11-7/8	5	1/4	2.16
464-624	10x4	7-5/16	11-7/8	5	1/4	2.04

## SNAP-ON SADDLE

(IPS O.D. x Socket)

Non-Pressure Rated. Contact Spears®

Technical Services for additional information

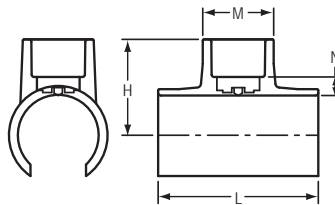

Part Number	Size	H	L	M	N	Approx. Wt. (Lbs.)
463-005	1/2x1/2	1-11/32	2-1/2	1-3/32	5/32	.05
463-007	3/4x3/4	1-3/4	3-1/8	1-5/16	7/32	.08
463-010	1x1	1-29/32	3-5/8	1-5/8	1/8	.14
463-012	1-1/4x1-1/4	2-1/4	4-1/4	2	11/32	.20
463-015	1-1/2x1-1/2	2-13/32	4-7/16	2-7/32	3/16	.25
463-020	2x2	2-23/32	5-1/4	2-11/16	7/32	.40
463-101	3/4x1/2	1-11/32	2-3/4	1-3/32	7/32	.06
463-130	1x1/2	1-13/32	3-1/2	1-3/32	1-3/16	.09



# PVC WHITE SCHEDULE 40 FITTINGS UNIONS & SADDLES

## SNAP-ON SADDLE

(IPS O.D. x Fipt)

Non-Pressure Rated. Contact Spears®

Technical Services for additional information.

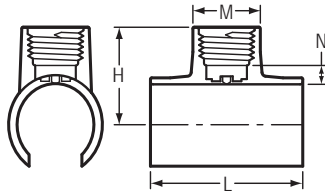

Part Number	Size	H	L	M	N	Approx. Wt. (Lbs.)
464-005	1/2x1/2	1-3/8	2-1/2	1-1/16	3/16	.05
464-007	3/4x3/4	1-3/4	3-5/32	1-5/16	13/32	.09
464-010	1x1	1-15/16	3-5/8	1-5/8	1/4	.15
464-001	3/4x1/2	1-7/16	2-3/8	1-3/32	3/16	.06
464-030	1x1/2	1-19/32	3-1/2	1-1/16	5/32	.08
464-031	1x3/4	1-7/16	3	1-1/4	3/16	.09
464-210	1-1/2x3/4	1-15/16	3-17/32	1-5/16	5/32	.15

## CLAMP-ON SADDLE x SOCKET SINGLE OUTLET

Dimensions Also Applicable to  
466S-XXX 466E-XXX 466SE-XXX

Pressure Rating  
2" - 4" 235 psi @ 73°F  
6" 200 psi @ 73°F  
8" - 12" 150 psi @ 73°F

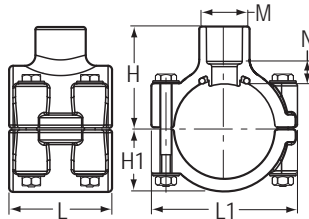

Part Number	Size	H	H1	L	L1	M	N	Approx. Wt. (Lbs.)
466-247	2x1/2	2-3/8	1-1/2	2-7/16	3-7/16	1-3/16	5/16	.60
466-248	2x3/4	2-1/2	1-1/2	2-7/16	3-7/16	1-3/8	5/16	.61
466-249	2x1	2-5/8	1-1/2	2-7/16	3-7/16	1-11/16	5/16	.63
466-250	2x1-1/4	2-3/4	1-1/2	2-7/16	3-7/16	2-1/16	5/16	.71
466-251	2x1-1/2	2-15/16	1-1/2	2-7/16	3-7/16	2-3/8	3/8	.71
466-291	2-1/2x1-1/2	3-3/16	1-11/16	4-1/16	4	2-3/8	3/8	1.02
466-333	3x1/2	3-5/16	2-1/16	3	4-5/8	1-3/8	13/16	.88
466-334	3x3/4	3-1/16	2-1/16	3	4-5/8	1-3/8	9/32	.86
466-335	3x1	3-3/16	2-1/16	3	4-5/8	1-11/16	5/16	.87

# PVC WHITE SCHEDULE 40 FITTINGS UNIONS & SADDLES



## CLAMP-ON SADDLE x SOCKET SINGLE OUTLET (continued)

Dimensions Also Applicable to  
466S-XXX 466E-XXX 466SE-XXX

Pressure Rating  
2" - 4" 235 psi @ 73°F  
6" 200 psi @ 73°F  
8" - 12" 150 psi @ 73°F

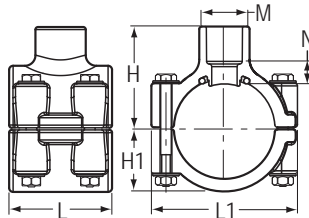

Part Number	Size	H	H1	L	L1	M	N	Approx. Wt. (Lbs.)
466-336	3x1-1/4	4-1/32	2-1/16	4-3/32	4-5/8	3	1-1/32	1.47
466-337	3x1-1/2	4-1/32	2-1/16	4-3/32	4-5/8	3	29/32	1.41
466-338	3x2	3-5/8	2-1/16	4-3/32	4-5/8	3	3/8	1.25
466-415	4x1/2	4-3/32	2-5/8	3	5-9/16	2-3/8	31/32	1.31
466-416	4x3/4	4-3/32	2-5/8	3	5-9/16	2-3/8	27/32	1.28
466-417	4x1	3-13/16	2-5/8	3	5-5/8	1-11/16	7/16	1.24
466-418	4x1-1/4	4-13/32	2-5/8	4-3/32	5-5/8	2-3/8	29/32	1.70
466-419	4x1-1/2	4-1/8	2-5/8	4-3/32	5-9/16	2-3/8	1/2	1.63
466-420	4x2	4-3/16	2-5/8	4-1/8	5-5/8	3	7/16	1.70
466-421	4x2-1/2	5	2-5/8	5-7/16	5-23/32	4-9/32	3/4	2.82
466-422	4x3	4-5/8	2-19/32	5-7/16	5-11/16	4-1/4	1/2	2.41
466-523	6x1/2	5-13/32	3-7/8	3	7-3/4	1-11/16	1-7/32	2.35
466-524	6x3/4	5-7/16	3-7/8	3	7-3/4	1-11/16	1-1/8	2.33
466-525	6x1	5-1/8	3-7/8	3	7-15/16	1-11/16	11/16	2.29
466-526	6x1-1/4	5-15/16	3-7/8	4-1/8	7-3/4	3	1-3/8	3.26
466-527 <sup>1</sup>	6x1-1/2	5-23/32	3-7/8	4-1/8	7-31/32	3	1-1/32	3.20
466-528	6x2	5-1/2	3-7/8	4-1/8	7-3/4	3	11/16	3.04
466-529	6x2-1/2	6-7/16	3-7/8	6	7-15/16	4-1/4	1-1/8	4.75
466-530	6x3	5-15/16	3-7/8	6	7-15/16	4-1/4	25/32	4.33
466-532	6x4	6	3-29/32	6	7-15/16	5-3/16	5/8	5.12
466-573	8x1/2	8-3/32	4-7/8	8-1/2	10-1/8	5-1/4	2-3/16	9.35
466-574	8x3/4	8-3/32	4-7/8	8-1/2	10-1/8	5-1/4	2-3/4	9.36
466-575	8x1	8-3/32	4-7/8	8-1/2	10-1/8	5-1/4	2-5/8	9.37
466-576	8x1-1/4	8-3/32	4-7/8	8-1/2	10-1/8	5-1/4	2-1/2	9.39
466-577	8x1-1/2	8-3/32	4-7/8	8-1/2	10-1/8	5-1/4	2-3/8	9.32
466-578	8x2	7-11/16	4-7/8	8-1/2	10-1/8	5-1/4	1-7/8	9.17
466-579	8x2-1/2	8-1/8	4-7/8	8-1/2	10-1/8	5-1/4	1-11/16	9.24
466-580	8x3	7-1/16	4-7/8	8-1/2	10-1/8	5-1/4	1-7/16	9.15



# PVC WHITE SCHEDULE 40 FITTINGS UNIONS & SADDLES

## CLAMP-ON SADDLE x SOCKET SINGLE OUTLET (continued)

Dimensions Also Applicable to  
466S-XXX 466E-XXX 466SE-XXX

Pressure Rating  
2" - 4" 235 psi @ 73°F  
6" 200 psi @ 73°F  
8" - 12" 150 psi @ 73°F

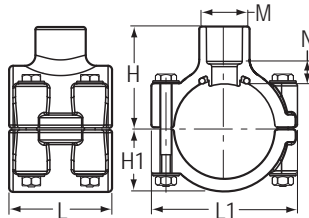

<sup>1</sup>Outlet sized with bushing

Part Number	Size	H	H1	L	L1	M	N	Approx. Wt. (Lbs.)
466-582	8x4	7-5/16	4-7/8	8-1/2	10-1/8	5-1/4	11/16	8.35
466-585	8x6	8-3/32	4-7/8	8-1/2	10-1/8	7-5/8	11/16	9.47
466-620 <sup>1</sup>	10x1-1/2	8-7/8	6-1/8	8-1/2	11-7/8	5-1/4	3-1/4	12.78
466-624	10x4	8-15/32	6-1/32	8-1/2	12-5/16	5-1/4	13/16	11.79
466-626	10x6	9-1/8	6	8-7/16	12	7-5/8	1-1/8	12.86
466-664	12x4	9-9/16	7-5/32	8-1/2	14-5/16	5-1/4	7/8	15.48
466-666	12x6	10-3/8	7-5/32	8-1/2	14-5/16	7-5/8	7/8	16.30

<sup>1</sup>Outlet sized with bushing

- 1) Clamp-On Saddle Standard Hardware: Zinc Bolts w/BUNA-N O-ring Seal  
e.g.) Part Number 466-247 = 2x1/2 PVC Clamp On Saddle, Socket, BUNA-N O-ring, Zinc Bolts.
- 2) Clamp-On Saddles w/Stainless Steel (SS) Bolts, Add The Letter "S" Before The Dash.  
e.g.) Part Number 466S-247 = 2x1/2 PVC Clamp On Saddle, Socket, BUNA-N O-ring, Stainless Steel Bolts.
- 3) Clamp-On Saddles Standard Hardware: Zinc Bolts w/EPDM O-ring Seal, Add The Letter "E" Before The Dash.  
e.g.) Part Number 466E-247 = 2x1/2 PVC Clamp-On Saddle, Socket, EPDM O-ring, Zinc Bolts.
- 4) Clamp-On Saddles w/Stainless Steel Bolts & EPDM O-ring Seal, Add The Letter "SE" Before The Dash.  
e.g.) Part Number 466SE-247 = 2x1/2 PVC Clamp On Saddle, Socket EPDM O-ring, Stainless Steel Bolts.

# PVC WHITE SCHEDULE 40 FITTINGS UNIONS & SADDLES



## CLAMP-ON SADDLE x SR FIPT SINGLE OUTLET

Dimensions Also Applicable to  
467S-XXXSR 467E-XXXSR 467SE-XXXSR

Pressure Rating  
2" - 4" 235 psi @ 73°F  
6" 200 psi @ 73°F  
8" - 12" 150 psi @ 73°F

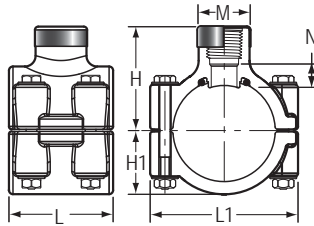

Part Number	Size	H	H1	L	L1	M	N	Approx. Wt. (Lbs.)
467-247SR	2x1/2	2-3/8	1-1/2	2-7/16	3-7/16	1-3/16	5/16	.62
467-248SR	2x3/4	2-1/2	1-1/2	2-7/16	3-7/16	1-3/8	5/8	.63
467-249SR	2x1	2-5/8	1-1/2	2-7/16	3-7/16	1-11/16	9/16	.65
467-250SR	2x1-1/4	2-3/4	1-1/2	2-7/16	3-7/16	2-1/16	11/16	.57
467-251SR	2x1-1/2	2-15/16	1-1/2	2-7/16	3-7/16	2-3/8	3/4	.76
467-291SR	2-1/2x1-1/2	3-3/16	1-11/16	4-1/16	4	2-3/8	13/16	1.09
467-333SR	3x1/2	3-5/16	2-1/16	3	4-5/8	1-3/8	15/16	.89
467-334SR	3x3/4	3-1/16	2-1/16	3	4-5/8	1-3/8	9/16	.88
467-335SR	3x1	3-3/16	2-1/16	3	4-5/8	1-11/16	9/16	.90
467-336SR	3x1-1/4	4-1/32	2-1/16	4-3/32	4-5/8	3	1-5/16	1.52
467-337SR	3x1-1/2	4-1/32	2-1/16	4-3/32	4-5/8	3	2-11/16	1.48
467-338SR	3X2	3-5/8	2-1/16	4-3/32	4-5/8	3	7/8	1.34
467-415SR	4x1/2	4-3/32	2-5/8	3	5-9/16	2-3/8	1-1/8	1.32
467-416SR	4x3/4	4-3/32	2-5/8	3	5-9/16	2-3/8	1-1/8	1.31
467-417SR	4x1	3-13/16	2-5/8	3	5-5/8	1-11/16	11/16	1.28
467-418SR	4x1-1/4	4-13/32	2-5/8	4-3/32	5-5/8	2-3/8	1-7/32	1.75
467-419SR	4x1-1/2	4-1/8	2-5/8	4-3/32	5-9/16	2-3/8	15/16	1.70
467-420SR	4x2	4-3/16	2-5/8	4-1/8	5-5/8	3	15/16	1.80
467-421SR	4x2-1/2	5	2-5/8	5-7/16	5-23/32	4-9/32	1-7/32	2.92
467-422SR	4x3	4-5/8	2-19/32	5-7/16	5-11/16	4-1/4	31/32	2.59
467-523SR	6x1/2	5-13/32	3-7/8	3	7-3/4	1-11/16	1-3/8	2.37
467-524SR	6x3/4	5-7/16	3-7/8	3	7-3/4	1-11/16	1-3/8	2.35
467-525SR	6x1	5-1/8	3-7/8	3	7-15/16	1-11/16	15/16	2.32
467-526SR	6x1-1/4	5-15/16	3-7/8	4-1/8	7-3/4	3	1-11/16	3.32
467-527SR	6x1-1/2	5-15/16	3-7/8	4-1/8	7-3/4	3	1-3/4	3.27
467-528SR	6x2	5-1/2	3-7/8	4-1/8	7-3/4	3	1-7/32	3.14
467-529SR	6x2-1/2	6-7/16	3-7/8	6	7-15/16	4-1/4	1-9/16	4.85
467-530SR	6x3	5-15/16	3-7/8	6	7-15/16	4-1/4	1-1/4	4.50



# PVC WHITE SCHEDULE 40 FITTINGS UNIONS & SADDLES

## CLAMP-ON SADDLE x SR FIPT SINGLE OUTLET (continued)

Dimensions Also Applicable to  
467S-XXXSR 467E-XXXSR 467SE-XXXSR

Pressure Rating  
2" - 4" 235 psi @ 73°F  
6" 200 psi @ 73°F  
8" - 12" 150 psi @ 73°F

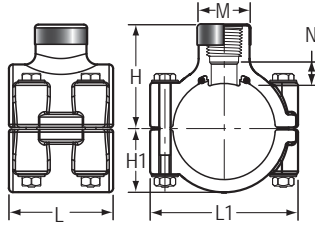

Part Number	Size	H	H1	L	L1	M	N	Approx. Wt. (Lbs.)
467-532SR	6x4	6	3-29/32	6	7-15/16	5-3/16	1-3/8	5.48
467-573SR	8x1/2	8-3/32	4-7/8	8-1/2	10-1/8	5-1/4	3	9.42
467-574SR	8x3/4	8-3/32	4-7/8	8-1/2	10-1/8	5-1/4	3	9.43
467-575SR	8x1	8-3/32	4-7/8	8-1/2	10-1/8	5-1/4	2-13/16	9.43
467-576SR	8x1-1/4	8-3/32	4-7/8	8-1/2	10-1/8	5-1/4	2-3/4	9.56
467-577SR	8x1-1/2	8-3/32	4-7/8	8-1/2	10-1/8	5-1/4	2-3/4	9.39
467-578SR	8x2	7-11/16	4-7/8	8-1/2	10-1/8	5-1/4	2-3/8	9.21
467-579SR	8x2-1/2	8-1/8	4-7/8	8-1/2	10-1/8	5-1/4	2-1/2	9.15
467-580SR	8x3	7-1/16	4-7/8	8-1/2	10-1/8	5-1/4	1-15/16	10.06
467-582SR	8x4	7-5/16	4-7/8	8-1/2	10-1/8	5-1/4	1-1/2	8.51
467-585SR	8x6	8-3/32	4-7/8	8-1/2	10-1/8	7-5/8	2-3/32	10.20
467-624SR	10x4	8-15/32	6-1/32	8-1/2	12-5/16	5-1/4	2-3/16	12.09
467-626SR	10x6	9-9/32	6-1/32	8-1/2	12-5/16	7-5/8	3-3/16	13.45
467-664SR	12x4	9-9/16	7-5/32	8-1/2	14-5/16	5-1/4	1-5/8	15.69
467-666SR	12x6	10-3/8	7-5/32	8-1/2	14-5/16	7-5/8	2-1/4	16.92

- 1) Clamp-On Saddle Standard Hardware: Zinc Bolts w/BUNA-N O-ring Seal  
e.g.) Part Number 467-247SR = 2x1/2 PVC Clamp On Saddle, Socket, BUNA-N O-ring, Zinc Bolts.
- 2) Clamp-On Saddles w/Stainless Steel (SS) Bolts, Add The Letter "S" Before The Dash.  
e.g.) Part Number 467S-247SR = 2x1/2 PVC Clamp On Saddle, Socket, BUNA-N O-ring, Stainless Steel Bolts.
- 3) Clamp-On Saddles Standard Hardware: Zinc Bolts w/EPDM O-ring Seal, Add The Letter "E" Before The Dash.  
e.g.) Part Number 467E-247SR = 2x1/2 PVC Clamp-On Saddle, Socket, EPDM O-ring, Zinc Bolts.
- 4) Clamp-On Saddles w/Stainless Steel Bolts & EPDM O-ring Seal, Add The Letter "SE" Before The Dash.  
e.g.) Part Number 467SE-247SR = 2x1/2 PVC Clamp On Saddle, Socket EPDM O-ring, Stainless Steel Bolts.

# PVC WHITE SCHEDULE 40 FITTINGS UNIONS & SADDLES



## CLAMP-ON SADDLE x SOCKET DOUBLE OUTLET

Dimensions Also Applicable to  
468S-Xxx 468E-Xxx 468SE-Xxx

Pressure Rating  
2" - 4" 235 psi @ 73°F  
6" 200 psi @ 73°F  
8" - 12" 150 psi @ 73°F

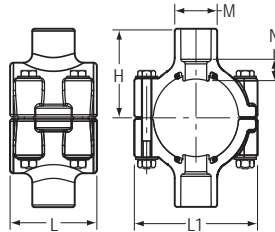

Part Number	Size	H	L	L1	M	N	Approx. Wt. (Lbs.)
468-247	2x1/2	2-3/8	2-7/16	3-7/16	1-3/16	5/16	.63
468-248	2x3/4	2-1/2	2-7/16	3-7/16	1-3/8	5/16	.65
468-249	2x1	2-5/8	2-7/16	3-7/16	1-11/16	5/16	.68
468-250	2x1-1/4	2-3/4	2-7/16	3-7/16	2-1/16	5/16	.73
468-251	2x1-1/2	2-15/16	2-7/16	3-7/16	2-3/8	3/8	.85
468-291	2-1/2x1-1/2	3-3/16	4-1/16	4	2-3/8	3/8	1.15
468-333	3x1/2	3-5/16	3	4-5/8	1-3/8	13/16	.93
468-334	3x3/4	3-1/16	3	4-5/8	1-3/8	9/32	.89
468-335	3x1	3-3/16	3	4-5/8	1-11/16	5/16	.91
468-336	3x1-1/4	4-1/32	4-3/32	4-5/8	3	1-1/32	1.93
468-337	3x1-1/2	4-1/32	4-3/32	4-5/8	3	29/32	1.80
468-338	3x2	3-5/8	4-3/32	4-5/8	3	3/8	1.48
468-415	4x1/2	4-3/32	3	5-9/16	2-3/8	31/32	1.43
468-416	4x3/4	4-3/32	3	5-9/16	2-3/8	27/32	1.37
468-417	4x1	3-13/16	3	5-5/8	1-11/16	7/16	1.30
468-418	4x1-1/4	4-13/32	4-3/32	5-5/8	2-3/8	29/32	1.91
468-419	4x1-1/2	4-1/8	4-3/32	5-9/16	2-3/8	1/2	1.76
468-420	4x2	4-3/16	4-1/8	5-5/8	3	7/16	1.91
468-421	4x2-1/2	5	5-7/16	5-23/32	4-9/32	3/4	3.77
468-422	4x3	4-5/8	5-7/16	5-11/16	4-1/4	1/2	2.95
468-523	6x1/2	5-13/32	3	7-3/4	1-11/16	1-7/32	2.48
468-524	6x3/4	5-7/16	3	7-3/4	1-11/16	1-1/8	2.44
468-525	6x1	5-1/8	3	7-15/16	1-11/16	11/16	2.35
468-526	6x1-1/4	5-15/16	4-1/8	7-3/4	3	1-3/8	3.70
468-527	6x1-1/2	5-15/16	4-1/8	7-3/4	3	1-1/4	3.57
468-528	6x2	5-1/2	4-1/8	7-3/4	3	11/16	3.26
468-529	6x2-1/2	6-7/16	6	7-15/16	4-1/4	1-1/8	5.61
468-530	6x3	5-15/16	6	7-15/16	4-1/4	25/32	4.78



# PVC WHITE SCHEDULE 40 FITTINGS UNIONS & SADDLES

## CLAMP-ON SADDLE x SOCKET DOUBLE OUTLET (continued)

Dimensions Also Applicable to  
468S-Xxx 468E-Xxx 468SE-Xxx

Pressure Rating  
2" - 4" 235 psi @ 73°F  
6" 200 psi @ 73°F  
8" - 12" 150 psi @ 73°F

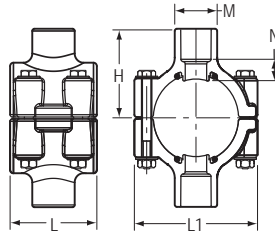

Part Number	Size	H	L	L1	M	N	Approx. Wt. (Lbs.)
468-532	6x4	6	6	7-15/16	5-3/16	5/8	5.63
468-573	8x1/2	8-3/32	8-1/2	10-1/8	5-1/4	2-3/16	11.07
468-574	8x3/4	8-3/32	8-1/2	10-1/8	5-1/4	2-3/4	11.04
468-575	8x1	8-3/32	8-1/2	10-1/8	5-1/4	2-5/8	11.06
468-576	8x1-1/4	8-3/32	8-1/2	10-1/8	5-1/4	2-1/2	11.08
468-577	8x1-1/2	8-3/32	8-1/2	10-1/8	5-1/4	2-3/8	10.96
468-578	8x2	7-11/16	8-1/2	10-1/8	5-1/4	1-7/8	10.64
468-579	8x2-1/2	8-1/8	8-1/2	10-1/8	5-1/4	1-11/16	10.78
468-580	8x3	7-1/16	8-1/2	10-1/8	5-1/4	1-7/16	10.62
468-582	8x4	7-5/16	8-1/2	10-1/8	5-1/4	11/16	9.02
468-585	8x6	8-3/32	8-1/2	10-1/8	7-5/8	11/16	11.25
468-624	10x4	8-15/32	8-1/2	12-5/16	5-1/4	13/16	12.37
468-626	10x6	9-9/32	8-1/2	12-5/16	7-5/8	13/16	14.51
468-664	12x4	9-9/16	8-1/2	14-5/16	5-1/4	7/8	16.06
468-666	12x6	10-3/8	8-1/2	14-5/16	7-5/8	7/8	17.70

- 1) Clamp-On Saddle Standard Hardware: Zinc Bolts w/BUNA-N O-ring Seal  
e.g.) Part Number 468-247 = 2x1/2 PVC Clamp On Saddle, Socket, BUNA-N O-ring, Zinc Bolts.
- 2) Clamp-On Saddles w/Stainless Steel (SS) Bolts, Add The Letter "S" Before The Dash.  
e.g.) Part Number 468S-247 = 2x1/2 PVC Clamp On Saddle, Socket, BUNA-N O-ring, Stainless Steel Bolts.
- 3) Clamp-On Saddles Standard Hardware: Zinc Bolts w/EPDM O-ring Seal, Add The Letter "E" Before The Dash.  
e.g.) Part Number 468E-247 = 2x1/2 PVC Clamp-On Saddle, Socket, EPDM O-ring, Zinc Bolts.
- 4) Clamp-On Saddles w/Stainless Steel Bolts & EPDM O-ring Seal, Add The Letter "SE" Before The Dash.  
e.g.) Part Number 468SE-247 = 2x1/2 PVC Clamp On Saddle, Socket EPDM O-ring, Stainless Steel Bolt



# PVC WHITE SCHEDULE 40 FITTINGS UNIONS & SADDLES



## CLAMP-ON SADDLE x SR FIPT DOUBLE OUTLET

Dimensions Also Applicable to  
469S-XXXSR 469E-XXXSR 469SE-XXXSR

Pressure Rating  
2" - 4" 235 psi @ 73°F  
6" 200 psi @ 73°F  
8" - 12" 150 psi @ 73°F

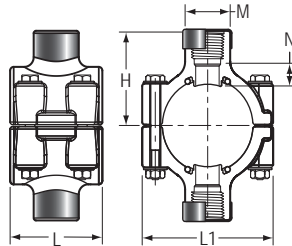

Part Number	Size	H	L	L1	M	N	Approx. Wt. (Lbs.)
469-247SR	2x1/2	2-3/8	2-7/16	3-7/16	1-3/16	5/16	.66
469-248SR	2x3/4	2-1/2	2-7/16	3-7/16	1-3/8	5/16	.67
469-249SR	2x1	2-5/8	2-7/16	3-7/16	1-11/16	5/16	.73
469-250SR	2x1-1/4	2-3/4	2-7/16	3-7/16	2-1/16	5/16	.79
469-251SR	2x1-1/2	2-15/16	2-7/16	3-7/16	2-3/8	3/8	.93
469-291SR	2-1/2x1-1/2	3-3/16	4-1/16	4	2-3/8	3/8	1.30
469-333SR	3x1/2	3-5/16	3	4-5/8	1-3/8	13/16	.96
469-334SR	3x3/4	3-1/16	3	4-5/8	1-3/8	9/32	.93
469-335SR	3x1	3-3/16	3	4-5/8	1-11/16	5/16	.98
469-336SR	3x1-1/4	4-1/32	4-3/32	4-5/8	3	1-1/32	2.04
469-337SR	3x1-1/2	4-1/32	4-3/32	4-5/8	3	2-11/16	1.94
469-338SR	3x2	3-5/8	4-3/32	4-5/8	3	3/8	1.67
469-415SR	4x1/2	4-3/32	3	5-9/16	2-3/8	31/32	1.46
469-416SR	4x3/4	4-3/32	3	5-9/16	2-3/8	27/32	1.44
469-417SR	4x1	3-13/16	3	5-5/8	1-11/16	7/16	1.37
469-418SR	4x1-1/4	4-13/32	4-3/32	5-5/8	2-3/8	29/32	2.00
469-419SR	4x1-1/2	4-1/8	4-3/32	5-9/16	2-3/8	1/2	1.89
469-420SR	4x2	4-3/16	4-1/8	5-5/8	3	7/16	2.10
469-421SR	4x2-1/2	5	5-7/16	5-23/32	4-9/32	3/4	3.98
469-422SR	4x3	4-5/8	5-7/16	5-11/16	4-1/4	1/2	3.31
469-523SR	6x1/2	5-13/32	3	7-3/4	1-11/16	1-7/32	2.51
469-524SR	6x3/4	5-7/16	3	7-3/4	1-11/16	1-1/8	2.48
469-525SR	6x1	5-1/8	3	7-15/16	1-11/16	11/16	2.42
469-526SR	6x1-1/4	5-15/16	4-1/8	7-3/4	3	1-3/8	3.81
469-527SR	6x1-1/2	5-15/16	4-1/8	7-3/4	3	1-1/4	3.71
469-528SR	6x2	5-1/2	4-1/8	7-3/4	3	11/16	3.45
469-529SR	6x2-1/2	6-7/16	6	7-15/16	4-1/4	1-1/8	5.82
469-530SR	6x3	5-15/16	6	7-15/16	4-1/4	25/32	5.12



# PVC WHITE SCHEDULE 40 FITTINGS UNIONS & SADDLES

## CLAMP-ON SADDLE x SR FIPT DOUBLE OUTLET (continued)

Dimensions Also Applicable to  
469S-XXXSR 469E-XXXSR 469SE-XXXSR

Pressure Rating  
2" - 4" 235 psi @ 73°F  
6" 200 psi @ 73°F  
8" - 12" 150 psi @ 73°F

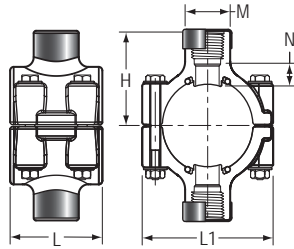

Part Number	Size	H	L	L1	M	N	Approx. Wt. (Lbs.)
469-532SR	6x4	6	6	7-15/16	5-3/16	5/8	6.35
469-573SR	8x1/2	8-3/32	8-1/2	10-1/8	5-1/4	2-3/16	11.07
469-574SR	8x3/4	8-3/32	8-1/2	10-1/8	5-1/4	2-3/4	11.18
469-575SR	8x1	8-3/32	8-1/2	10-1/8	5-1/4	2-5/8	11.09
469-576SR	8x1-1/4	8-3/32	8-1/2	10-1/8	5-1/4	2-1/2	11.44
469-577SR	8x1-1/2	8-3/32	8-1/2	10-1/8	5-1/4	2-3/8	11.46
469-578SR	8x2	7-11/16	8-1/2	10-1/8	5-1/4	1-7/8	10.73
469-579SR	8x2-1/2	8-1/8	8-1/2	10-1/8	5-1/4	1-11/16	10.62
469-580SR	8x3	7-1/16	8-1/2	10-1/8	5-1/4	1-7/16	10.76
469-582SR	8x4	7-5/16	8-1/2	10-1/8	5-1/4	11/16	9.33
469-585SR	8x6	8-3/32	8-1/2	10-1/8	7-5/8	11/16	12.70
469-624SR	10x4	8-15/32	8-1/2	12-5/16	5-1/4	13/16	12.97
469-626SR	10x6	9-9/32	8-1/2	12-5/16	7-5/8	13/16	15.69
469-664SR	12x4	9-9/16	8-1/2	14-5/16	5-1/4	7/8	16.45
469-666SR	12x6	10-3/8	8-1/2	14-5/16	7-5/8	7/8	18.95

- 1) Clamp-On Saddle Standard Hardware: Zinc Bolts w/BUNA-N O-ring Seal  
e.g.) Part Number 469-247SR = 2x1/2 PVC Clamp On Saddle, Socket, BUNA-N O-ring, Zinc Bolts.
- 2) Clamp-On Saddles w/Stainless Steel (SS) Bolts, Add The Letter "S" Before The Dash.  
e.g.) Part Number 469S-247SR = 2x1/2 PVC Clamp On Saddle, Socket, BUNA-N O-ring, Stainless Steel Bolts.
- 3) Clamp-On Saddles Standard Hardware: Zinc Bolts w/EPDM O-ring Seal, Add The Letter "E" Before The Dash.  
e.g.) Part Number 469E-247SR = 2x1/2 PVC Clamp-On Saddle, Socket, EPDM O-ring, Zinc Bolts.
- 4) Clamp-On Saddles w/Stainless Steel Bolts & EPDM O-ring Seal, Add The Letter "SE" Before The Dash.  
e.g.) Part Number 469SE-247SR = 2x1/2 PVC Clamp On Saddle, Socket EPDM O-ring, Stainless Steel Bolt

# PVC WHITE SCHEDULE 40 FITTINGS UNIONS & SADDLES



## INSERT ADAPTER (PVC White)

Insert x I.P.S. Spigot Adapter  
ASTM D 2609

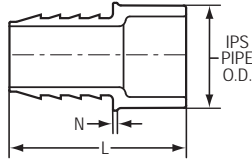

Part Number	Size	L	N	Approx. Wt. (Lbs.)
460-005	1/2	2-7/16	7/32	.03
460-007	3/4	2-23/32	7/32	.04
460-010	1	2-9/16	1/16	.07
460-012	1-1/4	3-1/32	1/4	.11
460-015	1-1/2	3-5/16	5/16	.12
460-020	2	3-1/2	3/8	.20
460-030	3	4-11/16	7/16	.58
460-040	4	5-11/32	5/16	.73

## INSERT ADAPTER (PVC White)

Insert x I.P.S. Spigot

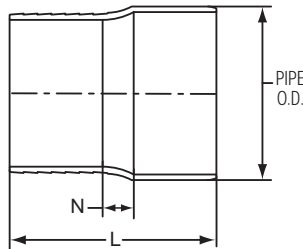

Part Number	Size	L	N	Approx. Wt. (Lbs.)
1432-060	6	7-27/32	1	1.69
1432-080*	8	9-7/8	5/8	5.23

\*Fabricated

## INSERT ADAPTER

Insert x Socket  
ASTM D 2609

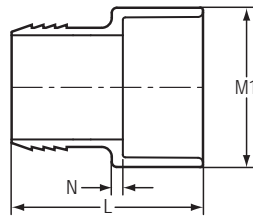

Part Number	Size	L	M1	N	Approx. Wt. (Lbs.)
474-005	1/2	2-3/8	1-1/16	1/8	.03
474-007	3/4	2-7/16	1-5/16	5/32	.05
474-010	1	2-5/8	1-5/8	1/8	.07
474-012	1-1/4	2-11/16	2	3/16	.10
474-015	1-1/2	3-1/16	2-1/4	3/16	.14
474-020	2	3	2-11/16	3/16	.17
474-030	3	4-3/4	4	5/16	.51
474-040	4	5-5/8	5	3/8	.81



# PVC WHITE SCHEDULE 40 FITTINGS UNIONS & SADDLES

## WYE

Socket x Socket x Socket

Pressure Rating  
 1/2" -2" 235 psi @ 73°F  
 2-1/2" -6" 150 psi @ 73°F  
 8" & Up 100 psi @ 73°F

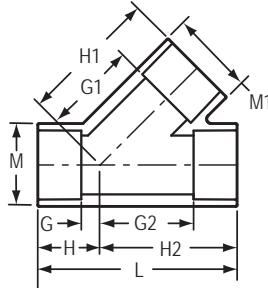

Part Number	Size	G	G1	G2	H	H1	H2	L	M	M1	Approx. Wt. (Lbs.)
475-005	1/2	1/4	1-3/16	1-3/16	1-1/8	2-1/16	2-1/16	3-3/16	1-5/32	1-5/32	.12
475-007	3/4	5/16	1-3/8	1-3/8	1-5/16	2-3/8	2-3/8	3-23/32	1-3/8	1-3/8	.18
475-010	1	9/32	1-13/16	1-13/16	1-13/32	2-15/16	2-15/16	4-11/32	1-23/32	1-23/32	.31
475-012	1-1/4	3/8	2-1/4	2-1/4	1-5/8	3-1/2	3-1/2	5-1/8	2-1/16	2-1/16	.50
475-015	1-1/2	1/2	2-19/32	2-9/16	1-7/8	3-31/32	3-15/16	5-13/16	2-11/32	2-11/32	.69
475-020	2	19/32	3-7/32	3-7/32	2-1/8	4-3/4	4-3/4	6-7/8	2-7/8	2-7/8	1.20
475-025 <sup>1</sup>	2-1/2	1-3/16	5-1/8	4-23/32	2-15/16	6-7/8	6-15/32	9-13/32	4-3/16	4-3/16	3.77
475-030	3	11/16	4-23/32	4-1/4	2-9/16	6-5/8	6-1/8	8-23/32	4-3/16	4-3/16	2.63
475-040	4	1-7/32	5-23/32	5	3-1/2	7-31/32	7-1/4	10-3/4	5-1/4	5-1/4	4.87
475-050F	5	3-3/4	9-3/8	9-3/8	6-3/4	12-3/8	12-3/8	19-1/8	6-1/16	6-1/16	13.26
475-060	6	1-5/32	8-25/32	8-3/16	4-3/16	11-25/32	11-3/16	15-3/8	7-9/16	7-9/16	12.01
475-080	8	1-15/16	11-11/32	11-11/32	5-31/32	15-11/32	15-11/32	21-5/16	9-3/4	9-3/4	25.44
475-080F	8	5-5/8	14-5/16	14-5/16	9-7/8	18-9/16	18-9/16	28-7/16	9-1/4	9-1/4	25.46
475-100	10	2-1/2	16-7/8	13-31/32	7-1/2	22-1/8	18-31/32	26-15/32	11-9/16	11-9/16	26.92
475-100F	10	6-9/16	17-1/4	17-1/4	11-13/16	22-1/2	22-1/2	34-5/16	11-1/2	11-1/2	45.11
475-120	12	2-11/16	16-1/8	16-7/32	8-3/4	22-7/32	22-9/32	31-1/32	13-21/32	13-21/32	41.85
475-120F	12	7-5/16	20-1/16	20-1/16	13-9/16	26-5/16	26-5/16	39-7/8	13-9/16	13-9/16	63.02
475-140F	14	7-3/16	21-3/16	21-3/16	14-3/16	28-3/16	28-3/16	42-3/8	14-7/8	14-7/8	90.24
475-160F	16	8-3/4	24-3/4	24-3/4	16-3/4	32-3/4	32-3/4	49-1/2	17	17	93.06
475-180F	18	9-7/16	27-7/16	27-7/16	18-7/16	36-7/16	36-7/16	54-7/8	19-1/8	19-1/8	151.20
475-200F	20	11-7/16	30-5/16	30-5/16	21-7/16	40-5/16	40-5/16	61-3/4	21-3/16	21-3/16	191.78
475-240F	24	11	35	35	23	47	47	70	25-3/8	25-3/8	420.00

<sup>1</sup> Outlet sized with bushing

# PVC WHITE SCHEDULE 40 FITTINGS UNIONS & SADDLES



## REDUCING WYE

Socket x Socket x Socket

Pressure Rating  
 1/2" -2" 235 psi @ 73°F  
 2-1/2" -6" 150 psi @ 73°F  
 8" & Up 100 psi @ 73°F

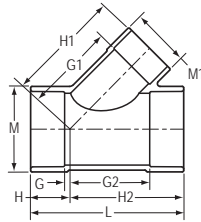

Part Number	Size	G	G1	G2	H	H1	H2	L	M	M1	Approx. Wt. (Lbs.)
475-101 <sup>1</sup>	3/4x3/4x1/2	5/16	2-5/32	1-3/8	1-5/16	2-15/16	2-3/8	3-11/16	1-3/8	1-3/8	.21
475-131 <sup>1</sup>	1x1x3/4	11/32	2	1-3/4	1-15/32	3-9/32	2-7/8	4-11/32	1-23/32	1-23/32	.36
475-167 <sup>1</sup>	1-1/4x1-1/4x3/4	3/8	2-3/4	2-1/4	1-5/8	3-3/4	3-1/2	5-1/8	2-1/16	2-1/16	.63
475-168 <sup>1</sup>	1-1/4x1-1/4x1	3/8	2-5/8	2-1/4	1-5/8	3-3/4	3-1/2	5-1/8	2-1/16	2-1/16	.58
475-210 <sup>1</sup>	1-1/2x1-1/2x3/4	1/2	3-1/2	2-9/16	1-7/8	4-1/2	3-15/16	5-13/16	2-11/32	2-11/32	.82
475-211 <sup>1</sup>	1-1/2x1-1/2x1	1/2	3	2-9/16	1-7/8	4-5/32	3-15/16	5-13/16	2-11/32	2-11/32	.84
475-212 <sup>1</sup>	1-1/2x1-1/2x1-1/4	1/2	3-1/4	2-9/16	1-7/8	4-1/2	3-15/16	5-13/16	2-11/32	2-11/32	.77
475-248 <sup>1</sup>	2x2x3/4	5/8	4-1/4	3-1/4	2-1/8	5-1/8	4-3/4	6-7/8	2-7/8	2-7/8	1.41
475-249 <sup>1</sup>	2x2x1	15/32	4-3/32	3-11/32	2	5-1/8	4-7/8	6-7/8	2-7/8	2-7/8	1.38
475-251 <sup>1</sup>	2x2x1-1/2	19/32	3-7/16	3-7/32	2-1/8	4-7/8	4-3/4	6-7/8	2-7/8	2-7/8	1.35
475-292 <sup>1</sup>	2-1/2x2-1/2x2	1	5-9/16	4-1/2	3	6-15/16	6-1/2	9-9/16	4-3/16	4-3/16	4.00
475-335 <sup>1</sup>	3x3x1	11/16	5-7/8	4-7/32	2-9/16	6-15/16	6-1/8	8-23/32	4-3/16	4-3/16	3.14
475-336 <sup>1</sup>	3x3x1-1/4	7/8	5-3/4	4-1/8	2-3/4	7	6	8-3/4	4-3/16	4-3/16	3.06
475-337 <sup>1</sup>	3x3x1-1/2	13/16	5-5/8	4-1/8	2-11/16	6-15/16	6	8-11/16	4-3/16	4-3/16	3.19
475-338 <sup>1</sup>	3x3x2	3/4	5-9/16	4-1/4	2-5/8	6-15/16	6-1/8	8-3/4	4-3/16	4-3/16	3.19
475-339 <sup>1</sup>	3x3x2-1/2	7/8	4-1/8	4-21/32	2-3/4	6-3/4	6	8-3/4	4-3/16	4-3/16	2.59
475-420	4x4x2	-5/16	4-11/16	4	2	6-7/32	6-5/16	8-5/16	5-9/32	2-29/32	2.78
475-422 <sup>1</sup>	4x4x3	5/8	6-7/8	5-5/8	2-7/8	8-7/8	7-7/8	10-3/4	5-1/4	5-1/4	6.00
475-528 <sup>1</sup>	6x6x2	1/16	8-5/8	6-5/8	3	10	6-11/16	12-11/16	7-9/16	4-3/4	9.30
475-530 <sup>1</sup>	6x6x3	1/32	8-1/4	6-21/32	3-1/32	10-1/4	9-21/32	12-11/16	7-9/16	5-7/16	9.29
475-532	6x6x4	31/32	6-9/16	5-11/16	3-15/16	8-27/32	8-23/32	21-21/32	7-9/16	5-7/16	8.61
475-532F	6x6x4	2-9/16	10-9/16	9-3/16	5-13/16	12-3/16	12-7/16	18-1/4	7-3/16	5	6.71
475-578F	8x8x2	9/16	9-3/4	9-3/16	4-13/16	11-1/2	13-7/16	18-1/4	9-1/4	2-11/16	12.62
475-580F	8x8x3	1-5/16	10-7/8	9-15/16	5-9/16	13-1/8	14-3/16	19-3/4	9-1/4	3-15/16	14.36
475-582F	8x8x4	2-1/16	11-7/8	10-11/16	6-5/16	14-1/8	14-15/16	21-1/4	9-1/4	5	16.32
475-585F	8x8x6	3-1/2	12-13/16	12-1/8	7-3/4	16-1/16	16-3/8	24-1/8	9-1/4	7-3/16	19.47
475-621F	10x10x2	1/2	11-3/16	10-1/4	4-3/4	12-15/16	15-1/2	20-1/4	11-1/2	2-11/16	17.95
475-623F	10x10x3	1/2	12-5/16	11-1/4	5-3/4	14-9/16	16-1/2	22-1/4	11-1/2	3-15/16	18.96
475-624F	10x10x4	1-7/16	13-5/16	12-3/16	6-11/16	15-9/16	17-7/16	24-1/8	11-1/2	5	22.97
475-626	10x10x6	-9/32	12-27/32	11-1/32	4-23/32	15-7/8	16-1/32	20-3/4	12-1/32	7-19/32	28.18

<sup>1</sup> Outlet sized with bushing



# PVC WHITE SCHEDULE 40 FITTINGS UNIONS & SADDLES

## REDUCING WYE

Socket x Socket x Socket

(continued)

Pressure Rating  
 1/2" -2" 235 psi @ 73°F  
 2-1/2" -6" 150 psi @ 73°F  
 8" & Up 100 psi @ 73°F

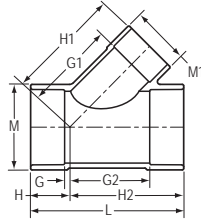

Part Number	Size	G	G1	G2	H	H1	H2	L	M	M1	Approx. Wt. (Lbs.)
475-626F	10x10x6	3-1/2	14-1/4	14-1/4	8-3/4	17-1/2	19-1/2	28-1/4	11-1/2	7-3/16	21.45
475-628	10x10x8	1-7/32	12-3/4	12-1/4	6-7/32	16-25/32	17-9/32	23-1/2	12-1/32	9-23/32	35.50
475-628F	10x10x8	5-1/8	15-11/16	15-7/8	10-3/8	19-15/16	21-1/8	31-1/2	11-1/2	9-1/4	28.02
475-661F	12x12x2	1-1/8	12-9/16	11-5/8	5-1/8	14-5/16	17-7/8	23	13-9/16	2-11/16	40.46
475-663F	12x12x3	3/8	13-11/16	12-3/8	5-7/8	15-15/16	18-5/8	24-1/2	13-9/16	3-15/16	28.74
475-664F	12x12x4	3/8	14-11/16	13-1/8	6-5/8	16-15/16	19-3/8	26	13-9/16	5	23.93
475-666F	12x12x6	2-3/8	15-5/8	15-1/8	8-5/8	18-7/8	21-3/8	30	13-9/16	7-3/16	28.92
475-668F	12x12x8	3-7/8	17-1/16	16-5/8	10-1/8	21-5/16	22-7/8	33	13-9/16	9-1/4	45.53
475-670F	12x12x10	5-3/8	18-1/8	18-1/8	11-5/8	23-3/8	24-3/8	36	13-9/16	11-1/2	40.69
475-691F	14x14x2	2	13-7/16	12	5	15-3/16	19	24	14-7/8	2-11/16	29.36
475-693F	14x14x3	3/4	14-9/16	13-1/4	6-1/4	16-13/16	20-1/4	26-1/2	14-7/8	3-15/16	33.06
475-694F	14x14x4	0	15-9/16	14	7	17-13/16	21	28	14-7/8	5	37.45
475-696F	14x14x6	1-1/2	16-1/2	15-1/2	8-1/2	19-3/4	22-1/2	31	14-7/8	7-3/16	48.96
475-698F	14x14x8	3	17-15/16	17	10	22-3/16	24	34	14-7/8	9-1/8	48.96
475-700F	14x14x10	4-1/2	19	18-1/2	11-1/2	24-1/4	25-1/2	37	14-7/8	11-1/2	60.73
475-702F	14x14x12	7	20-15/16	21	14	27-3/16	28	42	14-7/8	13-9/16	69.34
475-751F	16x16x2	2	14-3/4	14	6	16-1/2	22	28	17	2-11/16	37.81
475-753F	16x16x3	1-1/8	15-7/8	14-7/8	6-7/8	18-1/8	22-7/8	29-3/4	17	3-15/16	40.93
475-754F	16x16x4	1/2	16-7/8	15-1/2	7-1/2	19-1/8	23-1/2	31	17	5	50.95
475-756F	16x16x6	1-7/8	17-13/16	17-7/8	9-7/8	21-1/16	25-7/8	35-3/4	17	7-3/16	60.24
475-758F	16x16x8	2-1/2	19-1/4	18-1/2	10-1/2	23-1/2	26-1/2	37	17	9-1/4	70.40
475-760F	16x16x10	4	20-5/16	20	12	25-9/16	28	40	17	11-1/2	73.02
475-762F	16x16x12	5-1/2	22-1/4	21-1/2	13-1/2	28-1/2	29-1/2	43	17	13-9/16	90.59
475-764F	16x16x14	6-3/8	22-1/2	22-3/8	14-3/8	29-1/2	30-3/8	44-3/4	17	14-7/8	100.41
475-786F	18x18x6	7/8	19-1/8	18-7/8	9-7/8	22-3/8	27-7/8	37-3/4	19-1/8	7-3/16	81.78
475-788F	18x18x8	2-3/8	20-9/16	20-3/8	11-3/8	24-13/16	29-3/8	40-3/4	19-1/8	9-1/4	101.85
475-790F	18x18x10	3-3/8	21-5/8	21-3/8	12-3/8	26-7/8	30-3/8	42-3/4	19-1/8	11-1/2	83.99
475-792F	18x18x12	4-7/8	23-9/16	22-7/8	13-7/8	29-13/16	31-7/8	45-3/4	19-1/8	13-9/16	92.98
475-794F	18x18x14	5-3/8	23-13/16	23-3/8	14-3/8	30-13/16	32-3/8	46-3/4	19-1/8	14-7/8	116.88
475-796F	18x18x16	7-7/8	26-1/16	25-7/8	16-7/8	34-1/16	34-7/8	51-3/4	19-1/8	17	121.63
475-816F	20x20x6	1/8	20-1/2	19-7/8	9-7/8	23-3/4	29-7/8	39-3/4	21-3/16	7-3/16	101.52
475-818F	20x20x8	1-3/8	21-15/16	21-3/8	11-3/8	26-3/16	31-3/8	42-3/4	21-3/16	9-1/4	109.36
475-820F	20x20x10	2-3/8	23	22-3/8	12-3/8	28-1/4	32-3/8	44-3/4	21-3/16	11-1/2	120.53
475-822F	20x20x12	4-3/8	24-15/16	24-3/8	14-3/8	31-3/16	34-3/8	48-3/4	21-3/16	13-9/16	135.66
475-824F	20x20x14	4-7/8	25-3/16	24-7/8	14-7/8	32-3/16	34-7/8	49-3/4	21-3/16	14-7/8	129.00

# PVC WHITE SCHEDULE 40 FITTINGS UNIONS & SADDLES



## REDUCING WYE

Socket x Socket x Socket

(continued)

Pressure Rating  
 1/2" -2" 235 psi @ 73°F  
 2-1/2" -6" 150 psi @ 73°F  
 8" & Up 100 psi @ 73°F

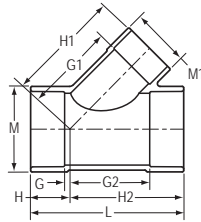

Part Number	Size	G	G1	G2	H	H1	H2	L	M	M1	Approx. Wt. (Lbs.)
475-826F	20x20x16	6-3/8	27-7/16	26-3/8	16-3/8	35-7/16	36-3/8	52-3/4	21-3/16	17	161.54
475-828F	20x20x18	7-7/8	28-13/16	27-7/8	17-7/8	37-13/16	37-7/8	55-3/4	21-3/16	19-1/8	158.46
475-906F	24x24x6	1-1/4	23-3/16	22-3/4	10-3/4	26-7/16	34-3/4	45-1/2	25-3/8	7-3/16	135.24
475-908F	24x24x8	1/4	24-5/8	24-1/4	12-1/4	28-7/8	36-1/4	48-1/2	25-3/8	9-1/4	145.74
475-910F	24x24x10	1-3/8	25-11/16	25-3/8	13-3/8	30-15/16	37-3/8	50-3/4	25-3/8	11-1/2	176.10
475-912F	24x24x12	3-1/4	27-5/8	27-1/4	15-1/4	33-7/8	39-1/4	54-1/2	25-3/8	13-9/16	153.58
475-914F	24x24x14	4	27-7/8	28	16	34-7/8	40	56	25-3/8	14-7/8	184.50
475-916F	24x24x16	6-3/8	30-1/8	30-3/8	18-3/8	38-1/8	42-3/8	60-3/4	25-3/8	17	185.70
475-918F	24x24x18	7-7/8	31-1/2	31-7/8	19-7/8	40-1/2	43-7/8	63-3/4	25-3/8	19-1/8	185.70
475-920F	24x24x20	9-1/8	33	33-1/8	21-1/8	43	45-1/8	66-1/4	25-3/8	21-3/16	232.49

## DOUBLE WYE

Socket x Socket x Socket x Socket

Pressure Rating  
 150 psi @ 73°F

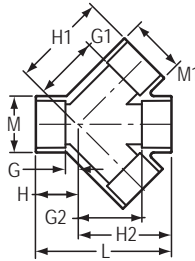

Part Number	Size	G	G1	G2	H	H1	H2	L	M	M1	Approx. Wt. (Lbs.)
476-020F	2	3-5/16	5-11/16	5-11/16	4-11/16	7-1/16	7-1/16	11-3/4	2-3/4	2-3/4	1.25
476-030F	3	4-7/8	8-3/8	8-3/8	6-3/4	10-1/14	10-1/4	17	4	4	5.42
476-040F	4	4-5/8	9-1/8	9-1/8	6-7/8	11-3/8	11-3/8	18-5/16	5	5	10.09
476-060F	6	4-7/8	11-1/2	11-1/2	8-1/8	14-3/4	14-3/4	22-7/8	7-3/16	7-3/16	20.91
476-080F	8	5-5/8	14-5/16	14-5/16	9-7/8	18-9/16	18-9/16	28-7/16	9-1/4	9-1/4	25.02
476-100F	10	6-9/16	17-1/4	17-1/4	11-13/16	22-1/2	22-1/2	34-5/16	11-1/2	11-1/2	37.91
476-120F	12	7-5/16	20-1/16	20-1/16	13-9/16	26-5/16	26-5/16	39-7/8	13-9/16	13-9/16	63.02
476-140F	14	7-3/16	21-3/16	21-3/16	14-3/16	28-3/16	28-3/16	42-3/8	14-7/8	14-7/8	96.09



# PVC WHITE SCHEDULE 40 FITTINGS UNIONS & SADDLES

## REDUCING DOUBLE WYE

Socket x Socket x Socket x Socket

Pressure Rating  
150 psi @ 73°F

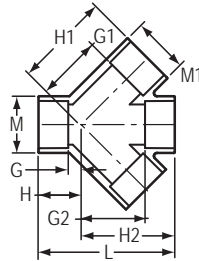

Part Number	Size	G	G1	G2	H	H1	H2	L	M	M1	Approx. Wt. (Lbs.)
476-338	3x2	7/32	4-1/4	4-1/32	2-3/32	5-3/4	5-29/32	8	4-3/16	2-7/8	2.27
476-528F	6x2	7/8	8-7/16	7-1/2	4-1/8	10-3/16	10-3/4	14-7/8	7-3/16	2-11/16	5.87
476-530F	6x3	1-13/16	9-9/16	8-7/16	5-1/16	11-13/16	11-11/16	16-3/4	7-3/16	3-15/16	10.29
476-532F	6x4	2-9/16	10-9/16	9-3/16	5-13/16	12-13/16	12-7/16	18-1/4	7-3/16	5	9.52
476-578F	8x2	9/16	9-3/4	9-3/16	4-13/16	11-1/2	13-7/16	18-1/4	9-1/4	2-11/16	12.49
476-580F	8x3	1-5/16	10-7/8	9-15/16	5-9/16	13-1/8	14-3/16	19-3/4	9-1/4	3-15/16	15.79
476-582F	8x4	2-1/16	11-7/8	10-11/16	6-5/16	14-1/8	14-15/16	21-1/4	9-1/4	5	12.73
476-585F	8x6	3-1/2	12-13/16	12-1/8	7-3/4	16-1/16	16-3/8	24-1/8	9-1/4	7-3/16	24.52
476-621F	10x2	1/2	11-3/16	10-1/4	4-3/4	12-15/16	15-1/2	20-1/4	11-1/2	2-11/16	13.93
476-623F	10x3	1/2	12-5/16	11-1/4	5-3/4	14-9/16	16-1/2	22-1/4	11-1/2	3-15/16	16.31
476-624F	10x4	1-7/16	13-5/16	12-3/16	6-11/16	15-9/16	17-7/16	24-1/8	11-1/2	5	18.71
476-626F	10x6	3-1/2	14-1/4	14-1/4	8-3/4	17-1/2	19-1/2	28-1/4	11-1/2	7-3/16	24.65
476-628F	10x8	5-1/8	15-11/16	15-7/8	10-3/8	19-15/16	21-1/8	31-1/2	11-1/2	9-1/4	31.59
476-661F	12x2	1-1/8	12-9/16	11-5/8	5-1/8	14-5/16	17-7/8	23	13-9/16	2-11/16	32.18
476-663F	12x3	3/8	13-11/16	12-3/8	5-7/8	15-15/16	18-5/8	24-1/2	13-9/16	3-15/16	35.93
476-664F	12x4	3/8	14-11/16	13-1/8	6-5/8	16-15/16	19-3/8	26	13-9/16	5	25.49
476-666F	12x6	2-3/8	15-5/8	15-1/8	8-5/8	18-7/8	21-3/8	30	13-9/16	7-3/16	42.56
476-668F	12x8	3-7/8	17-1/16	16-5/8	10-1/8	21-5/16	22-7/8	33	13-9/16	9-1/4	37.86
476-670F	12x10	5-3/8	18-1/8	18-1/8	11-5/8	23-3/8	24-3/8	36	13-9/16	11-1/2	67.89
476-756F	16x6	1-7/8	17-13/16	17-7/8	9-7/8	21-1/16	25-7/8	35-3/4	17	7-3/16	64.27
476-786F	18x6	7/8	19-1/8	18-7/8	9-7/8	22-3/8	27-7/8	37-3/4	19-1/8	7-3/16	91.45



# PVC WHITE SCHEDULE 40 FITTINGS UNIONS & SADDLES



## TANK ADAPTER WITH EPDM GASKET

Socket (Male Pipe Thread)

Pressure Rating  
150 psi @ 73°F

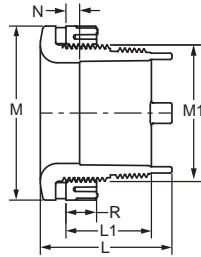

Part Number	Size	L	L1	M	M1	N	R
4170E-005	1/2	2-5/16	1-1/2	2-3/16	1-7/16	3/4	9/16
4170E-007	3/4	2-3/8	1-1/2	2-1/2	1-13/16	9/16	9/16
4170E-010	1	2-3/8	1-1/2	2-3/4	2-1/16	1/2	9/16
4170E-012	1-1/4	2-3/8	1-9/16	3-3/16	2-1/2	5/16	9/16
4170E-015	1-1/2	2-3/8	1-9/16	3-3/16	2-1/2	1/4	9/16
4170E-020	2	3-1/4	2-3/8	3-13/16	3-1/16	1	5/8
4170E-025	2-1/2	3-1/2	2-9/16	4-1/2	3-11/16	13/16	5/8

### Tank Adapter Hole Size Requirements

Tank Adapter Size	Recommended Minimum Hole Size	Minimum Inside Curvature Radius (inches)	Maximum Tank Wall Thickness (inches)
1/2	1-1/2	5.50	.44
3/4	1-7/8	7.50	.44
1	2-1/8	9.00	.44
1-1/4	2-1/2	12.00	.44
1-1/2	2-1/2	12.00	.44
2	3-1/8	17.50	.75
2-1/2	3-3/4	24.50	.88