



# Waste

## BRUTE® UTILITY

Mega BRUTE® Mobile Waste Collector.....	5
Nothing Beats a BRUTE®.....	6
BRUTE® 44-Gallon Utility Container.....	7
BRUTE® Round Containers.....	8
BRUTE® Dollies.....	9
BRUTE® Rim Caddy.....	10
BRUTE® Square Containers.....	11
BRUTE® Rollout Containers.....	11

## INDOOR UTILITY

Slim Jim® Containers.....	12
Slim Jim® Tops, Combo, & Trolley.....	13
Slim Jim® Wall Mounted Containers.....	13
Step-On Containers.....	14
Hands-Free Pedal Rolltop Containers.....	14
Untouchable® Containers and Tops.....	15
Soft Wastebaskets and Untouchable® Tops...16	
Fire Resistant Wastebaskets.....	16
Rigid Liners.....	17
Atrium® Classic Containers.....	17

## DECORATIVE PLASTIC CONTAINERS

Marshal® Classic Containers.....	18
----------------------------------	----

Glutton® Containers.....	18
Ranger® Classic Containers.....	18
Plaza® Containers.....	19

## DECORATIVE METAL CONTAINERS

Infinity™ Decorative Waste Containers.....	20
Square Containers.....	20
Round Containers.....	20
Infinity™ 3-Step Ordering Process.....	21
Landmark Series® Classic Containers.....	22
Landmark Series® Steel Containers.....	23
Landmark Series® Security Containers.....	23
WeatherGard® Series Containers.....	24
Atrium® Aluminum Containers.....	24
Marshal® Steel Containers.....	25
Atrium® Steel Containers.....	25

## DECORATIVE FIBERGLASS CONTAINERS

Ranger® Fiberglass Containers.....	26
Atrium® Fiberglass Containers.....	26

## CONFIDENTIAL WASTE

Confidential Waste Containers.....	27
------------------------------------	----

## SMOKING MANAGEMENT

Infinity™ Smoking Management Solutions ...28	
--	--

GroundsKeeper® Smoking Management Receptacles.....	29
Ash/Trash Containers.....	30
Classic Smoking Urns and Accessories.....	30

## GAS STATION/STORE FRONT CONTAINERS

Landmark Series® Gas Station/Store Front Containers.....	31
--	----

## MEDICAL WASTE

Medical Waste Step-On Containers.....	32
BRUTE® Square Container with Snap-Lock® Lid.....	32
BRUTE® Medical Waste Rollout Containers....	32

## RECYCLE WASTE

Recycling Solutions.....	33
Outdoor Station Containers.....	33
Recycling Boxes.....	33
Deskside Recycling Containers.....	34
Indoor Station Containers and Tops.....	34
Mobile Collection Equipment.....	35

## CAN LINERS

Can Liners.....	36
-----------------	----

## 4 WASTE: Mega BRUTE®



### OPTIMIZE WASTE SORTATION

Increase efficiency and support recycling efforts with Mega BRUTE®.

- Metal bag retainers securely hold a 55-gallon can liner
- Optional 23-gallon Slim Jim® container fits snugly within Mega BRUTE®

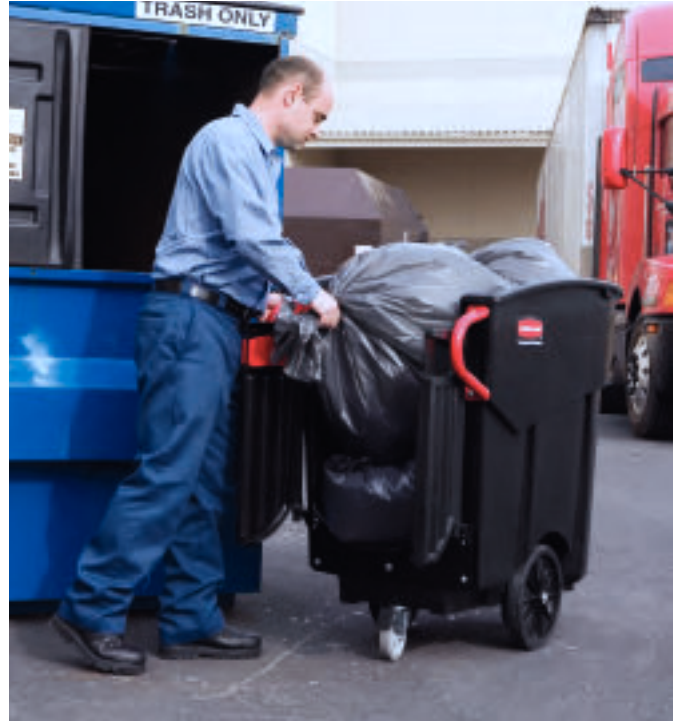

### BOOST COLLECTION EFFICIENCY

Save time and money by reducing trips to empty collected waste.

- Fill and transport multiple can liners
- Rear doors ease handling of heavy filled liners



### TRANSPORT LARGE LOADS

Use Mega BRUTE® for high-capacity collection of waste throughout a facility.

- Holds up to 120 gallons (approximately four filled 55-gallon liners)
- Safely transports up to 400 pounds
- Can liner retainer flips up and out of the way

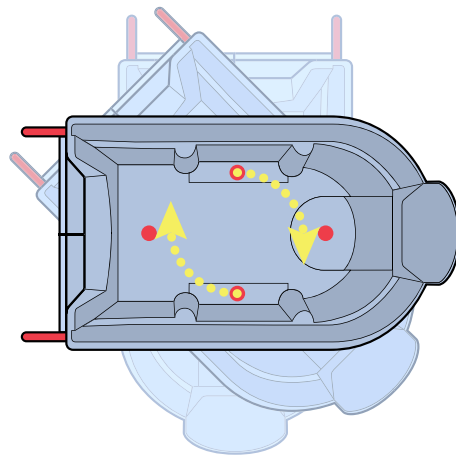

### SUPERIOR MANEUVERABILITY

Large 12" wheels and 5" lockable non-marking swivel casters, mounted in a "diamond" pattern, allow 360° rotation for moving in tight spaces.

- Fits through a standard 36" doorway
- Travels easily on and off most elevators

## Color Guide

See Product Description for Color Availability



Black  
BLA

**Mega BRUTE® Mobile Waste Collector** *New!*

Mega BRUTE® Mobile Waste Collector is a highly maneuverable and versatile waste collection and sortation system. Innovative design features deliver improved productivity and ease of use.

- High capacity
- Waste sortation
- Ergonomic rear doors
- Highly maneuverable

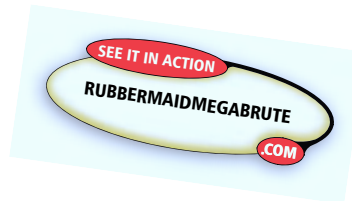

**SORTATION OPTIONS**  
 Holds an optional 23-gallon Slim Jim® container for improved waste sortation and recycling.

**STORAGE AREA**  
 Ideal for storing extra can liners and other cleaning supplies.



**CAN LINER RETAINER**  
 Secures a 55-gallon can liner and flips up for easy access to waste storage area.



Rear doors allow easy liner removal from the back of Mega BRUTE®.

**EASILY MANEUVERABLE**  
 Large 12" wheels and 5" non-marking lockable casters in a diamond pattern allow Mega BRUTE® to turn on its own axis.



Optional lid fully covers waste and supplies; center hinge allows access to either end of Mega BRUTE®.

**MEGA BRUTE® MOBILE WASTE COLLECTOR**

No.	Description	U.S. Dimensions	U.S. Capacity	U.S. Ship Wt/Ctn	Metric Dimensions	Metric Capacity	Metric Ship Wt/Ctn	Color	Pack	**US List Price
9W71	Mega BRUTE® Mobile Waste Collector, 3 pk	52½" l x 27½" w x 42½" h	120 gal	222 lb	133.3 cm x 69.9 cm x 108 cm	454.3 L	100.7 kg	BLA	3	510.00
9W73	Mega BRUTE® Mobile Waste Collector, 1 pk	52½" l x 27½" w x 42½" h	120 gal	74 lb	133.3 cm x 69.9 cm x 108 cm	454.3 L	100.7 kg	BLA	1	561.00
9W72	Mega BRUTE® Lid	49½" l x 30" w x 10½" h	-	12.4 lb	125.7 cm x 76.2 cm x 26.7 cm	-	5.6 kg	BLA	1	180.00

# 6 WASTE: BRUTE® Utility

## Nothing Beats a BRUTE®

BRUTE® Utility Containers are the industry leader in waste and material handling.

### FOR DURABILITY

BRUTE® is built tough to survive rough handling and rugged environments.

- Double-ribbed bases increase stability and dragging capacity
- Reinforced rims add strength and durability
- Heavy-duty handles provide non-slip lifting and carrying of heavy loads
- Tight-fitting lids protect contents and keep waste where it belongs

### FOR VERSATILITY

With a choice of colors in sizes from 10 to 55 gallons, and lids and tops for a variety of uses, there's a BRUTE® for every application.

- BRUTE® containers meet industry regulations and criteria for safe, efficient waste and material handling
- Containers are stackable or nestable for efficient storage
- Both round and square BRUTE® containers fit all BRUTE® dollies for more productive waste collection and transportation (20 gallons and above)
- Custom imprinting is available on all BRUTE® containers



## Food Safety

The National Sanitation Foundation, an independent testing lab/organization, lists BRUTE® containers as meeting their criteria for cleanability and sanitation (Standards #2 and #21).

NSF

### BRUTE® BEATS THE COMPETITION IN DURABILITY DRAG TEST

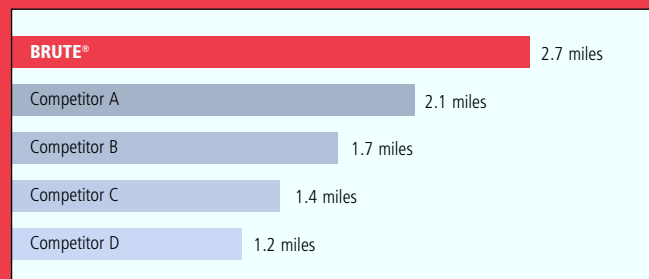

### FOOD SAFETY

Use BRUTE® containers with the assurance that they meet NSF regulations #2 and #21, and are USDA Meat and Poultry Equipment Group Listed (see page 8).



### FIRE SAFETY

Add a BRUTE® Dome Top Lid to a BRUTE® 32-, 44-, and 55-gallon container to meet the approval standards of the CSFM, the most stringent fire code in the United States (see page 8).

### MEDICAL WASTE COLLECTION & DISPOSAL

Use for central medical waste collection and disposal or in high volume generation areas, such as operating rooms (see page 31).

## Color Guide

See Product Description for Color Availability

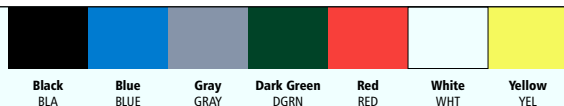

**BRUTE® 44-Gallon Utility Container**

**New!**

The new BRUTE® Utility Container features innovative solutions for making waste collection more efficient—along with the quality, durability, and superior performance found in every BRUTE® product.

- Integrated, patent-pending venting channels
- Patent-pending can liner cinches
- Improved ProTouch™ handles
- Can be used with the full line of BRUTE® accessories



**VENTING CHANNELS**  
Four patent-pending venting channels dramatically reduce the force required to remove a filled can liner by over 50%\* compared to traditional containers.

\*Based on internal testing.



All BRUTE® dollies, caddies, and other products and accessories fit the new BRUTE® 44-gallon container.

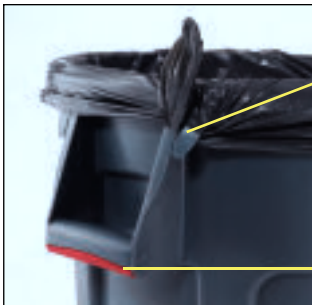

- Four patent-pending can liner cinches allow easy one-step bag retention and eliminate knot tying.
- ProTouch™ handles provide a fully rounded, comfortable grip.



2645-60 / 2643-60  
Optional self-draining lid prevents pooling when containers are stored outside.

No.	Description	U.S. Dimensions	U.S. Capacity	U.S. Ship Wt/Ctn	Metric Dimensions	Metric Capacity	Metric Ship Wt/Ctn	Can Liners	Color	Pack	**U.S. List Price
2643-60	BRUTE® Container	24" dia x 31½" h	44 gal	49.5 lb	61 cm x 80 cm	166.5 L	22.4 kg		GRAY, BLA, YEL, BLUE	4	67.60
2645-60	BRUTE® Lid	24.5" dia x 1½" h	-	10.4 lb	62.2 cm x 3.8 cm	-	4.7 kg		BLA, GRAY, DGRN, RED, WHIT, YEL	1	24.70



# 8 WASTE: BRUTE® Utility

## BRUTE® Round Containers

Durable, heavy-duty containers for a variety of uses.

- All-plastic, professional-grade construction will not rust, chip, or peel and resists dents
- Strong, snap-on lids provide secure, stable stacking
- Gray, white, and yellow are USDA Meat & Poultry Equipment Group Listed and assist in complying with HACCP guidelines
- Certified to NSF Standard #2 (blue, gray, white, and yellow) and Standard #21
- Product SKUs 2632/2637-88, 2643/2647-88, and 2655/2657-88 are CSFM approved when used as container/lid combo



Available in a wide variety of sizes and colors.

### BRUTE® ROUND CONTAINERS

No.	Description	U.S. Dimensions	U.S. Capacity	U.S. Ship Wt/Ctn	Metric Dimensions	Metric Capacity	Metric Ship Wt/Ctn	Can Liners	Color	Pack	**U.S. List Price
2610*	BRUTE® Container without Lid	15 $\frac{1}{2}$ " dia x 17 $\frac{1}{2}$ " h	10 gal	19 lb	39.7 cm x 43.5 cm	37.9 L	8.6 kg	5003-88*	GRAY, WHT	6	20.60
2620*	BRUTE® Container without Lid	19 $\frac{1}{2}$ " dia x 22 $\frac{1}{2}$ " h	20 gal	35 lb	49.5 cm x 58.1 cm	75.7 L	15.9 kg	5006-88*	BLUE, GRAY, WHT, YEL	6	32.20
2632**	BRUTE® Container without Lid	22" dia x 27 $\frac{1}{2}$ " h	32 gal	49.5 lb	55.9 cm x 69.2 cm	121.1 L	22.4 kg	5007-88*	BLUE, GRAY, DGRN, RED, WHT, YEL	6	41.00
2643**	BRUTE® Container without Lid	24" dia x 31 $\frac{1}{2}$ " h	44 gal	52.25 lb	61 cm x 80 cm	166.5 L	23.7 kg	5008-88*	BLUE, GRAY, DGRN, RED, WHT, YEL	4	64.00
2655**	BRUTE® Container without Lid	26 $\frac{1}{2}$ " dia x 33" h	55 gal	53 lb	67.3 cm x 83.8 cm	208.2 L	24 kg	5011-88*	GRAY	3	97.80

\* Custom imprinting available; contact Rubbermaid Customer Service at (800) 347-9800 for details.

\*\* CSFM approved when used as Container & Dome Top Lid Combo.

### BRUTE® FOOD PROCESSING CONTAINERS (BLACK IMPRINTED CONTAINERS WITHOUT LIDS)

No.	Description	U.S. Dimensions	U.S. Capacity	U.S. Ship Wt/Ctn	Metric Dimensions	Metric Capacity	Metric Ship Wt/Ctn	Can Liners	Color	Pack	**U.S. List Price
2632-46	with "USDA Condemned" Imprint English & Spanish	22" dia x 27 $\frac{1}{2}$ " h	32 gal	49.45 lb	55.9 cm x 69.2 cm	121.1 L	22.4 kg	5007-88*	YEL	6	41.00
2632-56	with "Inedible" Imprint English & Spanish	22" dia x 27 $\frac{1}{2}$ " h	32 gal	49.45 lb	55.9 cm x 69.2 cm	121.1 L	22.4 kg	5007-88*	GRAY	6	41.00
2643-46	with "USDA Condemned" Imprint English & Spanish	24" dia x 31 $\frac{1}{2}$ " h	44 gal	52.25 lb	61 cm x 80 cm	166.5 L	23.7 kg	5008-88*	YEL	4	64.00
2643-56	with "Inedible" Imprint English & Spanish	24" dia x 31 $\frac{1}{2}$ " h	44 gal	52.25 lb	61 cm x 80 cm	166.5 L	23.7 kg	5008-88*	GRAY	4	64.00

\* Not for sale in California.

**New!**



2631



2645-60



2637-88



2647-88



3543

### BRUTE® LIDS AND TOPS

No.	Description	U.S. Dimensions	U.S. Ship Wt/Ctn	Metric Dimensions	Metric Ship Wt/Ctn	Color	Pack	**U.S. List Price
2609	Lid for 2610	16" dia x 1" h	5.08 lb	40.6 cm x 2.5 cm	2.3 kg	GRAY, WHT	6	7.60
2619	Lid for 2620	19 $\frac{1}{2}$ " dia x 1 $\frac{1}{2}$ " h	9.175 lb	50.5 cm x 3.2 cm	4.2 kg	GRAY, WHT, YEL	6	9.20
2631	Lid for 2632	22 $\frac{1}{2}$ " dia x 1 $\frac{1}{2}$ " h	12.33 lb	56.5 cm x 3.5 cm	5.6 kg	GRAY, DGRN, RED, WHT, YEL	6	13.30
2645-60	Lid for 2643, 2643-60	24 $\frac{1}{2}$ " dia x 1 $\frac{1}{2}$ " h	13.07 lb	62.2 cm x 3.8 cm	5.9 kg	GRAY, DGRN, RED, WHT, YEL, BLA	4	24.70
2654	Lid for 2655	26 $\frac{1}{2}$ " dia x 2" h	12.46 lb	67.9 cm x 5.1 cm	5.7 kg	GRAY	3	33.00
2637-88*	BRUTE® Dome Top for 2632	22 $\frac{1}{2}$ " dia x 12 $\frac{1}{4}$ " h	11.1 lb	57.6 cm x 31.1 cm	5.0 kg	GRAY, RED	1	89.00
2647-88*	BRUTE® Dome Top for 2643	24 $\frac{1}{2}$ " dia x 12 $\frac{1}{2}$ " h	12.1 lb	63 cm x 32.1 cm	5.4 kg	GRAY, RED	1	92.80
2657-88*	BRUTE® Dome Top for 2655	27 $\frac{1}{2}$ " dia x 14 $\frac{1}{2}$ " h	14.1 lb	69.2 cm x 36.8 cm	6.4 kg	GRAY, RED	1	118.50
3543*	Funnel Top for 2632	22 $\frac{1}{2}$ " dia x 5" h	9.76 lb	56.8 cm x 12.7 cm	4.4 kg	GRAY	4	41.40

\* Provides hands-free product use.

\*\* CSFM approved when used as Container & Dome Top Lid Combo.

### Color Guide

See Product Description for Color Availability



## BRUTE® Dollies

### ROUND AND SQUARE DOLLIES

Easy mobility and maneuverability of heavy loads.

- Swivel casters offer better mobility through work areas
- Heavy-duty, long-lasting 3" casters (2640 only)
- Attach trash containers with easy twist-on/twist-off action

### BRUTE® QUIET DOLLY

Perfect for noise-sensitive environments.

- Precision engineering eliminates 88% of dolly noise
- Specifically designed for hospitals, nursing homes, offices, schools, and hospitality facilities
- Non-marking red quiet casters

### BRUTE® TRAINABLE DOLLY

For an improved recycling solution.

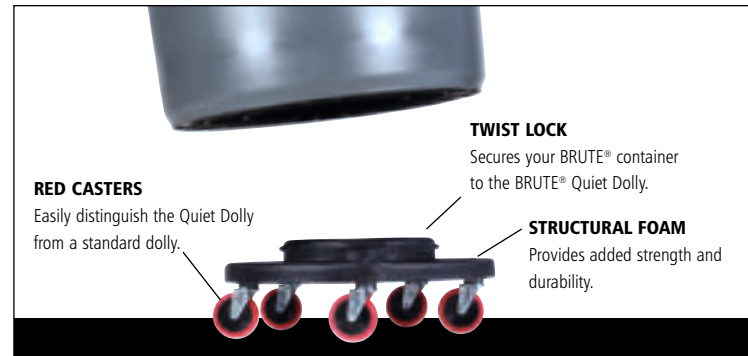

#### TILT STABILIZER

Provides an easy way to tilt BRUTE® containers for waste removal.



#### ADJUSTABLE PULL HANDLE CLIP

Pull Handle Accessory attaches to rim of 32-gallon, 44-gallon, or 55-gallon BRUTE® containers when not in use.



#### BALL AND HITCH FEATURE

Allows hands-free connection of up to three BRUTE® containers.



#### QUIET CASTERS

Reduces noise to allow daytime cleaning activities without workplace disruption.

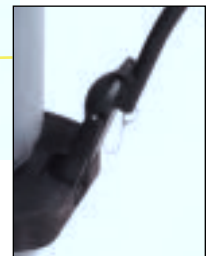

#### PULL HANDLE ACCESSORY

Easily connects to Trainable Dolly for increased control when transporting multiple BRUTE® containers.



2650



2651



2640-43



2640



2646



3530

No.	Description	U.S. Dimensions	U.S. Capacity	U.S. Ship Wt/Ctn	Metric Dimensions	Metric Capacity	Metric Ship Wt/Ctn	Color	Pack	**U.S. List Price
2640	BRUTE® Dolly for 2620, 2632, 2643, 2655 Containers	18 1/2" dia x 6 1/4" h	250 lb	13.1 lb	46.4 cm x 16.8 cm	113.3 kg	5.94 kg	BLA	2	66.20
2640-43	BRUTE® Quiet Dolly for 2620, 2632, 2643, 2655 Containers	18 1/2" dia x 6 1/4" h	250 lb	13.8 lb	46.4 cm x 16.8 cm	113.3 kg	6.26 kg	BLA	2	89.00
2650	Universal Drum Dolly for 2655 Container	24 1/2" dia x 7 1/2" h	500 lb	28.2 lb	61.9 cm x 18.1 cm	226.7 kg	12.8 kg	BLA	2	123.00
2646	BRUTE® Tandem Dolly for 2620, 2632, 2643, 2655, 3526, 3536 Containers	45" l x 20 1/2" w x 8" h	200 lb per platform	21 lb	114.3 cm x 51.4 cm x 20.3 cm	90.7 kg per platform	9.5 kg	BLA	1	168.50
3530	BRUTE® Square Dolly for 3526, 3536 Containers	17 1/2" sq x 6 1/2"	250 lb	18.5 lb	43.8 cm x 15.9 cm	113.3 kg	8.3 kg	BLA	2	77.20
2651	BRUTE® Trainable Dolly – 1 Pack	27 1/8" l x 20 3/8" w x 6 3/8" h	250 lb	12.6 lb	70.8 cm x 51.8 cm x 16.2 cm	113.3 kg	5.7 kg	BLA	1	110.50
2651-03	BRUTE® Trainable Dolly – 3 Pack	27 1/8" l x 20 3/8" w x 6 3/8" h	250 lb	35.6 lb	70.8 cm x 51.8 cm x 16.2 cm	113.3 kg	16.1 kg	BLA	3	326.00
2652	Pull Handle Accessory	34 1/2" l x 10 1/2" w x 1" h	N/A	5.75 lb	87.6 cm x 27.0 cm x 2.5 cm	N/A	2.6 kg	BLA	1	50.00

## BRUTE® Rim Caddy

Snaps securely onto the rim of BRUTE® 44-Gallon Containers (2643 and 2643-60).

- Provides storage and transport for spray bottles, wet-floor signs, lobby dust pan, brushes, liners, gloves, and other cleaning supplies\*
- Integrated bag straps allow for easy can liner attachment
- User-friendly handle improves maneuverability and minimizes contact with refuse
- Durable construction with smooth surfaces for easy cleaning

\*Tools and supplies sold separately.



Holds spray bottles, safety signs, and many other cleaning supplies.



Snap-on tabs keep caddy and accessories in place, even when removing a full liner.



9W87 Rim Caddy shown with 2643-60 BRUTE® 44 Gallon with patent-pending venting channels, 2640-43 Quiet Dolly, and other accessories sold separately.



Integrated can liner straps allow easy attachment and removal of can liners.



Efficiently dispense smaller liners from inside the BRUTE® container.



### CADDIES



### BRUTE® RIM CADDY

No.	Description	U.S. Dimensions	U.S. Ship Wt/Ctn	Metric Dimensions	Metric Ship Wt/Ctn	Color	Pack	**U.S. List Price
9W87	BRUTE® Rim Caddy 2641, 2643	32 1/2" l x 26 1/2" w x 6 1/2" h	4.92 lb	82.6 cm x 67.3 cm x 17.1 cm	2.23 kg	YEL	1	60.00

### CADDIES

No.	Description	U.S. Dimensions	U.S. Ship Wt/Ctn	Metric Dimensions	Metric Ship Wt/Ctn	Color	Pack	**U.S. List Price
2642	BRUTE® Caddy Bag for 2632, 2643, 2643-60 Containers	29" w x 20 1/2" h	11.305 lb	50.8 cm x 52.1 cm	5.1 kg	YEL	6	44.60
2649	Maid Caddy	16" l x 9" w x 5" h	6.50 lb	40.6 cm x 22.8 cm x 12.7 cm	2.9 kg	GRAY	4	29.00

### Color Guide

See Product Description for Color Availability



Blue BLUE    Gray GRAY    Red RED    Yellow YEL    White WHT



## BRUTE® Square Containers

Increased capacity for storage or refuse collection.

- Square shape offers up to 14% more capacity than round containers
- Tight-fitting lids help protect dry goods and other contents
- Nesting handles allow secure fit in side-by-side use
- Gray and white are USDA Meat & Poultry Equipment Group Listed and assist in complying with HACCP guidelines
- Certified to NSF Std. #2 (Gray and White) and Std. #21



3517

For additional medical products, see page 31.



3529/3526

No.	Description	U.S. Dimensions	U.S. Capacity	U.S. Ship Wt/Ctn	Metric Dimensions	Metric Capacity	Metric Ship Wt/Ctn	Can Liners	Color	Pack	**U.S. List Price
3517	Combo Pack with 3526 & 3529	21½" sq x 22¾" h	28 gal	74.57 lb	54.6 cm x 57.5 cm	106 L	33.8 kg	5016-88 <sup>a</sup>	RED	6	77.60
3526	Square BRUTE® Container without Lid	21½" sq x 22¾" h	28 gal	59.8 lb	54.6 cm x 57.2 cm	106 L	27.1 kg	5016-88 <sup>a</sup>	GRAY, RED, WHT	6	47.20
3536	Square BRUTE® Container without Lid	23½" sq x 28¾" h	40 gal	57.13 lb	59.7 cm x 73 cm	151.4 L	25.9 kg	5079, 5013-88 <sup>a</sup>	GRAY, WHT	4	67.00

<sup>a</sup> Not for sale in California.

### LIDS

No.	Description	U.S. Dimensions	U.S. Ship Wt/Ctn	Metric Dimensions	Metric Ship Wt/Ctn	Color	Pack	**U.S. List Price
3527	Lid for 3526 Container	22" sq x 2" h	16.8 lb	55.9 cm x 5.1 cm	7.6 kg	GRAY, RED, WHT	6	15.20
3529	Snap-Lock® Lid for 3526 Container	22" sq x 2¼" h	16.76 lb	55.9 cm x 5.4 cm	7.6 kg	RED	6	30.60
3539	Lid for 3536 Container	24" sq x 2" h	15.25 lb	61 cm x 5.1 cm	6.9 kg	GRAY, WHT	4	21.20

## BRUTE® Rollout Containers

### 50 GALLON

Easy mobility for general refuse collection and material handling.

- Heavy-duty 8" (20.3 cm) wheels provide easy mobility, even over steps or curbs
- Attached hinged lid fits tightly; swings back and locks
- Molded-in axle retainer adds strength
- Molded-in catch bar is compatible with automated lift systems
- Meets ANSI Z245.30-1999 for Types B and G Rollout Carts
- Inset wheel position helps prevent damage to walls and doorways



9W27

### 65 AND 95 GALLON

Efficient, large capacity waste collection.

- Ships fully assembled
- Steel catch bar is compatible with semi-automated lift systems
- Meets ANSI Z245.60-1999 for Types B and G Rollout Carts
- Stable in high winds and on uneven surfaces
- Inset wheel position helps prevent damage to walls and doorways
- Molded-in foot tilter helps maneuver heavy loads
- One-piece body construction provides superior strength and durability



9W21



9W22

No.	Description	U.S. Dimensions	U.S. Capacity	U.S. Ship Wt/Ctn	Metric Dimensions	Metric Capacity	Metric Ship Wt/Ctn	Color	Pack	**U.S. List Price
9W27	BRUTE® Rollout Container	29¾" l x 23¾" w x 46¾" h	50 gal	43.6 lb	73.7 cm x 60 cm x 93.3 cm	189.3L	19.8 kg	BLUE, GRAY, YEL	2	135.50
9W21	BRUTE® Rollout Container	32¾" l x 25¾" w x 41¾" h	65 gal	25.6 lb	82 cm x 64.3 cm x 106.2 cm	246.05 L	11.6 kg	BLUE, GRAY	1	214.00
9W22	BRUTE® Rollout Container	35¾" l x 27¾" w x 45¾" h	95 gal	36.0 lb	89.9 cm x 69.3 cm x 115 cm	359.6 L	16.3 kg	BLUE, GRAY	1	243.00

# 12 WASTE: Indoor Utility Containers

## Slim Jim® Containers

The industry standard in space-saving waste management.

- Efficient size and shape designed to fit in tight spaces
- Durable, all-plastic construction is easy to clean
- Handled versions make lifting and carrying easier
- Bottom hand-holds provide a secure grip during emptying



Available in multiple colors to simplify waste separation.

3540



3542-20



3541 with 2688-88 / 3540 with 2708-88



### MEGA BRUTE

See pages 4–5 for more information.

Slim Jim® containers are designed to work with a wide variety of Rubbermaid Commercial Products to make waste collection, recycling, cleaning, and material handling more efficient.



### CLEANING CARTS

See pages 62–64 for more information.

No.	Description	U.S. Dimensions	U.S. Capacity	U.S. Ship Wt/Ctn	Metric Dimensions	Metric Capacity	Metric Ship Wt/Ctn	Can Liners	Color	Pack	**U.S. List Price
3540*	Slim Jim® Waste Container	23 3/4" l x 11" w x 30" h	23 gal	32.9 lb	58.7 cm x 27.9 cm x 76.2 cm	87.1 L	14.9 kg	5009-88*	BEIG, BRN, BLA, BLUE, GRAY, YEL	4	60.20
3541	Slim Jim® Waste Container w/ handles	23 3/4" l x 11" w x 24 3/8" h	15 1/2 gal	34.7 lb	58.7 cm x 27.9 cm x 63.2 cm	60 L	15.7 kg	5009-88*	BEIG, DBLUE, LGRAY	4	45.60
3554*	Slim Jim® Waste Container w/ Handles	23 3/4" l x 11" w x 30" h	23 gal	35 lb	58.7 cm x 27.9 cm x 76.2 cm	87.1 L	15.9 kg	5009-88*	LGRAY	4	63.20

\* Custom imprinting available; contact Rubbermaid Customer Service at (800) 347-9800 for details.

^ Not for sale in California.

## Color Guide

See Product Description for Color Availability



Beige  
BEIG

Black  
BLA

Blue  
BLUE

Brown  
BRN

Dark Blue  
DBLUE

Gray  
GRAY

Green  
GRN

Light Gray  
LGRAY

Yellow  
YEL

## Slim Jim® Tops, Combo, & Trolley

Promote recycling and improve productivity.

### TOPS

- Encourage waste separation and recycling with interchangeable, color-coded tops: blue slotted top for paper; green or brown round-hole tops for bottles, jars, and cans; gray for general use
- Untouchable® Swing Top conceals waste from view
- Slim Jim® Combo includes 15-gallon Slim Jim® and Handle Top

### TROLLEY

- Link multiple Slim Jim® containers to reduce collection trips, or use trolley singly as a dolly
- Trolleys detach with a simple push on front toe plate



2673



2703-88 / 2688-88 / 2692-88

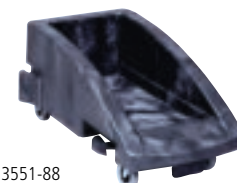

3551-88

### TOPS

No.	Description	U.S. Dimensions	U.S. Ship Wt/Ctn	Metric Dimensions	Metric Ship Wt/Ctn	Color	Pack	**U.S. List Price
2673	Slim Jim® Untouchable® Swing Top fits 3540, 3541, 3554 Containers	20 <sup>3/8</sup> " l x 11 <sup>1/8</sup> " w x 4 <sup>1/4</sup> " h	10.2 lb	51.8 cm x 28.9 cm x 12.1 cm	4.6 kg	BRN, BLUE, GRAY	4	37.80
2688-88	Slim Jim® Handle Top fits 3540, 3541, 3554 Containers	20 <sup>3/8</sup> " l x 11 <sup>1/8</sup> " w x 2 <sup>3/4</sup> " h	4.7 lb	51.8 cm x 28.7 cm x 7 cm	2.1 kg	LGRAY	4	38.80
2692-88	Slim Jim® Bottle & Can Recycling Top fits 3540, 3541, 3554 Containers	20 <sup>3/8</sup> " l x 11 <sup>1/8</sup> " w x 2 <sup>3/4</sup> " h	3.9 lb	51.8 cm x 28.7 cm x 7 cm	1.8 kg	BRN, GRN	4	38.80
2703-88	Slim Jim® Paper Recycling Top fits 3540, 3541, 3554 Containers	20 <sup>3/8</sup> " l x 11 <sup>1/8</sup> " w x 2 <sup>3/4</sup> " h	4.2 lb	51.8 cm x 28.7 cm x 7 cm	1.9 kg	BLUE	4	38.80

### COMBO

No.	Description	U.S. Ship Wt/Ctn	Metric Ship Wt/Ctn	Can Liners	Pack	**U.S. List Price
3542-20	Slim Jim® Combo: 3541 (1) Light Gray; 2688-88 (1) Light Gray	29.13 lb	13.2 kg	5009-88 <sup>a</sup>	4	82.40

<sup>a</sup> Not for sale in California.

### TROLLEY

No.	Description	U.S. Dimensions	U.S. Capacity	U.S. Ship Wt/Ctn	Metric Dimensions	Metric Capacity	Metric Ship Wt/Ctn	Color	Pack	**U.S. List Price
3551-88	Slim Jim® Trolley accommodates 3540, 3541, 3554 Containers	23 <sup>1/8</sup> " l x 15" w x 10 <sup>3/8</sup> " h	80 lb unhooked, total 120 lb 2, 3, or 4 hooked	20.80 lb	59.5 cm x 38.1 cm x 27.5 cm	36.3 kg unhooked, 9.43 kg total 54.4 kg 2, 3, or 4 hooked	9.43 kg	BLA	2	74.00

## Slim Jim® Wall Mounted Containers

Attractive design suits most decors.

- Wall mounting keeps the container out of pedestrian traffic and allows for floor cleaning
- Spring-loaded swing door helps control odor and hides trash from public view
- Comes with complete hardware and instructions for wall mounting
- California State Fire Marshal (CSFM) and Factory Mutual (FM) approved for fire safety when wall mounted; ideal for hallways and other uncontrolled public areas
- Slim design limits intrusion into corridors, washrooms, kitchens, and other environments where space is tight



CSFM ADA



7822

No.	Description	U.S. Dimensions	U.S. Capacity	U.S. Ship Wt/Ctn	Metric Dimensions	Metric Capacity	Metric Ship Wt/Ctn	Can Liners	Color	Pack	**U.S. List Price
7822	Slim Jim® Wall Mounted Container	19 <sup>1/2</sup> " l x 1 <sup>1/8</sup> " w x 32 <sup>3/8</sup> " h	15 gal	11.355 lb	49.5 cm x 30.2 cm x 82.9 cm	56.8 L	5.2 kg	5005-88 <sup>a</sup>	BRN, BEIG	1	152.50

<sup>a</sup> Not for sale in California.

# 14 WASTE: Indoor Utility Containers

## Step-On Containers

Provides sanitary waste management.

- Tight-fitting, overlapping lid helps contain odors
- Tough, puncture-resistant, all-plastic construction won't rust or chip
- Quiet, heavy-duty pedal for hands-free sanitary use
- Assists in complying with OSHA regulation 29 CFR 1910.1030 "Occupational Exposure to Bloodborne Pathogens"
- Optional rigid liners for 6143, 6144, 6145, and 6146 provide a leak-proof base



CSFM

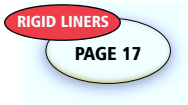

No.	Description	U.S. Dimensions	U.S. Capacity	U.S. Ship Wt/Ctn	Metric Dimensions	Metric Capacity	Metric Ship Wt/Ctn	Can Liners	Color	Pack	**U.S. List Price
6142	Step-On Can w/Rigid Liner	13 <sup>1/2</sup> " dia x 15 <sup>1/2</sup> " h	4 <sup>1/2</sup> gal	9.1 lb	33.7 cm x 39.1 cm	17 L	4.1 kg	5002-88 <sup>a</sup>	WHT	1	100.50
6143	Step-On Container	16 <sup>1/2</sup> " l x 15 <sup>1/2</sup> " w x 17 <sup>1/2</sup> " h	8 gal	7.9 lb	41.3 cm x 40 cm x 43.5 cm	30.3 L	3.6 kg	5004-88 <sup>a</sup>	BEIG, RED, WHT	1	101.50
6144	Step-On Container	16 <sup>1/2</sup> " l x 15 <sup>1/2</sup> " w x 23 <sup>1/2</sup> " h	12 gal	10 lb	41.3 cm x 40 cm x 60 cm	45.4 L	4.5 kg	5004-88 <sup>a</sup>	BEIG, RED, WHT	1	119.00
6145	Step-On Container	19 <sup>1/2</sup> " l x 16 <sup>1/2</sup> " w x 26 <sup>1/2</sup> " h	18 gal	13 lb	50.2 cm x 41 cm x 67.3 cm	68.1 L	5.9 kg	5009-88 <sup>a</sup>	BEIG, RED, WHT	1	135.50
6146	Mobile Step-On Container	19 <sup>1/2</sup> " l x 16 <sup>1/2</sup> " w x 32 <sup>1/2</sup> " h	23 gal	18 lb	50.2 cm x 41 cm x 82.6 cm	87.1 L	8.2 kg	5009-88 <sup>a</sup>	BEIG, RED, WHT	1	193.00

<sup>a</sup> Not for sale in California.

## Hands-Free Pedal Rolltop Containers

Slim oval shape fits easily in tight spaces.

- Rolltop lid opens without drawing odors into the air
- Wrap-around foot pedal is accessible from front and sides
- Slim shape fits under counters and out of the way



CSFM



6177



No.	Description	U.S. Dimensions	U.S. Capacity	U.S. Ship Wt/Ctn	Metric Dimensions	Metric Capacity	Metric Ship Wt/Ctn	Can Liners	Color	Pack	**U.S. List Price
6177	Pedal Rolltop Container	22 <sup>1/2</sup> " l x 14 <sup>1/2</sup> " w x 27 <sup>1/2</sup> " h	14 <sup>1/2</sup> gal	12 lb	56.5 cm x 37.3 cm x 69.1 cm	55 L	5.4 kg	5004-88 <sup>a</sup>	BEIG	1	103.00

<sup>a</sup> Not for sale in California.

## Color Guide

See Product Description for Color Availability

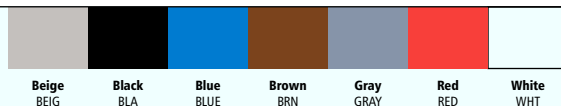

Beige  
BEIG

Black  
BLA

Blue  
BLUE

Brown  
BRN

Gray  
GRAY

Red  
RED

White  
WHT

## Untouchable® Containers and Tops

Available in round, half-round, and square shapes to fit every application.

- Durable and crack resistant, even under tough indoor/outdoor conditions
- Perfect for hotel lobbies, offices, restrooms, shopping malls, restaurants, and other public locations

Hygienic tops for attractive, hands-free waste disposal.

- Drop and swing lid design provides easy access and quickly returns to hide refuse from public view
- Controls litter, odors, and insects

RIGID LINERS  
PAGE 17



2689 / 3569



3548 / 3546



3620 / 3520



3958

ADA

No.	Description	U.S. Dimensions	U.S. Capacity	U.S. Ship Wt/Ctn	Metric Dimensions	Metric Capacity	Metric Ship Wt/Ctn	Can Liners	Color	Pack	**U.S. List Price
2947	Round Container	15½" dia x 18¾" h	44½ qt	15 lb	40 cm x 47.6 cm	42 L	6.8 kg	5003-88 <sup>a</sup>	GRAY	6	18.40
3520	Half Round Container	21" l x 11" w x 28" h	21 gal	30.11 lb	53.3 cm x 27.9 cm x 71.1 cm	79.5 L	13.7 kg	5005-88 <sup>a</sup>	BEIG, GRAY	4	81.40
3546	Round Container	15½" dia x 30¾" h	22 gal	27.6 lb	40 cm x 76.5 cm	83.3 L	12.5 kg	5004-88 <sup>a</sup>	BEIG, GRAY	4	59.20
3568	Square Container	14½" sq x 24" h	19 gal	24.93 lb	36.8 cm x 61 cm	71.9 L	11.3 kg	5005-88 <sup>a</sup>	BEIG, GRAY	4	63.60
3569	Square Container	14½" sq x 28" h	23 gal	29.34 lb	36.8 cm x 71.1 cm	87.1 L	13.3 kg	5005-88 <sup>a</sup>	BEIG, BRN, GRAY	4	67.00
3958	Square Container	19½" sq x 27¾" h	35 gal	39.425 lb	49.5 cm x 70.2 cm	132.5 L	17.9 kg	5008-88 <sup>a</sup>	BEIG, GRAY	4	108.00
3959	Square Container	19½" sq x 34¼" h	50 gal	53.89 lb	49.5 cm x 87 cm	189.3 L	24.4 kg	5008-88 <sup>a</sup>	BEIG, GRAY	4	150.00

<sup>a</sup> Not for sale in California.



### TOPS

No.	Description	U.S. Dimensions	U.S. Ship Wt/Ctn	Metric Dimensions	Metric Ship Wt/Ctn	Color	Pack	**U.S. List Price
2664	Square Top, fits 3958, 3959 Containers	20¾" sq x 6¼" h	22.7 lb	51.1 cm x 15.9 cm	10.3 kg	BEIG, GRAY	4	59.40
2672	Round Top, fits 2947, 3546 Containers	16¾" dia	8.6 lb	41 cm	3.9 kg	BEIG, GRAY	4	31.20
2689	Square Top, fits 3568, 3569 Containers	14¾" sq x 4¾" h	13 lb	37.8 cm x 11.4 cm	5.9 kg	BEIG, BRN, BLUE, GRAY	4	29.80
3548*	Funnel Top, Round fits 2947, 3546 Containers	16¾" dia	5.5 lb	41.3 cm	2.5 kg	GRAY	4	25.00
3620	Half Round Lid, with swing door fits 3520 Container	21¾" l x 12¾" w x 9½" h	12.2 lb	54.1 cm x 31.3 cm x 23 cm	5.5 kg	BLA	4	127.00
3624	Swing Top, Square, fits 3568, 3569 Containers	15" sq	13.4 lb	38.1 cm	6.1 kg	BRN	4	53.60

\* Allows hands-free product use.

# 16 WASTE: Indoor Utility

## Soft Wastebaskets and Untouchable® Tops

Space-efficient and economical.

- Rolled rims add strength and are easy to clean
- Fits under standard-height desk even when swing top is fully extended
- Designed for convenient desk-side waste management
- Tops provide a hygienic waste management solution without reducing wastebasket capacity
- Untouchable® Top adds an aesthetic, cost-efficient upgrade to your waste collection system



2956

2957

3071-20

### SOFT WASTEBASKETS

No.	Description	U.S. Dimensions	U.S. Capacity	U.S. Ship Wt/Ctn	Metric Dimensions	Metric Capacity	Metric Ship Wt/Ctn	Can Liners	Color	Pack	**U.S. List Price
2952	Wastebasket, Vanity	9 <sup>1</sup> / <sub>2</sub> " l x 6 <sup>1</sup> / <sub>2</sub> " w x 10 <sup>1</sup> / <sub>2</sub> " h	8 <sup>1</sup> / <sub>2</sub> qt	4.4 lb	25.1 cm x 17.1 cm x 25.7 cm	7.7 L	2 kg	5002-88 <sup>a</sup>	BEIG	6	6.40
2955	Wastebasket, Small	11 <sup>1</sup> / <sub>2</sub> " l x 8 <sup>1</sup> / <sub>4</sub> " w x 12 <sup>1</sup> / <sub>2</sub> " h	13 <sup>3</sup> / <sub>4</sub> qt	15.6 lb	28.9 cm x 21 cm x 30.8 cm	12.9 L	7.1 kg	5002-88 <sup>a</sup>	BEIG, BLA, GRAY	12	9.60
2956	Wastebasket, Medium	14 <sup>1</sup> / <sub>2</sub> " l x 10 <sup>1</sup> / <sub>2</sub> " w x 15" h	28 <sup>1</sup> / <sub>2</sub> qt	22.5 lb	36.5 cm x 26 cm x 38.1 cm	26.6 L	10.2 kg	5002-88 <sup>a</sup>	BEIG, BLA, GRAY	12	10.00
2957	Wastebasket, Large	15 <sup>1</sup> / <sub>2</sub> " l x 11" w x 19 <sup>1</sup> / <sub>2</sub> " h	41 <sup>1</sup> / <sub>2</sub> qt	29.35 lb	38.7 cm x 27.9 cm x 50.5 cm	39 L	13.3 kg	5003-88 <sup>a</sup> , 5071	BEIG, BLA, GRAY	12	19.00

<sup>a</sup> Not for sale in California.

### UNTOUCHABLE® TOPS & COMBO

No.	Description	U.S. Dimensions	U.S. Ship Wt/Ctn	Metric Dimensions	Metric Ship Wt/Ctn	Can Liners	Color	Pack	**U.S. List Price
3066	Untouchable® Top, fits 2956 Container	15" l x 10 <sup>1</sup> / <sub>2</sub> " w x 6" h	7.5 lb	38.1 cm x 27.6 cm x 15.2 cm	3.4 kg		BLA, BEIG	6	13.40
3067	Untouchable® Top, fits 2957 Container	16" l x 11 <sup>1</sup> / <sub>2</sub> " w x 7" h	8.5 lb	40.6 cm x 29.5 cm x 17.8 cm	3.9 kg		BEIG, BLA	6	14.00
3071-20	Untouchable® Top/Soft Wastebasket Combo: 3067 Lid/2957 Wastebasket		22.88 lb		10.4 kg	5003-88 <sup>a</sup>	BEIG	6	33.00

<sup>a</sup> Not for sale in California.

## Fire Resistant Wastebaskets

Contemporary shape with UL rating.

- Fiberglass containers have rounded corners for added strength
- Textured finish helps minimize appearance of surface scratches and is easy to clean
- California State Fire Marshal (CSFM) approved for fire safety
- Tested and classified by Underwriters Laboratories as able to contain burning paper without causing wastebasket meltdown



No.	Description	U.S. Dimensions	U.S. Capacity	U.S. Ship Wt/Ctn	Metric Dimensions	Metric Capacity	Metric Ship Wt/Ctn	Color	Pack	**U.S. List Price
2540	Fire Resistant Wastebasket	8 <sup>1</sup> / <sub>2</sub> " l x 6 <sup>1</sup> / <sub>2</sub> " w x 10 <sup>1</sup> / <sub>2</sub> " h	7 qt	10.2 lb	22.5 cm x 16.2 cm x 26.2 cm	6.6 L	4.6 kg	BEIG	6	20.00
2541	Fire Resistant Wastebasket	11 <sup>1</sup> / <sub>2</sub> " l x 8 <sup>1</sup> / <sub>4</sub> " w x 12 <sup>1</sup> / <sub>2</sub> " h	14 qt	17.8 lb	28.3 cm x 21 cm x 31.1 cm	13.2 L	8.1 kg	BLA, BEIG, GRAY	6	32.20
2543	Fire Resistant Wastebasket	14 <sup>1</sup> / <sub>2</sub> " l x 10 <sup>1</sup> / <sub>2</sub> " w x 15 <sup>1</sup> / <sub>2</sub> " h	28 qt	31.8 lb	36.8 cm x 26.7 cm x 38.9 cm	26.5 L	14.4 kg	BLA, BEIG, GRAY	6	48.40
2544	Fire Resistant Wastebasket	15" l x 11 <sup>1</sup> / <sub>2</sub> " w x 20" h	40 qt	33 lb	38.1 cm x 28.6 cm x 50.8 cm	37.9 L	15 kg	BEIG	4	67.20

## For Other Fire Rated Containers See:



Slim Jim®  
Wall Mounted



Step-On  
Containers



Marshal®  
Steel Containers



Atrium®  
Classic Containers



Plaza®  
Containers



Ranger®  
Classic Containers



Ash/Trash  
Containers

## Color Guide

See Product Description for Color Availability

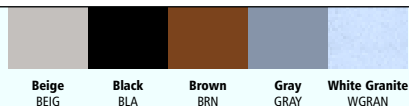

## Rigid Liners

Prolong the life of your containers.

- Designed to fit Rubbermaid and other manufacturers' containers
- Durable plastic construction maximizes service life



No.	Description	U.S. Dimensions	U.S. Capacity	U.S. Ship Wt/Ctn	Metric Dimensions	Metric Capacity	Metric Ship Wt/Ctn	Color	Pack	**U.S. List Price
3546	Rigid Liner fits 9079	15 1/4" dia x 30 3/4" h	22 gal	27.6 lb	40 cm x 76.5 cm	83.3 L	12.5 kg	BEIG, GRAY	4	59.20
3550	Rigid Liner fits 8160-88, 8184-88, 8185-88	12" dia x 27 1/4" h	12 1/2 gal	16.16 lb	30.5 cm x 69.2 cm	45.9 L	7.3 kg	GRAY	4	44.60
3552	Rigid Liner w/ Rim fits 8170-88, 8180-88, 8182-88	14 1/2" dia x 30 3/4" h	22 gal	26.9 lb	36.8 cm x 76.5 cm	83.3 L	12.2 kg	GRAY	4	58.00
3564	Rigid Liner	18 3/4" sq x 34" h	50 gal	51.405 lb	47.3 cm x 86.4 cm	189.3 L	23.3 kg	GRAY	4	117.00
3566	Rigid Liner fits 8430	16 1/4" sq x 28 1/2" h	24 1/2 gal	33.26 lb	41.3 cm x 72.4 cm	93.4 L	15.1 kg	GRAY	4	117.00
3567	Rigid Liner	18 1/2" sq x 29 1/2" h	35 1/2 gal	38.4 lb	46.4 cm x 74 cm	134.4 L	17.4 kg	GRAY	4	121.50
3568	Square Container	14 1/2" sq x 24" h	19 gal	24.93 lb	36.8 cm x 61 cm	71.9 L	11.3 kg	BEIG, GRAY	4	63.60
3569	Square Container	14 1/2" sq x 28" h	23 gal	29.34 lb	36.8 cm x 71.1 cm	87.1 L	13.3 kg	BEIG, BRN, GRAY	4	67.00
3958	Square Container fits 9171, 9173	19 1/2" sq x 27 3/4" h	35 gal	39.425 lb	49.5 cm x 70.2 cm	132.5 L	17.9 kg	BEIG, GRAY	4	108.00
3959	Square Container	19 1/2" sq x 34 1/4" h	50 gal	53.89 lb	49.5 cm x 87 cm	189.3 L	24.4 kg	BEIG, GRAY	4	150.00
6243	Rigid Liner fits 6143	14 3/4" l x 11 3/4" w x 13 1/4" h	7 1/2 gal	5.44 lb	36.5 cm x 29.8 cm x 33.7 cm	27 L	2.5 kg	GRAY	2	29.40
6244	Rigid Liner fits 6144	14 3/4" l x 11 3/4" w x 19 1/4" h	10 1/2 gal	7.89 lb	36.5 cm x 29.8 cm x 50.2 cm	38.8 L	3.6 kg	GRAY	2	37.80
6245	Rigid Liner fits 6145	18" l x 12 1/4" w x 22" h	15 gal	26.4 lb	45.7 cm x 31.1 cm x 55.9 cm	56.8 L	12 kg	GRAY	4	44.00
6246	Rigid Liner fits 6146 Mobile	18" l x 12 1/4" w x 28 1/2" h	19 gal	30.57 lb	45.7 cm x 31.1 cm x 72.4 cm	71.9 L	13.9 kg	GRAY	4	55.00
256K	Rigid Liner for Glutton® Container	23 1/4" l x 20 1/4" w x 29" h	42 gal	48.05 lb	59.1 cm x 51.4 cm x 73.7 cm	159 L	21.8 kg	GRAY	4	123.50

## Atrium® Classic Containers

Attractive open-top containers for hygienic waste disposal.

- 9058 combines the durability of plastic with the hygiene of a funnel top and the fire protection of a closed top
- Heavy-duty plastic construction with molded-in color and UV inhibitors
- Textured finish helps minimize appearance of surface scratches
- Built-in side handles ease lifting
- 9058 is FM approved



ADA



9058

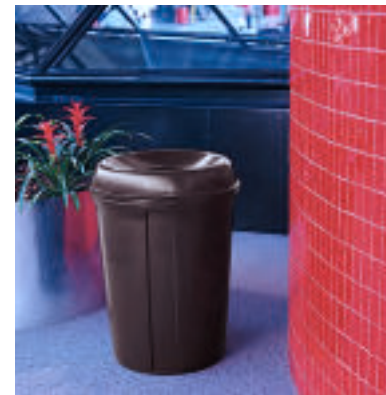

No.	Description	U.S. Dimensions	U.S. Capacity	U.S. Ship Wt/Ctn	Metric Dimensions	Metric Capacity	Metric Ship Wt/Ctn	Can Liners	Color	Pack	**U.S. List Price
9058*	Atrium® Classic Container with Funnel Top	25" dia x 33 3/4" h	35 gal	23.5 lb	63.5 cm x 84.6 cm	132.5 L	10.7 kg	5008-88 <sup>^</sup>	BLA	1	277.00
9058-86	Atrium® Classic Container with Funnel Top	25" dia x 33 3/4" h	35 gal	23.5 lb	63.5 cm x 84.6 cm	132.5 L	10.7 kg	5008-88 <sup>^</sup>	WGRAN	1	306.00

\* Custom imprinting available; contact Rubbermaid Customer Service at (800) 347-9800 for details.  
<sup>^</sup> Not for sale in California.

# 18 WASTE: Decorative Plastic Containers

## Marshal® Classic Containers

Practical good looks combined with fire safety.

- Factory Mutual (FM) and California State Fire Marshal (CSFM) approved for fire safety
- Includes retainer hardware for securing and concealing can liners
- Textured finish minimizes appearance of surface scratches



CSFM

ADA



8160-88 OWHT



8170-88 BRN



8170-88 BLA



8170-88 BEIG

No.	Description	U.S. Dimensions	U.S. Capacity	U.S. Ship Wt/Ctn	Metric Dimensions	Metric Capacity	Metric Ship Wt/Ctn	Can Liners	Color	Pack	**U.S. List Price
8160-88*	Marshal® Classic Container	15 1/2" dia x 36 1/2" h	15 gal	20.1 lb	39.1 cm x 92.7 cm	56.8 L	9.1 kg	5004-88*	BEIG, BLA, BRN, OWHT	1	163.00
8170-88*	Marshal® Classic Container	18" dia x 42" h	25 gal	23 lb	45.7 cm x 106.7 cm	94.6 L	10.4 kg	5005-88*	BEIG, BLA, BRN, OWHT	1	213.00

\* Custom imprinting available; contact Rubbermaid Customer Service at (800) 347-9800 for details.

^ Not for sale in California.

## Glutton® Containers

Large capacity containers for indoor/outdoor use.

- Perfect for large crowds and high-traffic areas
- Withstands extreme weather and handling
- Hooded top available with and without doors
- Hold-Down Base can be filled with sand or water to provide added stability and security

ADA

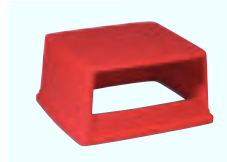

256V



256B / 256V / 256W



256X / 256B



No.	Description	U.S. Dimensions	U.S. Capacity	U.S. Ship Wt/Ctn	Metric Dimensions	Metric Capacity	Metric Ship Wt/Ctn	Can Liners	Color	Pack	**U.S. List Price
256B*	Glutton® Container	25 1/2" l x 22 1/2" w x 31 1/2" h	56 gal	67.31 lb	64.8 cm x 57.8 cm x 79.1 cm	212 L	30.5 kg	5013-88*, 5079	BRN, OWHT	4	189.00
256V*	Glutton® Hooded Top w/o doors, fits 256B	26 1/2" l x 23" w x 13" h		14.23 lb	67.6 cm x 58.4 cm x 33 cm		6.5 kg		BRN, RED	1	185.50
256X	Glutton® Hooded Top w/doors, fits 256B	26 1/2" l x 23" w x 13" h		19.2 lb	67.6 cm x 58.4 cm x 33 cm		8.7 kg		BRN, RED	1	241.00
256W	Hold Down Base for 256B	21 1/4" l x 18" w x 5" h		6.43 lb	53.7 cm x 45.7 cm x 12.7 cm		2.9 kg		BLA	1	99.80

\* Custom imprinting available; contact Rubbermaid Customer Service at (800) 347-9800 for details.

^ Not for sale in California.    ° Provides hands-free use.

## Ranger® Classic Containers

Specifically designed for outdoor use.

- Built to withstand extreme weather and handling
- Ideal for fast food restaurants, municipal parks, playgrounds, and stadiums
- Permanently attached hinged tops
- Product SKUs 8430 and 9171 are Factory Mutual (FM) and California State Fire Marshal (CSFM) approved for fire safety



CSFM

ADA



9171



8430



9173

No.	Description	U.S. Dimensions	U.S. Capacity	U.S. Ship Wt/Ctn	Metric Dimensions	Metric Capacity	Metric Ship Wt/Ctn	Can Liners	Color	Pack	**U.S. List Price
8430*	Ranger® Classic Container	19 1/2" sq x 39 1/2" h	35 gal	36.2 lb	49.5 cm x 101 cm	132.5 L	16.4 kg	5016-88*	BEIG, BRN	1	308.00
9171*	Ranger® Classic Container, Dome Top, 2 Access Openings w/Doors	28 1/2" l x 24 1/2" w x 41 1/2" h	45 gal	42.5 lb	72 cm x 62.2 cm x 104.8 cm	170.3 L	19.3 kg		BLA, BEIG, BRN	1	360.00
9173*	Ranger® Classic Container, Dome Top, 4 Access Openings w/o Doors	28 1/2" l x 24 1/2" w x 41 1/2" h	45 gal	37.6 lb	72 cm x 62.2 cm x 104.8 cm	170.3 L	17.1 kg		BLA, BEIG, BRN	1	378.00
3958*	Square Container fits 9171, 9173	19 1/2" sq x 27 1/2" h	35 gal	39.4 lb	49.5 cm x 70.2 cm	132.5 L	17.9 kg	5008-88*	BEIG, GRAY	4	108.00

\* Custom imprinting available; contact Rubbermaid Customer Service at (800) 347-9800 for details.

^ Not for sale in California.    ° Provides hands-free use.

## Color Guide

See Product Description for Color Availability

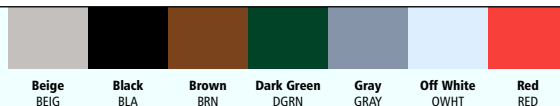



## Plaza® Containers

Contemporary styling with side opening door for “no lift” unloading.

- The 35-gallon size is ideal for tight spaces and ships fully assembled
- Spring-loaded swing doors help contain odors
- Includes bolt-down capability
- Textured top model accommodates up to 15" x 20" (38.1 cm x 50.8 cm) trays
- Product SKUs 3964 and 9P90 are Factory Mutual (FM) and California State Fire Marshal (CSFM) approved when used with 3958 and 3569 Rigid Liners, respectively



CSFM

ADA



Can be used with either a rigid liner or a can liner. Hinged front panel swings opens to allow easy waste removal.



9P90\*

The 35-gallon size is ideal for tighter spaces!



3964\*

Customize with multi-color screen imprinting on the front and back.



3963

Tray top locks during use and removes easily for cleaning.

Trays not included.



3965 and 9P91 include a convenient ashtray insert.

No.	Description	U.S. Dimensions	U.S. Capacity	U.S. Ship Wt/Ctn	Metric Dimensions	Metric Capacity	Metric Ship Wt/Ctn	Can Liners	Color	Pack	**U.S. List Price
3963*	Plaza® Container w/ Tray Top	24 <sup>3</sup> / <sub>4</sub> " l x 25 <sup>1</sup> / <sub>4</sub> " w x 43" h	50 gal	81 lb	62.9 cm x 64.1 cm x 109.2 cm	189.3 L	36.7 kg	5016-88*	BEIG, BLA	1	606.00
3964*	Plaza® Container	24 <sup>3</sup> / <sub>4</sub> " l x 25 <sup>1</sup> / <sub>4</sub> " w x 42 <sup>3</sup> / <sub>8</sub> " h	50 gal	78 lb	62.9 cm x 64.1 cm x 107 cm	189.3 L	35.4 kg	5016-88*	BLA, DGRN	1	510.00
3965*	Plaza® Container w/ Ashtray	24 <sup>3</sup> / <sub>4</sub> " l x 25 <sup>1</sup> / <sub>4</sub> " w x 42 <sup>3</sup> / <sub>8</sub> " h	50 gal	78 lb	62.9 cm x 64.1 cm x 107 cm	189.3 L	35.4 kg	5016-88*	BEIG, BLA, DGRN	1	574.00
3958	Square Container fits 3963, 3964, 3965	19 <sup>1</sup> / <sub>2</sub> " sq x 27 <sup>3</sup> / <sub>8</sub> " h	35 gal	39.4 lb	49.5 cm x 70.2 cm	132.5 L	17.9 kg	5008-88*	BEIG, GRAY	4	108.00
9P90*	Plaza® Container	21 <sup>1</sup> / <sub>8</sub> " l x 20 <sup>5</sup> / <sub>8</sub> " w x 41 <sup>1</sup> / <sub>8</sub> " h	35 gal	51.8 lb	54.45 cm x 51.6 cm x 104.3 cm	132.5 L	23.5 kg	5008-88*	BEIG, BLA, DGRN	1	444.00
9P91*	Plaza® Container w/ Ashtray	21 <sup>1</sup> / <sub>8</sub> " l x 20 <sup>5</sup> / <sub>8</sub> " w x 41 <sup>1</sup> / <sub>8</sub> " h	35 gal	53.6 lb	54.45 cm x 51.6 cm x 104.3 cm	132.5 L	24.3 kg	5008-88*	BEIG, BLA, DGRN	1	508.00

\* Custom imprinting available; contact Rubbermaid Customer Service at (800) 347-9800.

^ Not for sale in California.



## Infinity™ Decorative Waste Containers

Stylish containers with plastic/metal construction for unparalleled durability.

- Highly aesthetic design with automotive paint finish for facility image enhancement
- Available with perforated or solid panels
- Modular components allow easy refurbishing
- Ships knocked down for greater cube efficiency and lower freight
- ABS resin base will not scratch surfaces or leave rust stains
- Custom color options available
- Panels on square containers can be reversed for double the life
- Can liner strap keeps bag securely attached

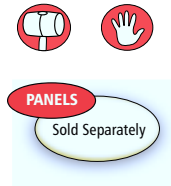

SEE IT IN ACTION  
RUBBERMAIDINFINITY.COM



## Square Containers

### FRAME KITS - TOP & BASE

No.	Description	U.S. Dimensions	U.S. Capacity	U.S. Ship Wt/Ctn	Metric Dimensions	Metric Capacity	Metric Ship Wt/Ctn	Color	Pack	**U.S. List Price
9W37	Square Funnel Top Frame	23 1/2" l x 23 1/2" w x 33" h 23 1/2" l x 23 1/2" w x 39" h	35 gal 50 gal	54.5 lb	59.7 cm x 59.7 cm x 83.8 cm 59.7 cm x 59.7 cm x 99 cm	132.5 L 189.3 L	24.7 kg	BLA	1	356.00
9W38	Square Dome Top Frame	23 1/2" l x 23 1/2" w x 41" h 23 1/2" l x 23 1/2" w x 47" h	35 gal 50 gal	53 lb	59.7 cm x 59.7 cm x 104.1 cm 59.7 cm x 59.7 cm x 119.3 cm	189.3 L 189.3 L	23.5 kg	BLA	1	512.00

### PANEL KITS - PANELS & POSTS

No.	Description	U.S. Dimensions	U.S. Capacity	U.S. Ship Wt/Ctn	Metric Dimensions	Metric Capacity	Metric Ship Wt/Ctn	Color	Pack	**U.S. List Price
9W50* <sup>A</sup>	35 Gal Perforated Square Panel Kit	29 1/2" l x 19 1/2" w x 0.06" (16ga) Thk	35 gal	40 lb	73.8 cm x 50.1 cm x 0.15 cm Thk	132.5 L	18.1 kg	DGRN, BRNZ, SILV	1	468.00
9W51* <sup>A</sup>	50 Gal Perforated Square Panel Kit	35 1/2" l x 19 1/2" w x 0.06" (16ga) Thk	50 gal	50 lb	90.6 cm x 50.1 cm x 0.15 cm Thk	189.3 L	22.6 kg	DGRN, BRNZ, SILV	1	530.00
9W55* <sup>A</sup>	35 Gal Solid Square Panel Kit	29 1/2" l x 19 1/2" w x 0.06" (16ga) Thk	35 gal	40 lb	73.8 cm x 50.1 cm x 0.15 cm Thk	189.3 L	18.1 kg	DGRN, BRNZ	1	424.00
9W56* <sup>A</sup>	50 Gal Solid Square Panel Kit	35 1/2" l x 19 1/2" w x 0.06" (16ga) Thk	50 gal	50 lb	90.6 cm x 50.1 cm x 0.15 cm Thk	189.3 L	22.6 kg	DGRN, BRNZ	1	490.00

### RIGID LINERS (OPTIONAL)

No.	Description	U.S. Dimensions	U.S. Capacity	U.S. Ship Wt/Ctn	Metric Dimensions	Metric Capacity	Metric Ship Wt/Ctn	Color	Pack	**U.S. List Price
9W63	35 Gal Rigid Liner	19 1/2" l x 19 1/2" w x 29" h	35 gal	44 lb	49.5 cm x 49.5 cm x 73.6 cm	132.5 L	19.9 kg	BLA	4	77.60
9W64	50 Gal Rigid Liner	19 1/2" l x 19 1/2" w x 36" h	50 gal	52 lb	49.5 cm x 49.5 cm x 91.4 cm	189.3 L	23.5 kg	BLA	4	102.00

## Round Containers

### FRAME KITS - TOP & BASE

No.	Description	U.S. Dimensions	U.S. Capacity	U.S. Ship Wt/Ctn	Metric Dimensions	Metric Capacity	Metric Ship Wt/Ctn	Color	Pack	**U.S. List Price
9W43	Round Funnel Top Frame	23 1/2" dia x 35" h	32 gal	50.5 lb	59.7 cm x 88.9 cm	121.13 L	22.9 kg	BLA	1	356.00
9W44	Round Dome Top Frame	23 1/2" dia x 41" h	32 gal	57 lb	59.7 cm x 104.1 cm	121.13 L	25.8 kg	BLA	1	512.00

### PANEL KITS - PANELS & POSTS

No.	Description	U.S. Dimensions	U.S. Capacity	U.S. Ship Wt/Ctn	Metric Dimensions	Metric Capacity	Metric Ship Wt/Ctn	Color	Pack	**U.S. List Price
9W50* <sup>A</sup>	32 Gal Perforated Round Panel Kit	29 1/2" l x 17" w x 0.06" (16ga) Thk	32 gal	41 lb	73.8 cm x 43.2 cm x .15 cm Thk	121.13 L	18.5 kg	DGRN, BRNZ, SILV	1	350.00
9W59* <sup>A</sup>	32 Gal Solid Round Panel Kit	29 1/2" l x 17" w x 0.06" (16ga) Thk	32 gal	41 lb	73.8 cm x 43.2 cm x .15 cm Thk	121.13 L	18.5 kg	DGRN, BRNZ	1	295.00

### RIGID LINERS (OPTIONAL)

No.	Description	U.S. Dimensions	U.S. Capacity	U.S. Ship Wt/Ctn	Metric Dimensions	Metric Capacity	Metric Ship Wt/Ctn	Color	Pack	**U.S. List Price
9W62 <sup>a</sup>	32 Gal Round Liner	18 1/2" dia x 29" h	32 gal	32 lb	46.9 cm x 73.6 cm	121.13 L	14.5 kg	BLA	4	91.40

\* Panel Kit = 4 Panels, 4 Posts (Square); 3 Panels, 3 Posts (Round).

<sup>a</sup> Custom colors and imprinting available; contact Rubbermaid Customer Service at (800) 347-9800.





<sup>b</sup> Pallet Pack = 4 ctn/pallet, 1 liner/ctn.

## Color Guide

See Product Description for Color Availability

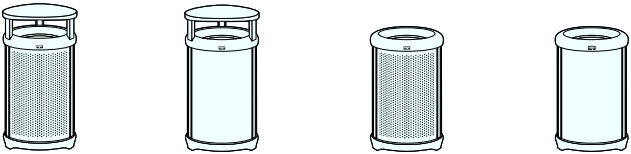
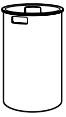

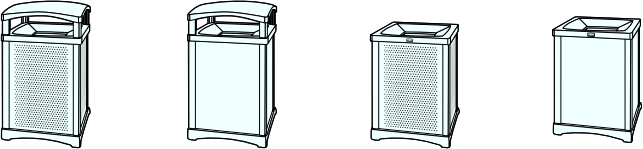
## Infinity™ 3-Step Ordering Process

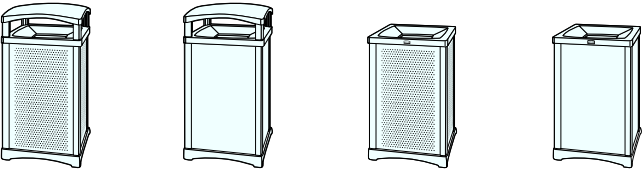
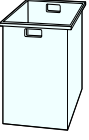
	STEP 1: CHOOSE A STYLE	STEP 2: ADD A LINER	STEP 3: CHOOSE A COLOR	
<b>ROUND 32 GALLON</b>	 <p>23½" dia. x 41" h <b>9W44</b> Round Dome Top &amp; Base Kit <b>9W54</b> 32 Gal Round Perforated Panel Kit</p> <p>23½" dia. x 41" h <b>9W44</b> Round Dome Top &amp; Base Kit <b>9W59</b> 32 Gal Round Solid Panel Kit</p> <p>23½" dia. x 35" h <b>9W43</b> Round Funnel Top &amp; Base Kit <b>9W54</b> 32 Gal Round Perforated Panel Kit</p> <p>23½" dia. x 35" h <b>9W43</b> Round Funnel Top &amp; Base Kit <b>9W59</b> 32 Gal Round Solid Panel Kit</p>	 <p>18½" dia. x 29" h <b>9W62</b> 32 Gal Round Optional Rigid Liner</p>	<p><b>STANDARD COLORS</b> Solid Panels: Perforated Panels:</p>  <p>Green Bronze Silver Bronze Green</p> <p><b>CUSTOM COLORS</b> Minimum order of 25 containers; extended lead times apply. Choose from over 150 colors.</p> <p><b>CUSTOM LOGO APPLICATION</b> Minimum order of 25 containers; extended lead times apply. Logo applications available as screen printing or vinyl on solid panels only.</p>	
	<b>SQUARE 35 GALLON</b>	 <p>23½" sqr. x 41" h <b>9W38</b> Square Dome Top &amp; Base Kit <b>9W50</b> 35 Gal Square Perforated Panel Kit</p> <p>23½" sqr. x 41" h <b>9W38</b> Square Dome Top &amp; Base Kit <b>9W55</b> 35 Gal Square Solid Panel Kit</p> <p>23½" sqr. x 33" h <b>9W37</b> Square Funnel Top &amp; Base Kit <b>9W50</b> 35 Gal Square Perforated Panel Kit</p> <p>23½" sqr. x 33" h <b>9W37</b> Square Funnel Top &amp; Base Kit <b>9W55</b> 35 Gal Square Solid Panel Kit</p>	 <p>19½" sqr. x 29" h <b>9W63</b> 35 Gal Square Optional Rigid Liner</p>	<p><b>STANDARD COLORS</b> Solid Panels: Perforated Panels:</p>  <p>Green Bronze Silver Bronze Green</p> <p><b>CUSTOM COLORS</b> Minimum order of 25 containers; extended lead times apply. Choose from over 150 colors.</p> <p><b>CUSTOM LOGO APPLICATION</b> Minimum order of 25 containers; extended lead times apply. Logo applications available as screen printing or vinyl on solid panels only.</p>
		<b>SQUARE 50 GALLON</b>	 <p>23½" sqr. x 47" h <b>9W38</b> Square Dome Top &amp; Base Kit <b>9W51</b> 50 Gal Perforated Panel Kit</p> <p>23½" sqr. x 47" h <b>9W38</b> Square Dome Top &amp; Base Kit <b>9W56</b> 50 Gal Solid Panel Kit</p> <p>23½" sqr. x 39" h <b>9W37</b> Square Funnel Top &amp; Base Kit <b>9W51</b> 50 Gal Perforated Panel Kit</p> <p>23½" sqr. x 39" h <b>9W37</b> Square Funnel Top &amp; Base Kit <b>9W56</b> 50 Gal Solid Panel Kit</p>	 <p>19½" sqr. x 36" h <b>9W64</b> 50 Gal Square Optional Rigid Liner</p>

## THE INFINITY™ CUSTOM DESIGN PROGRAM

TO LEARN MORE, CONTACT RUBBERMAID CUSTOMER SERVICE  
AT 1-800-347-9800 OR VISIT US ONLINE AT  
[WWW.RUBBERMAIDINFINITY.COM](http://WWW.RUBBERMAIDINFINITY.COM).



# 22 WASTE: Decorative Metal Containers

## Landmark Series® Classic Containers

High volume refuse collection and smoking management for indoor and outdoor areas, including building entrances, lobbies, and malls.

- Choose Dome Top model for outdoor use or Funnel Top model for indoor use
- Tops are hinged and include a stay-open strap for easy access to Rigid Liner
- Ash/Trash models include metal sand pan and large refuse openings
- Locking Dome Top model (3970-88) provides added security



### CLEAR PANEL OPTION

- Generate revenue by selling advertising space or promoting products on your containers
- High-impact acrylic panels supported by rigid poly backing for durability & weather resistance
- Tamper-resistant frame discourages vandalism of advertising materials



3966 / 4002









3970-01 / 4003

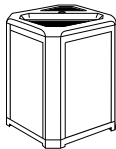
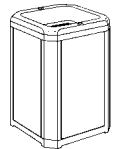
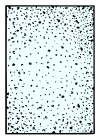
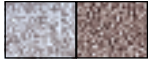
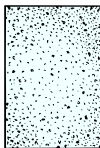

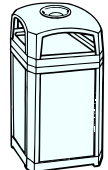
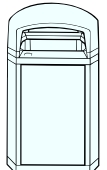
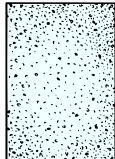
3975 / 4005

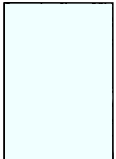
## 2-STEP ORDERING PROCESS

STEP 1: CHOOSE FRAME SIZE & STYLE		STEP 2: CHOOSE PANELS (4 PANELS PER UNIT)	
 <p><b>FUNNEL TOP ASH/TRASH CONTAINER</b> Available in 20 Gal and 35 Gal</p>	 <p><b>FUNNEL TOP</b> Available in 20 Gal and 35 Gal</p>	 <p><b>4002</b> Fits 20 Gal Landmark Series® Containers</p>  <p><b>Coral CORL</b>   <b>River Rock ROCK</b></p>	 <p><b>4003</b> Fits 35 Gal Landmark Series® Containers</p>  <p><b>Brown Stone BSTON</b>   <b>Coral CORL</b>   <b>River Rock ROCK</b></p>
 <p><b>DOME TOP ASH/TRASH CONTAINER</b> Available in 35 Gal and 50 Gal</p>	 <p><b>DOME TOP</b> Available in 35 Gal and 50 Gal</p>	 <p><b>4004</b> Fits 50 Gal Landmark Series® Containers</p>  <p><b>Brown Stone BSTON</b>   <b>Coral CORL</b>   <b>River Rock ROCK</b></p>	 <p><b>4005</b> Fits 50 Gal Landmark Series® Containers</p>  <p><b>Clear CLR</b></p>

No.	Description (w/o Panels)	U.S. Dimensions	U.S. Capacity	U.S. Ship Wt/Ctn	Metric Dimensions	Metric Capacity	Metric Ship Wt/Ctn	Can Liners	Color	Pack	**U.S. List Price
3966	Funnel Top Ash/Trash Frame with 3569 Rigid Liner	21" sq x 30½" h	20 gal	32.8 lb	53.3 cm x 77.5 cm	75.7 L	14.9 kg	5009-88*	DWOOD, SBLE	1	450.00
3967	Funnel Top Frame with 3569 Rigid Liner	21" sq x 30½" h	20 gal	33.6 lb	53.3 cm x 77.5 cm	75.7 L	15.2 kg	5009-88*	SBLE	1	410.00
3970	Dome Top Frame with 3958 Rigid Liner	26" sq x 40" h	35 gal	49.55 lb	66 cm x 101.6 cm	132.5 L	22.5 kg	5016-88*	DWOOD, SBLE, BLA	1	580.00
3970-01	Dome Top with Ashtray, Frame and 3958 Rigid Liner	26" sq x 40" h	35 gal	51.55 lb	66 cm x 101.6 cm	132.5 L	23.4 kg		DWOOD, SBLE, BLA	1	680.00
3970-88	Dome Top Frame with Lock Option, w/ 3958 Rigid Liner	26" sq x 40" h	35 gal	48.9 lb	66 cm x 101.6 cm	132.5 L	22.2 kg		BLA	1	618.00
3971	Funnel Top Ash/Trash Frame with 3958 Rigid Liner	26" sq x 30½" h	35 gal	43.4 lb	66 cm x 77.5 cm	132.5 L	19.7 kg	5016-88*	DWOOD, SBLE	1	544.00
3972	Funnel Top Frame with 3958 Rigid Liner	26" sq x 30½" h	35 gal	43 lb	66 cm x 77.5 cm	132.5 L	19.5 kg	5016-88*	SBLE	1	522.00
3975	Dome Top Frame with 3959 Rigid Liner	26" sq x 46½" h	50 gal	55.5 lb	66 cm x 118.1 cm	189.3 L	25.2 kg	5016-88*	DWOOD, SBLE, BLA	1	636.00
3975-01	Dome Top with Ashtray, Frame and 3959 Rigid Liner	26" sq x 46½" h	50 gal	58.15 lb	66 cm x 118.1 cm	189.3 L	26.4 kg		DWOOD, SBLE, BLA	1	736.00

\* Not for sale in California.

### PANELS (SOLD SEPARATELY)

No.	Description	U.S. Dimensions	U.S. Capacity	U.S. Ship Wt/Ctn	Metric Dimensions	Metric Capacity	Metric Ship Wt/Ctn	Can Liners	Color	Pack	**U.S. List Price
4002	Aggregate Panel fits 3966, 3967	27½" l x 15½" w x ¾" h		34.895 lb	70.8 cm x 39.8 cm x .9 cm		15.8 kg		CORL, ROCK	4	44.00
4003	Aggregate Panel fits 3970, 3970-01, 3970-88, 3971, 3972	27½" l x 20½" w x ¾" h		38.68 lb	70.8 cm x 52.7 cm x .9 cm		17.5 kg		BSTON, CORL, ROCK	4	47.00
4004	Aggregate Panel fits 3975, 3975-01	34½" l x 20½" w x ¾" h		48.96 lb	87.1 cm x 52.2 cm x .9 cm		22.2 kg		BSTON, CORL, ROCK	4	60.00
4005	Panels w/ backing for advertising 3975, 3975-01	34½" l x 20½" w x ¾" h		22 lb	87.1 cm x 52.2 cm x .9 cm		9.9 kg		CLR	4	64.20

## Color Guide

See Product Description for Color Availability



Black   Brown Stone   Landmark Steel Brn/Brn   Sable   Drift Wood   Coral   Clear   River Rock  
BLA   BSTON   Steel Brn/Brn   SBLE   DWOOD   CORL   CLR   ROCK

## Landmark Series® Steel Containers

Classic look with steel construction comes fully assembled, including aggregate panels (except 3989).

- Suitable for both indoor and outdoor applications
- Heavy gauge, hot dipped galvanized steel provides corrosion resistance
- Stone panels have Class B fire rating
- UV-stabilized powder coat finish protects color and helps extend product life
- Spun aluminum ashtrays for reduced maintenance and longer life
- Side Door model (3979) provides full interior access for "no lift" refuse removal

ADA



3982



3984



3989

IDEAL FOR LOGO APPLICATION OR CUSTOM ADVERTISING.



3979



3974



3973

No.	Description	U.S. Dimensions	U.S. Capacity	U.S. Ship Wt/Ctn	U.S. Liner Capacity	Metric Dimensions	Metric Capacity	Metric Ship Wt/Ctn	Metric Liner Capacity	Color	Pack	**U.S. List Price
3973	Ash/Trash Sand Top	13½" sq x 34" h	12 gal	53.4 lb	GL 9.5 gal	34.3 cm x 86.4 cm	45.4 L	24.2 kg	GL 36 L	BBRN	1	518.00
3974	Ash/Trash Sand Top	17½" sq x 34¾" h	24 gal	68.9 lb	GL 20 gal	44.5 cm x 88.4 cm	90.8 L	31.2 kg	GL 75.7 L	BBRN	1	600.00
3978	Smoking Urn	10½" sq x 25¼" h	N/A	29.3 lb	N/A	26 cm x 65.6 cm	N/A	13.3 kg	N/A	BBRN	1	237.00
3979	Side Door	26" sq x 43¾" h	38 gal	128.4 lb	GL 34.5 gal	66.7 cm x 111.6 cm	143.8 L	58.2 kg	GL 130.6 L	BBRN	1	1,160.00
3982	Ash/Trash Sand	10½" sq x 25¼" h	4.2 gal	29.3 lb	GL 2.5 gal	26 cm x 65.6 cm	15.8 L	13.3 kg	GL 9.5 L	BBRN	1	312.00
3984	Dome Top	17½" sq x 34¾" h	24 gal	68.9 lb	GL 20 gal	44.5 cm x 88.4 cm	90.8 L	31.2 kg	GL 75.7 L	BBRN	1	530.00
3986	Hinged Dome Top	21" sq x 42¼" h	29 gal	97.8 lb	GL 24 gal	53.3 cm x 106.8 cm	109.8 L	44.4 kg	GL 90.8 L	BBRN	1	884.00
3988	Hinged Dome Top	26" sq x 43¾" h	48 gal	125.4 lb	GL 43 gal	66.7 cm x 111.6 cm	181.7 L	56.9 kg	GL 162.8 L	BBRN	1	1,090.00
3989*	Hinged Dome Top w/ 4 imprintable advertising panels	26" sq x 43¾" h	48 gal	123.5 lb	GL 43 gal	66.7 cm x 111.6 cm	181.7 L	56 kg	GL 162.8 L	BBRN	1	840.00

\* Custom imprinting available; contact Rubbermaid Customer Service at (800) 347-9800. GL indicates galvanized liner.

## Landmark Series® Security Containers

The solution for secure, effective, and affordable waste management.

- Complies with Department of Homeland Security Directive SD RAILPAX-04-01
- Provides total visibility of contents for improved security
- Constructed of durable, chemical resistant, engineered polymer for easy cleaning and long life
- Locking dome top and bolt-down capability for added security
- Can liner retainer band for easy servicing
- Fully assembled unit for quick deployment and lower set-up costs

ADA



No.	Description	U.S. Dimensions	U.S. Capacity	U.S. Ship Wt/Ctn	Metric Dimensions	Metric Capacity	Metric Ship Wt/Ctn	Can Liners	Color	Pack	**U.S. List Price
3975-89	Landmark Series® Security Container w/lock and clear panels	26" sq x 46½" h	50 gal	62.4 lb	66 cm. sq x 118.1 cm h	189.3 L	28.3 kg	5016-88 <sup>a</sup>	BLA	1	1,102.00
4006	Clear Replacement Panel for 3970, 3970-01, 3970-88, 3971, 3972	20½" w x 27½" l x 2¼" h	Fits 35 gal Landmark Series	14.8 lb	52.1 cm x 70.9 cm x 7 cm	Fits 132.5 L	6.7 kg		CLR	4	111.00
4007	Clear Replacement Panel for 3975, 3975-01, 3975-89	20½" w x 34" l x 2¼" h	Fits 50 gal Landmark Series	17.7 lb	52.1 cm x 86.4 cm x 7 cm	Fits 189.3 L	8.0 kg		CLR	4	125.00

<sup>a</sup> Not for sale in California.

## WeatherGard® Series Containers

Architectural heavy-duty steel construction.

- Steel cable mechanism secures lid to container to help prevent theft
- Adjustable feet stabilize the container on uneven surfaces
- Steel construction
- UV-stabilized powder coat finish
- No assembly required

ADA



Molded-in handles provide easy removal of a BRUTE® Rigid Liner.



4021



No.	Description	U.S. Dimensions	U.S. Capacity	U.S. Ship Wt/Ctn	Metric Dimensions	Metric Capacity	Metric Ship Wt/Ctn	Color	Pack	**U.S. List Price
4020	WeatherGard® Series Container w/ 20 U.S. gal (75.7 L) BRUTE® Container Rigid Liner	27 $\frac{1}{2}$ " dia x 27 $\frac{1}{2}$ " h	20 gal	73.7 lb	69.2 cm x 69.9 cm	75.7 L	33.4 kg	BLA	1	818.00
4021	WeatherGard® Series Container w/ 32 U.S. gal (121.1 L) BRUTE® Container Rigid Liner	30 $\frac{1}{2}$ " dia x 32" h	32 gal	98.9 lb	76.5 cm x 81.3 cm	121.1 L	44.9 kg	BLA	1	1,002.00

## Atrium® Aluminum Containers

Ideal for use in airports, office buildings, and malls.

- Heavy gauge aluminum is corrosion-resistant
- Fire-safe construction
- Hammered Silver finish is highly scratch-resistant
- High-quality polish on Satin finish eliminates spinning lines and blemishes
- Both models are corrosion-resistant, fire-safe, and ADA compliant



ADA



Extended overlap area eliminates visible bag overhang.



9079 Hammered Silver

9079 Satin Finish

No.	Description	U.S. Dimensions	U.S. Capacity	U.S. Ship Wt/Ctn	Metric Dimensions	Metric Capacity	Metric Ship Wt/Ctn	Can Liners	Finish	Pack	**U.S. List Price
9079	Atrium® Aluminum Container, Open Top	18" dia x 32 $\frac{1}{4}$ " h	35 gal	32.65 lb	45.7 cm x 81.9 cm	132.5 L	14.8 kg	5008-88	HSILV, SALUM	1	670.00
3546	Rigid Liner fits 9079	15 $\frac{1}{2}$ " dia x 30 $\frac{1}{4}$ " h	22 gal	27.6 lb	40 cm x 76.5 cm	83.3 L	12.5 kg	5004-88 <sup>a</sup>	BEIG, GRAY	4	59.20

<sup>a</sup> Not for sale in California.

### Color Guide

See Product Description for Color Availability



Beige    Black    Gray    Hammered Silver    Mirror Stainless    Satin Aluminum    Satin Stainless    White  
 BEIG    BLA    GRAY    HSILV    MSSTL    SALUM    SSSTL    WHT

## Marshal® Steel Containers

Decorative, indoor waste management.

- Excellent for indoor and protected outdoor applications
- Stainless steel containers constructed of #304 heavy gauge material
- Powder coated steel containers constructed of heavy gauge galvanized steel
- Self-closing, reinforced, mirror-polished stainless steel door
- Stainless steel, corrosion-resistant reinforcing bottom rim protects floors
- Recessed hand grips offer easy lifting for refuse removal
- Product SKUs 9630, 9631, and 9632 are Factory Mutual (FM) approved for fire safety



ADA



9630



9626



9631



9632



9624

### STAINLESS STEEL

No.	Description	U.S. Dimensions	U.S. Capacity	U.S. Ship Wt/Ctn	U.S. Liner Capacity	Metric Dimensions	Metric Capacity	Metric Ship Wt/Ctn	Metric Liner Capacity	Color	Pack	**U.S. List Price
9615	Marshal® Steel Container	15 1/4" dia x 30 1/2" h	12 gal	21.45 lb	PL 9 gal	38.7 cm x 77.5 cm	45.4 L	9.7 kg	PL 34.1 L	MSSTL	1	388.00
9624	Marshal® Steel Container	15 1/4" dia x 36 1/2" h	15 gal	24.65 lb	PL 12 1/2 gal	38.7 cm x 92.7 cm	56.8 L	11.2 kg	PL 47.3 L	MSSTL	1	418.00
9630	Marshal® Steel Container	15 1/4" dia x 36 1/2" h	15 gal	24.65 lb	GL 13 3/4 gal	38.7 cm x 92.7 cm	56.8 L	11.2 kg	GL 52 L	MSSTL	1	418.00
9632	Marshal® Steel Container	15 1/4" dia x 36 1/2" h	15 gal	24.65 lb	GL 13 3/4 gal	38.7 cm x 92.7 cm	56.8 L	11.2 kg	GL 52 L	SSSTL	1	293.00

GL indicates galvanized liner; PL indicates plastic liner.

### POWDER COATED STEEL

No.	Description	U.S. Dimensions	U.S. Capacity	U.S. Ship Wt/Ctn	U.S. Liner Capacity	Metric Dimensions	Metric Capacity	Metric Ship Wt/Ctn	Metric Liner Capacity	Color	Pack	**U.S. List Price
9626	Marshal® Steel Container	15 1/4" dia x 36 1/2" h	15 gal	24.65 lb	PL 12 1/2 gal	38.7 cm x 92.7 cm	56.8 L	11.2 kg	PL 47.3 L	BLA	1	174.50
9631	Marshal® Steel Container	15 1/4" dia x 36 1/2" h	15 gal	24.65 lb	GL 13 3/4 gal	38.7 cm x 92.7 cm	56.8 L	11.2 kg	GL 52 L	BEIG, WHT	1	174.50

GL indicates galvanized liner; PL indicates plastic liner.

## Atrium® Steel Containers

Decorative, indoor waste management.

- Excellent for indoor and protected outdoor applications
- Fire-safe construction; 9066 is UL rated
- 9066 and 9104 constructed of heavy gauge stainless steel
- 9106 constructed of heavy gauge galvanized steel with powder coat finish
- Protective trim on all openings protects containers and reduces potential for injury
- Spun aluminum ashtrays for reduced maintenance and longer life



ADA



9066



9104



9106

No.	Description	U.S. Dimensions	U.S. Capacity	U.S. Ship Wt/Ctn	U.S. Liner	Metric Dimensions	Metric Capacity	Metric Ship Wt/Ctn	Metric Liner	Color	Pack	**U.S. List Price
9066	Atrium® Steel Container, Open Top	14 3/4" dia x 28 1/2" h	15 gal	22.95 lb	GL 11 gal	37.1 cm x 72.4 cm	56.8 L	10.4 kg	GL 41.6 L	MSSTL	1	265.00
9104	Atrium® Steel Container, Ash/Trash Sand Top	15" dia x 28 3/4" h	12 gal	23.45 lb	GL 11 gal	38.1 cm x 73 cm	45.4 L	10.6 kg	GL 41.6 L	MSSTL	1	350.00
9106	Atrium® Steel Container, Ash/Trash Sand Top	15" dia x 28 3/4" h	12 gal	23.45 lb	GL 11 gal	38.1 cm x 73 cm	45.4 L	10.6 kg	GL 41.6 L	BLA	1	214.00

GL indicates galvanized liner.

# 26 WASTE: Decorative Fiberglass Containers

## Ranger® Fiberglass Containers

Perfect for indoor and outdoor locations.

- Constructed with Class 1 fire-retardant resin
- UV-stabilized Gel-Coat protects color
- Smooth-walled construction is easy to clean
- Vinyl trim on Radius Top and Tray Top models prevent chipping and cracking, helping reduce potential for injury
- Equipped with plastic rigid liners



9652



9652

Tray Top model is ideal for food court locations.

No.	Description	U.S. Dimensions	U.S. Capacity	U.S. Ship Wt/Ctn	U.S. Liner Capacity	Metric Dimensions	Metric Capacity	Metric Ship Wt/Ctn	Metric Liner Capacity	Color	Pack	**U.S. List Price
9650	Ranger® Fiberglass Container, Funnel Top	16" sq x 29½" h	32 gal	25.7 lb	PL 20 gal	40.6 cm x 74.3 cm	121.1 L	11.7 kg	PL 75.7 L	ALMD, BLA, GRAY	1	872.00
9651	Ranger® Fiberglass Container, Radius Top	20¼" sq x 36" h	42 gal	43.6 lb	PL 31 gal	51.4 cm x 91.4 cm	159 L	19.7 kg	PL 117.3 L	ALMD, BLA, GRAY	1	984.00
9652	Ranger® Fiberglass Container, Tray Top	20" sq x 35" h	42 gal	43.5 lb	PL 31 gal	50.8 cm x 88.9 cm	159 L	19.7 kg	PL 117.3 L	ALMD, BLA	1	984.00

PL indicates rigid plastic liner.

## Atrium® Fiberglass Containers

Perfect for entranceways and lobbies.

- Constructed with Class 1 fire-retardant resin
- UV-stabilized, Gel-Coat protects color
- Smooth-walled construction is easy to clean
- Equipped with plastic rigid liners



Vinyl trim prevents chipping and cracking.



9111



9112

No.	Description	U.S. Dimensions	U.S. Capacity	U.S. Ship Wt/Ctn	U.S. Liner Capacity	Metric Dimensions	Metric Capacity	Metric Ship Wt/Ctn	Metric Liner Capacity	Finish/Color	Pack	**U.S. List Price
9111	Atrium® Fiberglass Container, Radius Top	18½" dia x 30½" h	28 gal	27.35 lb	PL 19 gal	46 cm x 76.8 cm	106 L	12.4 kg	PL 71.9 L	ALMD, BLA, GRAY	1	668.00
9112	Atrium® Fiberglass Container, Dome Top	17¾" dia x 38" h	28 gal	27.75 lb	PL 19 gal	45.1 cm x 97.2 cm	106 L	12.6 kg	PL 71.9 L	ALMD, BLA, GRAY	1	744.00

PL indicates plastic liner.

### Color Guide

See Product Description for Color Availability



Almond ALMD Black BLA Gray GRAY Light Gray Platinum LGRAY Light Gray LPLAT



## Confidential Waste Containers

Comprehensive secure document solution to help meet HIPAA requirements.

- Standard keyed lock provides increased security
- All containers ship fully assembled for immediate use
- Slim Jim® Confidential Document Containers are ideal for placement under desks, nursing stations, and counters; side entry slot provides easy access
- The large capacity BRUTE® Confidential Document Rollout Carts allow bulk collection and mobility, and are compatible with semi-automatic and automatic lift systems
- The Metal Secure Document Container with side entry slot and flat top is ideal for extra storage
- BRUTE® Confidential Document Rollout Containers contain a UV stabilizer



9W17



9W11-88



9W10-88



9W15

9W25



9W10-88

9W25 (2 qty.)

### SLIM JIM® CONFIDENTIAL DOCUMENT CONTAINERS

No.	Description	U.S. Dimensions	U.S. Capacity	U.S. Ship Wt/Ctn	Metric Dimensions	Metric Capacity	Metric Ship Wt/Ctn	Color	Pack	**U.S. List Price
9W15	Slim Jim® Confidential Document Container w/ Lid	20" l x 11" w x 31" h	23 gal	41.17 lb	50.8 cm x 27.9 cm x 78.7 cm	87.1 L	18.67 kg	LGRAY	4	160.50
9W16	Slim Jim® Confidential Document Container Lids, fits: 3540, 3541 and 3554 Containers	20½" l x 11½" w x 2¼" h		5.96 lb	52.1 cm x 29.5 cm x 5.7 cm		2.70 kg	LGRAY	4	49.80
9W25	Slim Jim® Confidential Document Container w/ Lid	23½" l x 11" w x 24½" h	15½ gal	29.25 lb	58.7 cm x 27.9 cm x 63.2 cm	60 L	13.27 kg	LGRAY	4	121.00

### BRUTE® CONFIDENTIAL DOCUMENT ROLLOUT CONTAINERS

No.	Description	U.S. Dimensions	U.S. Capacity	U.S. Ship Wt/Ctn	Metric Dimensions	Metric Capacity	Metric Ship Wt/Ctn	Color	Pack	**U.S. List Price
9W10-88	BRUTE® Confidential Document Rollout Container	32½" l x 25¼" w x 41¾" h	65 gal	30.6 lb	82 cm x 64.3 cm x 106.2 cm	246.05 L	13.9 kg	GRAY	1	270.00
9W11-88	BRUTE® Confidential Document Rollout Container	35½" l x 27¼" w x 45¾" h	95 gal	41.0 lb	89.9 cm x 69.3 cm x 115.8 cm	359.6 L	18.6 kg	GRAY	1	297.00

### METAL CONFIDENTIAL DOCUMENT CONTAINERS

No.	Description	U.S. Dimensions	U.S. Capacity	U.S. Ship Wt/Ctn	Metric Dimensions	Metric Capacity	Metric Ship Wt/Ctn	Color	Pack	**U.S. List Price
9W17	Metal Confidential Document Container with Confidential Document Bag	18½" l x 20¼" w x 31" h	36 gal	43 lb	47.6 cm x 52.7 cm x 78.8 cm	136.3 L	19.50 kg	LPLAT	1	310.00

## Infinity™ Smoking Management Solutions **New!**

Sophisticated styling and all-metal construction for attractive and efficient smoking litter management. Includes unobstructed funnels to reduce jamming during cigarette disposal.

- High-capacity receptacles for heavy traffic areas
- Stainless steel snuff plates
- Weighted bases and bolt-down options for added stability outdoors
- 360° disposal area
- Guidance tabs on collars and bases enable simple removal and reattachment of receptacles during cleaning
- Domed tops for weather resistance
- Integrated padlock tabs provide security against tampering and theft

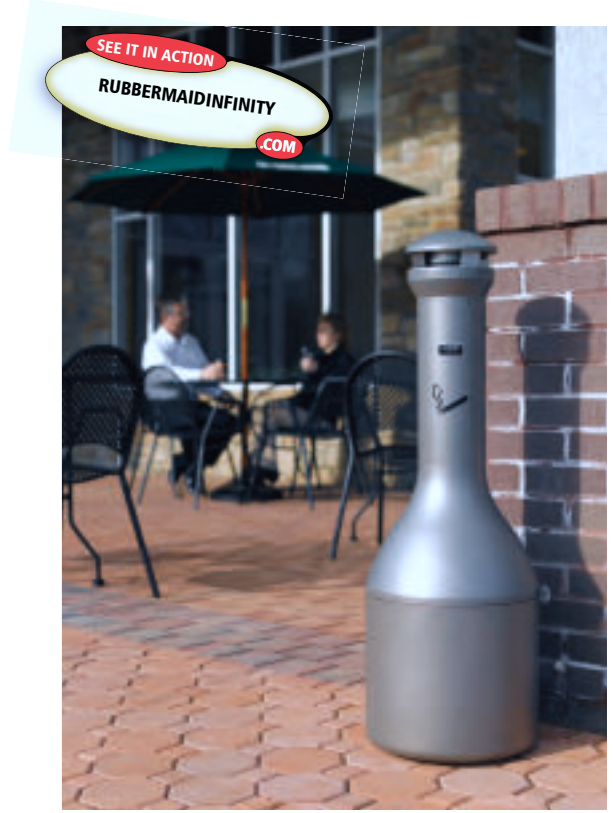

9W31



9W34 shown in Aged Bronze



**ULTRA-HIGH CAPACITY**  
9W34



**TRADITIONAL**  
9W33



**BASE-MOUNT**  
9W31



**WALL-MOUNT**  
9W32

### INFINITY™ SMOKING MANAGEMENT

No.	Description	U.S. Dimensions	U.S. Capacity	U.S. Ship Wt/Ctn	Metric Dimensions	Metric Capacity	Metric Ship Wt/Ctn	Cigarette Count	Color	Pack	**U.S. List Price
9W31	Base-Mount	15½" w x 39¾" h	1.3 gal	23.25 lb	39.4 cm x 100.6 cm	4.9 L	1.1 kg	1500*	SSBLA	1	270.00
9W32	Wall-Mount	11¾" w x 18¾" h	0.6 gal	11.98 lb	29.5 cm x 47.2 cm	2.3 L	0.5 kg	700*	SSBLA	1	170.00
9W33	Traditional	13" w x 39" h	4.1 gal	23.75 lb	33.0 cm x 99.1 cm	15.5 L	1.1 kg	5000*	BLA, AGBRNZ, ATPWTR	1	190.00
9W34	Ultra-High Capacity	15½" w x 41½" h	6.7 gal	32.52 lb	39.4 cm x 105.4 cm	25.4 L	1.6 kg	8000*	BLA, AGBRNZ, ATPWTR	1	260.00

\* Based on estimated 1,200 cigarette butts per gallon.

### Color Guide

See Product Description for Color Availability

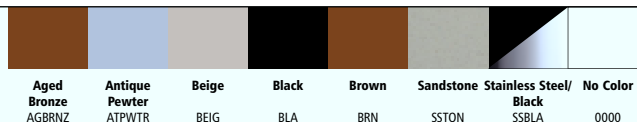

## GroundsKeeper® Smoking Management Receptacles

Classic, all-weather solution to an unsightly environmental problem.

- Hygienic, easy-to-service steel canister
- Restricted opening shields cigarette butts from view, weather, and flow of oxygen
- Galvanized steel inner canister securely holds large quantities of cigarette waste
- Steel base plate adds weight for stability and discourages theft
- Optional Weight Ring (6284) available for added stability



Tuscan style combines clean good looks with easy GroundsKeeper® maintenance.

- Upscale, aesthetic design blends with many architectural styles
- Stainless steel snuff plate minimizes smoldering
- Anchor holes for added security
- Sandstone finish complements stone, brick, natural environments, and other settings with warm hues
- Versatile black finish complements most environments including those with granite, marble, and wood siding

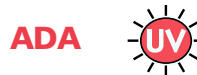

Galvanized steel cigarette waste collector holds large quantities of disposed cigarettes and allows easy disposal.



2570-88



9W30



Stainless steel snuff plate minimizes smoldering.

No.	Description	U.S. Dimensions	U.S. Ship Wt/Ctn	Metric Dimensions	Metric Ship Wt/Ctn	Color	Pack	**U.S. List Price
2570-88*	GroundsKeeper®	12½" l x 12¼" w x 39⅞" h	15.5 lb	31.1 cm x 31.1 cm x 100.1 cm	7.1 kg	BRN, BLA, BEIG	1	107.50
6284	Weight Ring	12½" l x 12½" w x 1" h	10 lb	31.8 cm x 31.8 cm x 2.5 cm	4.5 kg	BLA	1	35.00
9W29	Security Kit for GroundsKeeper® Tuscan Receptacle	-	2.8 lb		1.27 kg	0000	9	20.40
9W30	GroundsKeeper® Tuscan Receptacle	13" l x 13" w x 38⅞" h	15.4 lb	33 cm x 33 cm x 97.4 cm	6.98 kg	BLA, SSTON	1	134.50

\* Custom imprinting available; contact Rubbermaid Customer Service at (800) 347-9800.

## For Other Smoking Management Products See:



Landmark Series®  
Classic Containers



Landmark Series®  
Steel Containers



Slim Jim®  
Containers



Ash/Trash  
Containers

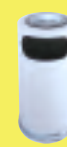

Atrium®  
Steel Containers



Plaza®  
Containers

## Ash/Trash Containers

Combine waste and smoking management for efficiency.

### CLASSIC CONTAINERS

- Ashtray can be permanently attached or left unattached for easy emptying
- Rugged construction resists dents and scratches
- Retainer hardware secures and conceals Can Liners
- Doors on both sides provide easy access for trash disposal
- Textured finish helps minimize appearance of surface scratches
- Products SKUs 8180-88 and 8184-88 are California State Fire Marshal (CSFM) approved for fire safety



8185-88



8180-88



9601



9606

### STEEL CONTAINERS

- Fire-safe construction
- Stainless steel containers are constructed with rust resistant heavy gauge #304 material
- Powder coat containers are constructed with heavy gauge galvanized steel
- Protective trim on all openings protects containers and helps reduce potential for injury
- Spun aluminum ashtray

ADA



### CLASSIC CONTAINERS

No.	Description	U.S. Dimensions	U.S. Capacity	U.S. Ship Wt/Ctn	Metric Dimensions	Metric Capacity	Metric Ship Wt/Ctn	Can Liners	Color	Pack	**U.S. List Price
8180-88	Ash/Trash Classic Container w/ doors	18" dia x 42 1/4" h	25 gal	27.65 lb	45.7 cm x 107.3 cm	94.6 L	12.5 kg	5005-88*	BEIG, BRN	1	442.00
8182-88*	Ash/Trash Classic Container w/o doors	18" dia x 42 1/4" h	25 gal	25.95 lb	45.7 cm x 107.3 cm	94.6 L	11.8 kg	5005-88*	BEIG	1	386.00
8184-88	Ash/Trash Classic Container w/ doors	15 1/2" dia x 38" h	15 gal	21.25 lb	39.4 cm x 96.5 cm	56.8 L	9.6 kg	5004-88*	BEIG	1	368.00
8185-88*	Ash/Trash Classic Container w/o doors	15 1/2" dia x 38" h	15 gal	19.6 lb	39.4 cm x 96.5 cm	56.8 L	8.9 kg	5004-88*, 5005-88*	BEIG	1	314.00
3550	Rigid Liner fits 8184-88, 8185-88	12" dia x 27 1/4" h	12 1/2 gal	16.16 lb	30.5 cm x 69.2 cm	45.9 L	7.3 kg		GRAY	4	44.60
3552	Rigid Liner fits 8180-88, 8182-88	14 1/2" dia x 30 1/2" h	22 gal	26.9 lb	36.8 cm x 76.5 cm	83.3 L	12.2 kg		GRAY	4	58.00

\* Not for sale in California. \* Provides hands-free product use.

### STEEL CONTAINERS

No.	Description	U.S. Dimensions	U.S. Capacity	U.S. Ship Wt/Ctn	U.S. Liner Capacity	Metric Dimensions	Metric Capacity	Metric Ship Wt/Ctn	Metric Liner Capacity	Color	Pack	**U.S. List Price
9601	Ash/Trash Powder Coated Steel Container, Funnel Top	10 1/2" dia x 27 3/4" h	3.5 gal	15.9 lb	GL 3 gal	25.7 cm x 70.2 cm	13.2 L	7.2 kg	GL 11.4 L	BLA	1	138.00
9606	Ash/Trash Stainless Steel Container, Sand Top	10 1/2" dia x 27 3/4" h	3.5 gal	12.5 lb	GL 3 gal	25.7 cm x 70.2 cm	13.2 L	5.7 kg	GL 11.4 L	SSSTL	1	140.00

GL indicates galvanized liner.

## Classic Smoking Urns and Accessories

Perfect in lobbies and hallways.

- Available with side opening for Class A refuse collection
- One-piece, wall-mounted smoking urn is easy to empty and clean



2583



2585



2586

No.	Description	U.S. Dimensions	U.S. Ship Wt/Ctn	Metric Dimensions	Metric Ship Wt/Ctn	Color	Pack	**U.S. List Price
2583	Classic Smoking Urn, Wall Model Self-Closing Unit	10 1/2" dia x 5 1/2" w x 5" h	2.325 lb	25.4 cm x 13.3 cm x 12.7 cm	1.1 kg	BLA	1	107.00
2585	Smoking Urn with Metal Ashtray Top	11 1/2" dia x 19 1/2" h	8.36 lb	29.2 cm x 49.5 cm	3.8 kg	BLA	1	67.60
2586	Smoking Urn, Ash/Trash with Metal Ashtray Top and Metal Liner	12 1/2" dia x 19 1/2" h	9.68 lb	31.8 cm x 49.5 cm	4.4 kg	BLA	1	119.50

### ACCESSORIES

No.	Description	U.S. Dimensions	U.S. Ship Wt/Ctn	Metric Dimensions	Metric Ship Wt/Ctn	Color	Pack	**U.S. List Price
2581	Smoking Urn Insert Tray, Round, fits 2582 Base	10 1/2" dia x 2 1/4" h	5.35 lb	27 cm x 5.7 cm	2.4 kg	BLA	4	28.00
2582	Smoking Urn Base, Floor Model	10 1/2" dia x 18" h	10.015 lb	26.4 cm x 45.7 cm	4.5 kg	BLA	4	29.60
2588	Metal Ashtray Top, Round, fits 2585, 2586 Bases	10 1/2" dia x 2 1/4" h	5.815 lb	27 cm x 5.7 cm	2.6 kg	CHRM	4	24.00

## Color Guide

See Product Description for Color Availability

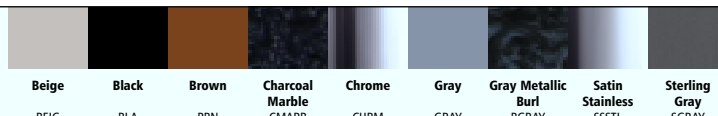

## Landmark Series® Gas Station/Store Front Containers

Style combined with functionality helps make gas islands and store fronts appealing and efficient.

- Integrate waste management and window washing with the Landmark Series® container
- Insert personal messages and advertising with panel frame versions (9W02, 9W03)
- Landmark Series® units include rigid liner (3958)
- Standard bolt-down base for stability
- 9W14 provides an affordable funnel top container for stadiums, retail, education, and hospitality environments
- 9W13 lid also fits 32-gallon BRUTE® containers (2632)

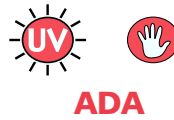

9W03



9W02 / 9W04 / 9W05



9W14



9W02

### PANEL COLORS FOR 9W05 (SOLD SEPARATELY).

Gray Metallic Burl

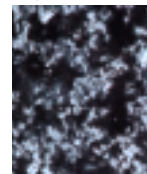

Charcoal Marble



Sterling Gray



Display your own custom insert to promote special messages right at the pump.

No.	Description (w/o Panels)	U.S. Dimensions	U.S. Capacity	U.S. Ship Wt/Ctn	Metric Dimensions	Metric Capacity	Metric Ship Wt/Ctn	Color	Pack	**U.S. List Price
9W00	Landmark Series® Standard Funnel Top	24" l x 24" w x 31" h	35 gal	28.17 lb	60.9 cm x 60.9 cm x 78.7 cm	132.5 L	12.8 kg	BLA	1	226.00
9W01	Landmark Series® Standard Dome Top	24" l x 24" w x 43" h	35 gal	30.97 lb	60.9 cm x 60.9 cm x 109.2 cm	132.5 L	14.0 kg	BLA	1	297.00
9W02	Landmark Series® Funnel Top with Panel Frame and 3958 Rigid Liner	24" l x 24" w x 31" h	35 gal	30.17 lb	60.9 cm x 60.9 cm x 78.7 cm	132.5 L	13.7 kg	BLA	1	302.00
9W03	Landmark Series® Dome Top with Panel Frame and 3958 Rigid Liner	24" l x 24" w x 43" h	35 gal	32.97 lb	60.9 cm x 60.9 cm x 109.2 cm	132.5 L	14.95 kg	BLA	1	374.00
9W12	Light Duty Container Base	22" dia x 28" h	32 gal	45.48 lb	55.9 cm x 71.1 cm	121.1 L	20.63 kg	BLA	6	44.80
9W13	Light Duty Container Lid Fits 9W12, 2632	22½" dia x 2½" h		10.85 lb	56.5 cm x 7 cm		4.92 kg	BLA, GRAY	6	18.00
9W14	Light Duty Container Combo Contains (1) 9W12 and (1) 9W13	22½" dia x 29½" h	32 gal	37.67 lb	57.2 cm x 74.9 cm	121.1 L	17.09 kg	BLA	4	58.20

### PANELS AND ACCESSORIES

No.	Description (w/o Panels)	U.S. Dimensions	U.S. Ship Wt/Ctn	Metric Dimensions	Metric Ship Wt/Ctn	Color	Pack	**U.S. List Price
9W04	Window Wash Kit for 9W00, 9W01, 9W02, 9W03	6¼" l x 16¼" w x 30" h	8.2 lb	15.8 cm x 41.3 cm x 76.1 cm	3.7 kg	BLA	1	131.00
9W05	Decorative Panels for 9W02, 9W03	20" l x 12" w x ¼" h	2.9 lb	50.8 cm x 30.5 cm x .02 cm	1.3 kg	BGRAY, CMARB, SGRAY	1 <sup>^</sup>	138.50
9W06	Pole / Wall Mount Kit for Window Wash Unit		1.7 lb		0.8 kg	BLA	1	49.00

<sup>^</sup> 4 Panels per pack.

## For Other Gas Station/Store Front Containers See:



BRUTE®  
Containers



Plaza®  
Containers



Ranger®  
Containers



Glutton®  
Container



Landmark Series®  
Containers



Marshal®  
Containers

## Medical Waste Step-On Containers

Ideal for areas where medical waste originates, including patient rooms, lab procedure rooms, and emergency rooms.

- Tough, puncture-resistant, all-plastic construction will not crack or leak
- Quiet, heavy-duty pedal for hands-free sanitary use
- Assists in complying with OSHA regulation 29 CFR 1910.1030
- Optional removable rigid liners for better sanitation control



CSFM OSHA



RIGID LINERS  
PAGE 17

Use red with other colors to encourage segregation of waste.



No.	Description	U.S. Dimensions	U.S. Capacity	U.S. Ship Wt/Ctn	Metric Dimensions	Metric Capacity	Metric Ship Wt/Ctn	Can Liners	Color	Pack	**U.S. List Price
6142*	Step-On Container w/Rigid Liner	13 1/4" dia x 15 1/2" h	4 1/2 gal	9.0 lb	33.7 cm x 39.1 cm	17 L	4.1 kg	5002-88*	WHT	1	100.50
6143*	Step-On Container	16 1/2" l x 15 1/2" w x 17 1/2" h	8 gal	7.9 lb	41.3 cm x 40 cm x 43.5 cm	30.3 L	3.6 kg	5004-88*	BEIG, RED, WHT	1	101.50
6144*	Step-On Container	16 1/2" l x 15 1/2" w x 23 1/2" h	12 gal	10 lb	41.3 cm x 40 cm x 60 cm	45.4 L	4.5 kg	5004-88*	BEIG, RED, WHT	1	119.00
6145*	Step-On Container	19 1/2" l x 16 1/2" w x 26 1/2" h	18 gal	13 lb	50.2 cm x 41 cm x 67.3 cm	68.1 L	5.9 kg	5009-88*	BEIG, RED, WHT	1	135.50
6146*	Mobile Step-On Container	19 1/2" l x 16 1/2" w x 32 1/2" h	23 gal	18 lb	50.2 cm x 41 cm x 82.6 cm	87.1 L	8.2 kg	5009-88*	BEIG, RED, WHT	1	193.00

\* Not for sale in California. \* Optional removable liners available on page 17.

## BRUTE® Square Container with Snap-Lock® Lid

Use for central medical waste collection and disposal or in high-volume areas such as operating rooms.

- Collect, transport, and ship regulated medical waste in the same container
- Product SKU 3517 Combo meets DOT #178.603, #178.606, and #178.608 criteria for shipping of solid regulated medical waste
- Indented lid design facilitates stacking during transportation and storage
- Easy-grip handles and molded bottom grips for controlled handling, lifting, and dumping
- Works with 2651-03 BRUTE® Trainable Dolly
- Customizable with BIOHAZARD symbol or your logo



3529



3517 / 2651-03



No.	Description	U.S. Dimensions	U.S. Capacity	U.S. Ship Wt/Ctn	Metric Dimensions	Metric Capacity	Metric Ship Wt/Ctn	Can Liners	Color	Pack	**U.S. List Price
3526	BRUTE® Square Container without Lid	21 1/2" sq x 22 1/2" h	28 gal	59.8 lb	54.6 cm x 57.2 cm	106 L	27.1 kg	5016-88*	GRAY, RED, WHT	6	47.20
3517*	Combo Pack includes 3526 BRUTE® Square Container, 3529 Snap-Lock® Lid	21 1/2" sq x 22 1/2" h	28 gal	74.57 lb	54.6 cm x 57.5 cm	106 L	33.8 kg	5016-88*	RED	6	77.60

\* Not for sale in California. \* Custom imprinting available; contact Rubbermaid Customer Service at (800) 347-9800.

### LIDS AND DOLLIES

No.	Description	U.S. Dimensions	U.S. Capacity	U.S. Ship Wt/Ctn	Metric Dimensions	Metric Capacity	Metric Ship Wt/Ctn	Color	Pack	**U.S. List Price
2646	BRUTE® Tandem Dolly for 2620, 2632, 2643, 2655, 3526, 3536	45" l x 20 1/4" w x 8" h	21 lb	114.3 cm x 51.4 cm x 20.3 cm	9.5 kg	BLA	1	168.50		
2651	BRUTE® Trainable Dolly – 1 Pack	27 1/4" l x 20 3/4" w x 6 3/4" h	12.6 lb	70.8 cm x 51.8 cm x 16.2 cm	5.7 kg	BLA	1	110.50		
2651-03	BRUTE® Trainable Dolly – 3 Pack	27 1/4" l x 20 3/4" w x 6 3/4" h	35.6 lb	70.8 cm x 51.8 cm x 16.2 cm	16.1 kg	BLA	3	326.00		
2652	Pull Handle Accessory for Trainable Dolly	34 1/2" l x 10 1/2" w x 1" h	5.75 lb	87.6 cm x 27.0 cm x 2.5 cm	2.6 kg	BLA	1	50.00		
3529	Snap-Lock® Lid for 3526 Container	22" sq x 2 1/2" h	16.76 lb	55.9 cm x 5.4 cm	7.6 kg	RED	6	30.60		
3530	BRUTE® Square Dolly for 3526, 3536	17 1/2" sq x 6 1/4" h	18.5 lb	43.8 cm x 15.9 cm	8.3 kg	BLA	2	77.20		

## BRUTE® Medical Waste Rollout Containers

Ideal for bulk waste collection and transportation.

- Steel catch bar is compatible with semi-automated lift systems
- Indented lid design facilitates stacking during transportation and storage
- Standard keyed lock provides increased security
- Ships fully assembled, minimizing freight, handling, and assembly costs
- "Lock-back lid" remains against container when opened for better hygiene



Includes locking mechanism.



9W20

No.	Description	U.S. Dimensions	U.S. Capacity	U.S. Ship Wt/Ctn	Metric Dimensions	Metric Capacity	Metric Ship Wt/Ctn	Color	Pack	**U.S. List Price
9W19	BRUTE® Medical Waste Rollout Containers	32 1/2" l x 25 1/2" w x 41 1/2" h	65 gal	30.6 lb	82.0 cm x 64.3 cm x 106.2 cm	246.05 L	13.8 kg	RED	1	270.00
9W20	BRUTE® Medical Waste Rollout Containers	35 1/2" l x 27 1/2" w x 45 1/2" h	95 gal	44.0 lb	89.9 cm x 69.3 cm x 115.8 cm	359.6 L	19.9 kg	RED	1	297.00

### Color Guide

See Product Description for Color Availability

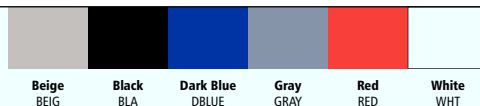

Beige BEIG Black BLA Dark Blue DBLUE Gray GRAY Red RED White WHT

## Recycling Solutions

Rubbermaid Commercial Products has a complete line of recycling containers and sortation options. To start or build upon a recycling program at your facility, keep these tips in mind:

**Place recycling containers as close to the sources of recyclable materials as possible.**

- Rubbermaid offers recycling containers in sizes and shapes to suit both indoor and outdoor applications
- Consider desk side containers for added convenience, as well as large capacity containers to serve as central collection sites

**Provide easily identifiable sortation options.**

- Rubbermaid's recycling solutions include specially designed and color-coded lids and tops for a variety of Rubbermaid containers to make the sortation and collection of recyclable paper, cans, and bottles easier and more efficient
- Containers and lids suitable for use in recycling programs include Mega BRUTE®, BRUTE®, Slim Jim®, Untouchable®, Glutton®, and Plaza®



## Outdoor Station Containers

Large capacity recycling containers suitable for any outdoor environment.

- Easy to recognize "recycling blue"
- All containers (except 3968 and 3969) come standard with the universal recycle symbol
- Increased capacity for high traffic areas
- Glutton® Container (256B-06) accepts two 3540 Slim Jim® Containers (see page 12)



256L / 256B-06

No.	Description	U.S. Dimensions	U.S. Capacity	U.S. Ship Wt/Ctn	Metric Dimensions	Metric Capacity	Metric Ship Wt/Ctn	Color	Pack	**U.S. List Price
256B-06	Glutton® Container	25½" l x 22¾" w x 31½" h	56 gal	67.3 lb	64.8 cm x 57.8 cm x 79.1 cm	212 L	30.5 kg	DBLUE	4	198.00
3968*	Plaza® Container Bottle & Can	24¾" l x 25¼" w x 42½" h	50 gal	78 lb	62.9 cm x 64.1 cm x 107 cm	189.3 L	35.4 kg	DBLUE	1	594.00
3969*	Plaza® Container Paper Recycling	24¾" l x 25¼" w x 42½" h	50 gal	78 lb	62.9 cm x 64.1 cm x 107 cm	189.3 L	35.4 kg	DBLUE	1	594.00
256L	Glutton® Bottle & Can Recycling Top, fits 256B-06	26¾" l x 23" w x 13" h		14.23 lb	67.6 cm x 58.4 cm x 33 cm		6.5 kg	DBLUE	1	233.00

\* Custom imprinting available; contact Rubbermaid Customer Service at (800) 347-9800.

## Recycling Boxes

Collection boxes for use in central locations.

- Recycling boxes are perfect for curbside recycling programs
- Built-in handles for easier lifting and carrying
- Designed to stack or nest
- For use in high-volume paper generation, such as near copiers and printers and in mail rooms



5712-97



5712-06

No.	Description	U.S. Dimensions	U.S. Capacity	U.S. Ship Wt/Ctn	Metric Dimensions	Metric Capacity	Metric Ship Wt/Ctn	Color	Pack	**U.S. List Price
5712-06	Recycling Box with Universal Recycle Symbol	20" l x 15½" w x 13½" h	12½ gal	24.34 lb	50.8 cm x 39.1 cm x 34.3 cm	47.3 L	11 kg	BLUE	6	22.20
5712-97	Recycling Box with "Computer Paper Only" Symbol	20" l x 15½" w x 13½" h	12½ gal	24.34 lb	50.8 cm x 39.1 cm x 34.3 cm	47.3 L	11 kg	BLUE	6	22.20

# 34 WASTE: Recycle Waste

## Deskside Recycling Containers

An easy and effective way to recycle.

- Designed to be used in systems with existing office containers and accessories
- Placed beside traditional wastebaskets, Rubbermaid's Deskside Recycling Containers make it easy to separate recyclable and non-recyclable waste

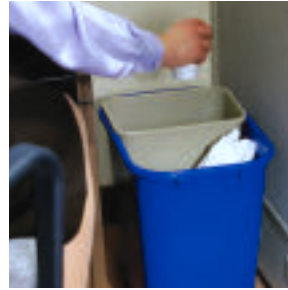

2952 nested in 2956-06 provides space-saving deskside sorting.



2957-06

No.	Description	U.S. Dimensions	U.S. Capacity	U.S. Ship Wt/Ctn	Metric Dimensions	Metric Capacity	Metric Ship Wt/Ctn	Color	Pack	**U.S. List Price
2955-06	Deskside Recycling Container, Small with Universal Recycle Symbol	11 <sup>5/8</sup> " l x 8 <sup>3/4</sup> " w x 12 <sup>1/4</sup> " h	13 <sup>3/4</sup> qt	15.6 lb	28.9 cm x 21 cm x 30.8 cm	12.9 L	7.1 kg	BLUE	12	9.80
2956-06	Deskside Recycling Container, Medium w/Universal Recycle Symbol	14 <sup>5/8</sup> " l x 10 <sup>1/4</sup> " w x 15" h	28 <sup>1/2</sup> qt	22.5 lb	36.5 cm x 26 cm x 38.1 cm	26.6 L	10.2 kg	BLUE	12	10.40
2957-06	Deskside Recycling Container, Large with Universal Recycle Symbol	15 <sup>5/8</sup> " l x 11" w x 19 <sup>1/4</sup> " h	41 <sup>1/4</sup> qt	29.35 lb	38.7 cm x 27.9 cm x 50.5 cm	39 L	13.3 kg	BLUE	12	20.00

## Indoor Station Containers and Tops

For use in high-volume areas.

- Station containers serve as a convenient central collection sites for multiple work stations
- All containers come standard with the universal recycle symbol imprint



3540-06



2791 / 3959-06



2794 / 3959-06



No.	Description	U.S. Dimensions	U.S. Capacity	U.S. Ship Wt/Ctn	Metric Dimensions	Metric Capacity	Metric Ship Wt/Ctn	Color	Pack	**U.S. List Price
3520-06	Half Round Recycling Container	21" l x 11" w x 28" h	21 gal	30.11 lb	53.3 cm x 27.9 cm x 71.1 cm	79.5 L	13.7 kg	BLUE	4	81.40
3540-06	Slim Jim® Recycling Container	20" l x 11" w x 30" h	23 gal	32.87 lb	50.8 cm x 27.9 cm x 76.2 cm	87.1 L	14.9 kg	BLUE	4	60.20
3568-06	Square Recycling Container	14 <sup>1/2</sup> " sq x 24" h	19 gal	24.93 lb	36.8 cm x 61 cm	71.9 L	11.3 kg	BLUE	4	63.60
3569-06	Square Recycling Container	14 <sup>1/2</sup> " sq x 28" h	23 gal	29.34 lb	36.8 cm x 71.1 cm	87.1 L	13.3 kg	BLUE	4	67.00
3958-06	Square Recycling Container	19 <sup>1/2</sup> " sq x 27 <sup>1/4</sup> " h	35 gal	39.425 lb	49.5 cm x 70.2 cm	132.5 L	17.9 kg	DBLUE	4	108.00
3959-06	Square Recycling Container	19 <sup>1/2</sup> " sq x 34 <sup>1/4</sup> " h	50 gal	53.89 lb	49.5 cm x 87 cm	189.3 L	24.4 kg	DBLUE	4	150.00

### TOPS

No.	Description	U.S. Dimensions	U.S. Ship Wt/Ctn	Metric Dimensions	Metric Ship Wt/Ctn	Color	Pack	**U.S. List Price
2673	Slim Jim® Untouchable® Swing Top, fits 3540, 3541, 3554 Containers	20 <sup>5/8</sup> " l x 11 <sup>1/2</sup> " w x 4 <sup>3/4</sup> " h	10.175 lb	51.8 cm x 28.9 cm x 12.1 cm	4.6 kg	BRN, BLUE, GRAY	4	37.80
2688-88	Slim Jim® Handle Top fits 3540, 3541, 3554 Containers	20 <sup>5/8</sup> " l x 11 <sup>1/2</sup> " w x 2 <sup>3/4</sup> " h	4.71 lb	51.8 cm x 28.7 cm x 7 cm	2.1 kg	LGRAY	4	38.80
2689	Untouchable® Top, Square, fits 3568, 3569 Containers	14 <sup>1/2</sup> " sq x 4 <sup>1/2</sup> " h	12.97 lb	37.8 cm x 11.4 cm	5.9 kg	BEIG, BRN, BLUE, GRAY	4	29.80
2692-88	Slim Jim® Bottle & Can Recycling Top, fits 3540, 3541, 3554 Containers	20 <sup>5/8</sup> " l x 11 <sup>1/2</sup> " w x 2 <sup>3/4</sup> " h	3.92 lb	51.8 cm x 28.7 cm x 7 cm	1.8 kg	BRN, GRN	4	38.80
2703-88	Slim Jim® Paper Recycling Top, fits 3540, 3541, 3554 Containers	20 <sup>5/8</sup> " l x 11 <sup>1/2</sup> " w x 2 <sup>3/4</sup> " h	4.13 lb	51.8 cm x 28.7 cm x 7 cm	1.9 kg	BLUE	4	38.80
2791	Untouchable® Bottle & Can Recycling Top, fits 3958-06, 3959-06 Containers	20 <sup>1/2</sup> " sq x 6 <sup>1/4</sup> " h	28.18 lb	51.1 cm x 15.9 cm	12.8 kg	DBLUE	4	58.40
2794	Untouchable® Paper Recycling Top, fits 3958-06, 3959-06 Containers	20 <sup>1/2</sup> " sq x 6 <sup>1/4</sup> " h	28.18 lb	51.1 cm x 15.9 cm	12.8 kg	DBLUE	4	58.40

### Color Guide

See Product Description for Color Availability



Beige BEIG Black BLA Blue BLUE Brown BRN Dark Blue DBLUE Gray GRAY Light Gray LGRAY Green GRN



## Mobile Collection Equipment

Easy to maneuver.

- Can serve as central collection containers or shipping containers, reducing the amount of handling
- Heavy-duty wheels roll easily, even over steps or curbing
- Transport recyclable waste with ease and efficiency
- Dollies sold separately (see page 9)
- Containers come standard with the universal recycle symbol imprint (except 9W21 and 9W22)



4616-06



3536-06 / 3530



2634-06



Use up to three separate BRUTE® containers on a BRUTE® Trainable Dolly to provide an improved recycling solution.

### BRUTE® RECYCLING CONTAINERS

No.	Description	U.S. Dimensions	U.S. Capacity	U.S. Ship Wt/Ctn	Metric Dimensions	Metric Capacity	Metric Ship Wt/Ctn	Color	Pack	**U.S. List Price
2620-06	BRUTE® Recycling Container without Lid	19½" dia x 22¾" h	20 gal	34.95 lb	49.5 cm x 58.1 cm	75.7 L	15.9 kg	BLUE	6	32.20
2632-06	BRUTE® Recycling Container without Lid	22" dia x 27¼" h	32 gal	49.45 lb	55.9 cm x 69.2 cm	121.1 L	22.4 kg	BLUE	6	41.00
2634-06	BRUTE® Mobile office paper collection container	22" dia x 32¼" h	32 gal	86.90 lb	55.9 cm x 81.9 cm	121.1 L	39.42 kg	BLUE	6	101.00
2643-06	BRUTE® Recycling Container without Lid and Dolly	24" dia x 31¼" h	44 gal	52.25 lb	61 cm x 80 cm	166.5 L	23.7 kg	BLUE	4	64.00
3536-06	BRUTE® Square Recycling Container without Lid	23¾" sq x 28¾" h	40 gal	57.13 lb	59.7 cm x 73 cm	151.4 L	25.9 kg	BLUE	4	67.00

### BRUTE® DOLLIES

No.	Description	U.S. Dimensions	U.S. Capacity	U.S. Ship Wt/Ctn	Metric Dimensions	Metric Capacity	Metric Ship Wt/Ctn	Color	Pack	**U.S. List Price
2640	BRUTE® Dolly for 2620, 2632, 2643, 2655 Containers	18½" dia x 6¾" h		13.1 lb	46.4 cm x 16.8 cm		5.9 kg	BLA	2	66.20
2646	BRUTE® Tandem Dolly for 2620, 2632, 2643, 2655, 3526, 3536	45" l x 20¼" w x 8" h		21 lb	114.3 cm x 51.4 cm x 20.3 cm		9.5 kg	BLA	1	168.50
3530	BRUTE® Square Dolly for 3526, 3536 Containers	17¼" sq x 6¼" h		18.5 lb	43.8 cm x 15.9 cm		8.3 kg	BLA	2	77.20
2651	BRUTE® Trainable Dolly – 1 Pack	27¾" l x 20¾" w x 6¾" h	250 lb	12.6 lb	70.8 cm x 51.8 cm x 16.2 cm		5.7 kg	BLA	1	110.50
2651-03	BRUTE® Trainable Dolly – 3 Pack	27¾" l x 20¾" w x 6¾" h	250 lb	35.6 lb	202.4 cm x 51.8 cm x 16.2 cm		16.1 kg	BLA	3/pk	326.00
2652	Pull Handle Accessory	34½" l x 10¾" w x 1" h	N/A	5.75 lb	87.6 cm x 27.0 cm x 2.5 cm		2.6	BLA	1	50.00

### BRUTE® RECYCLING ROLLOUT CONTAINERS

No.	Description	U.S. Dimensions	U.S. Capacity	U.S. Ship Wt/Ctn	Metric Dimensions	Metric Capacity	Metric Ship Wt/Ctn	Color	Pack	**U.S. List Price
9W21	BRUTE® Recycling Rollout Containers	32.3" l x 25.3" w x 41.8" h	65 gal	25.6 lb	82.0 cm x 64.3 cm x 106.2 cm	246.05 L	11.6 kg	BLUE	1	214.00
9W22	BRUTE® Recycling Rollout Containers	35.4" l x 27.3" w x 45.6" h	95 gal	36.0 lb	89.9 cm x 69.3 cm x 115.8 cm	359.6 L	16.3 kg	BLUE	1	243.00
9W27-06	BRUTE® Recycling Rollout Containers, with Lid	29.2" l x 23.4" w x 37.1" h	50 gal	43.6 lb	74.1 cm x 59.4 cm x 94.2 cm	189.3 L	17.2 kg	BLUE	2	135.50

### BULK COLLECTION RECYCLING CONTAINERS

No.	Description	U.S. Dimensions	U.S. Capacity	U.S. Size	U.S. Ship Wt/Ctn	Metric Dimensions	Metric Capacity	Metric Size	Metric Ship Wt/Ctn	Color	Pack	**U.S. List Price
1305-06	Tilt Truck, Standard Duty	60½" l x 28" w x 38¾" h	850 lb	½ cu yd	77 lb	153.7 cm x 71.1 cm x 98.1 cm	385.6 kg	.4 m³	34.9 kg	BLUE	1	910.00
4616-06	Cube Truck	43¾" l x 31" w x 37" h	500 lb	16 cu ft	51 lb	111.1 cm x 78.7 cm x 94 cm	226.8 kg	.5 m³	23.1 kg	BLUE	1	538.00

## Can Liners

High quality can liners for a variety of applications.

- Strong "star seal" bottom eliminates gaps along the seal where leaks can occur
- Easily conforms to the shape of the container
- Distributes refuse weight evenly inside the liner
- Topside dual-dispensing packaging allows for top or side dispensing



STAR SEAL BOTTOM

## Applications

### HIGH DENSITY

- Restaurants
- Office paper
- Construction
- Parks/stadiums

### LINEAR LOW DENSITY

- Janitorial
- Housekeeping
- Everyday use
- Schools

### HIGH DENSITY CORELESS ROLL CAN LINERS

No.	Fits:	U.S. Dimensions	U.S. Size	U.S. Capacity	U.S. Ship Wt/Ctn	Metric Dimensions	Metric Size	Metric Capacity	Metric Ship Wt/Ctn	Color	Pack	**U.S. List Price
5076	55 gal (208.2 L) drum	36" w x 60" l	72" cir	55 gal	20.2 lb	91.4 cm x 152.4 cm	182.8 cm	208.2 L	9.1 kg	CLR	1/200 pcs	80.00
5079	256B, 256B-06, 2655, 3536, 9W27, 9W27-06	43" w x 49" l	86" cir	45-56 gal	18.6 lb	109.2 cm x 124.5 cm	218.4 cm	170-211 L	8.4 kg	CLR	1/200 pcs	96.60

Materials comply with USDA & FDA regulations for food contact.

### LINEAR LOW DENSITY CAN LINERS

No.	Fits:	U.S. Dimensions	U.S. Size	U.S. Capacity	U.S. Ship Wt/Ctn	Metric Dimensions	Metric Size	Metric Capacity	Metric Ship Wt/Ctn	Color	Pack	**U.S. List Price
5002-88 <sup>a</sup>	2952, 2955, 2956, 6142	21 <sup>1</sup> / <sub>2</sub> " w x 24" l	43" cir	6 gal	29.6 lb	54.6 cm x 61.0 cm	109.2 cm	22.7 L	13.4 kg	CLR	1/1000 pcs	164.50
5003-88 <sup>a</sup>	2610, 2947, 2957, 3071-20	23 <sup>3</sup> / <sub>4</sub> " w x 30" l	47 <sup>1</sup> / <sub>2</sub> " cir	11 gal	20.3 lb	60.3 cm x 76.2 cm	120.6 cm	41.6 L	9.2 kg	CLR	1/500 pcs	117.50
5004-88 <sup>a</sup>	3546, 8160-88, 8184-88, 8185-88, 6143, 6144, 6177	24 <sup>1</sup> / <sub>2</sub> " w x 38 <sup>3</sup> / <sub>4</sub> " l	49" cir	22 gal	20.2 lb	62.2 cm x 98.4 cm	124.4 cm	83.3 L	9.2 kg	GRAY	1/300 pcs	159.00
5005-88 <sup>a</sup>	3520, 3568, 3569, 7822, 7823, 8170-88, 8180-88, 8182-88, 8185-88	27 <sup>1</sup> / <sub>2</sub> " w x 39" l	55" cir	23 gal	22.7 lb	69.9 cm x 99.1 cm	139.7 cm	87.1 L	10.3 kg	GRAY	1/300 pcs	159.50
5006-88 <sup>a</sup>	2620	30" w x 34" l	60" cir	20 gal	26.3 lb	76.2 cm x 86.4 cm	152.4 cm	75.7 L	12.0 kg	GRAY	1/300 pcs	156.50
5007-88 <sup>a</sup>	2632, 2634, 2632-46, 2632-56	34" w x 39" l	68" cir	32 gal	33.7 lb	86.4 cm x 99.1 cm	172.7 cm	121.1 L	15.3 kg	CLR, GRAY	1/300 pcs	209.00
5008-88 <sup>a</sup>	2641, 2643, 3958, 3959, 9058, 9P90, 2643-46, 2643-56, 9P91, 9651, 9652	37" w x 44" l	74" cir	44-50 gal	27.3 lb	94.0 cm x 111.8 cm	187.9 cm	166.5-189.2 L	12.4 kg	CLR, GRAY	1/200 pcs	181.00
5009-88 <sup>a</sup>	3540, 3541, 3966, 3967, 6145, 6146, 8182-88, 3554, 3542-20	29 <sup>1</sup> / <sub>2</sub> " w x 40" l	58 <sup>1</sup> / <sub>2</sub> " cir	20-32 gal	29.9 lb	74.3 cm x 101.6 cm	148.5 cm	75.7-121.1 L	13.6 kg	GRAY	1/300 pcs	183.50
5010-88 <sup>a</sup>	55 gal (208.2 L) drum	36" w x 60" l	72" cir	55 gal	18.4 lb	91.4 cm x 152.4 cm	182.8 cm	208.2 L	8.4 kg	GRAY	1/100 pcs	131.00
5011-88 <sup>a</sup>	2655	39 <sup>1</sup> / <sub>2</sub> " w x 48" l	79" cir	55 gal	27.0 lb	100.3 cm x 121.9 cm	200.6 cm	208.2 L	12.3 kg	GRAY	1/100 pcs	170.00
5013-88 <sup>a</sup>	256B, 256B-06, 9W27, 9W27-06	43" w x 47" l	86" cir	56 gal	28.7 lb	109.2 cm x 119.4 cm	218.4 cm	212 L	13.0 kg	CLR, GRAY	1/100 pcs	181.00
5016-88 <sup>a</sup>	3517, 3526, 3963, 3964, 3965, 3968, 3969, 3970, 3971, 3972, 3975, 8430, 9171, 9172, 9173	39" w x 42 <sup>1</sup> / <sub>2</sub> " l	78" cir	45 gal	28.3 lb	99.1 cm x 108.0 cm	198.1 cm	170.3 L	12.9 kg	GRAY	1/200 pcs	181.00
5028-88 <sup>a</sup>	50 gal (189.3 L) container 9W27, 9W27-06	45" w x 47" l	90" cir	50 gal	30.0 lb	114.3 cm x 119.4 cm	228.6 cm	189.3 L	13.6 kg	GRAY	1/100 pcs	156.00

<sup>a</sup> Not for sale in California.

## Color Guide

See Product Description for Color Availability



Clear  
CLR



Gray  
GRAY



# Material Handling

## TOOL ORGANIZATION & TRANSPORT

TradeMaster® Mobile Cabinets & Work Centers .....	38
5-Drawer Mobile Work Center .....	38
TradeMaster® Professional Contractor's Cart .....	39
Trades Carts.....	39

## UTILITY & SERVICE CARTS

Ladder Cart.....	40
Heavy-Duty Utility/Service Carts.....	41
Flat Shelf Carts .....	42
Utility/Service Carts.....	43
Xtra™ Carts .....	44

## MEDIA MASTER® AUDIO-VISUAL CARTS

Media Master® Audio-Visual Carts.....	45
---------------------------------------	----

## SHELVING

Shelving Systems.....	46
Triple® Trolley.....	46

## RESTOCKING TRUCKS

StockMate® Restocking Trucks.....	47
Heavy-Duty Polyethylene Dollies.....	47

## PLATFORM TRUCKS

Platform Trucks .....	48
Heavy-Duty Platform Trucks & Wagons.....	49
Heavy-Duty Platform Convertible Wagon.....	49

## TRACTOR CARTS & FARM CARTS

Heavy-Duty Tractor Carts .....	50
Big Wheel® Carts .....	50
Heavy-Duty Big Wheel® Cart.....	51

## WHEELBARROWS & LAWN CARTS

Contractor Wheelbarrows .....	51
Utility Lawn Carts .....	51

## TILT TRUCKS

Structural Foam Tilt Trucks .....	52
Tilt Trucks .....	53
Heavy-Duty Towable Tilt Trucks.....	53
Forkliftable Tilt Trucks .....	53
Tilt Truck Lids.....	55

Self-Dumping Hoppers.....	55
Cube Trucks .....	56
Heavy-Duty Utility Trucks .....	56
Lids for Cube Trucks & Heavy-Duty Utility Trucks.....	56

## CUBE TRUCKS

Cube Trucks .....	56
Heavy-Duty Utility Trucks.....	56

## CUBE TRUCKS & STORAGE CONTAINERS

Lids for Cube Trucks & Heavy-Duty Utility Trucks.....	57
BRUTE® Totes.....	57
Stack & Nest Palletote® Boxes.....	57
ActionPacker® Storage Containers.....	58
Tool Boxes .....	58

## STOCK TANKS & TACK BOX

Structural Foam Stock Tanks.....	59
Structural Foam Tack Box with Padded Top...59	59

## TradeMaster® Mobile Cabinets & Work Centers

Easily transport tools and supplies where you need them.

- Features locking cabinet doors and 4" deep drawers for versatile tool and supply storage and organization
- All carts include a 3-outlet power strip with cord wrap (UL/CSA listed)
- Drawers feature commercial quality, ball bearing slides
- User-friendly handle provides comfortable, easy maneuverability
- Non-marking 5" casters include two swivel casters with "full lock" ability
- Metal reinforced structural foam shelves engineered for durability
- Arrives 90% assembled



4513-88

ACCESSORIES  
PAGE 39

**FREE!**



Free Quick Change Retractable Utility Knife (9H06, see pg. 110) with each Cabinet and Work Center purchase. Through June 30, 2007, or while supplies last.



4512-88



4513-88



4533-88

No.	Description	U.S. Dimensions	U.S. Capacity	U.S. Ship Wt/Ctn	Metric Dimensions	Metric Capacity	Metric Ship Wt/Ctn	Color	Pack	**U.S. List Price
4512-88	2-Door Cabinet, Small	41 1/4" l x 18 1/4" w x 38 3/8" h	500 lb	57.06 lb	105.7 cm x 46.4 cm x 97.5 cm	226.8 kg	25.9 kg	BLA	1	504.00
4513-88	4-Drawer Cart	40 7/8" l x 18 3/4" w x 38 3/8" h	500 lb	86.87 lb	103.2 cm x 46.7 cm x 97.5 cm	226.8 kg	39.4 kg	BLA	1	700.00
4532-88	2-Door Cabinet, Large	49" l x 26 1/4" w x 38 1/2" h	750 lb	83.76 lb	124.5 cm x 66.7 cm x 97.2 cm	340.2 kg	38.0 kg	BLA	1	694.00
4533-88	4-Drawer & Cabinet, Small	49" l x 26 1/4" w x 38" h	750 lb	122.98 lb	124.5 cm x 66.7 cm x 96.5 cm	340.2 kg	55.8 kg	BLA	1	912.00
4548-88	4-Drawer & Cabinet, Large	58 3/4" l x 26 1/4" w x 38 3/4" h	750 lb	126.51 lb	148.9 cm x 67 cm x 97.2 cm	340.2 kg	57.4 kg	BLA	1	1,050.00

## 5-Drawer Mobile Work Center

Heavy-duty work surface supports up to 250 lbs.

- Built-in cord wrap provides neat, convenient storage of power tools and work lights
- Casters allow easy maneuverability and are lockable for safety
- Locking bar provides security and keeps drawers from sliding open during transport
- Pegboard side panels provide convenient tool organization



**FREE!**



Free Quick Change Retractable Utility Knife (9H06, see pg. 110) with each Work Center purchase. Through June 30, 2007, or while supplies last.



7734-88

No.	Description	U.S. Dimensions	U.S. Capacity	U.S. Ship Wt/Ctn	Metric Dimensions	Metric Capacity	Metric Ship Wt/Ctn	Color	Pack	**U.S. List Price
7734-88	5-Drawer Mobile Work Center	32 1/2" l x 19 1/4" w x 33 1/2" h	250 lb	69 lb	82.9 cm x 50.6 cm x 85.1 cm	113.4 kg	31.3 kg	BLA	1	402.00

### Color

See Product Description for Color Availability



Black  
BLA

No Color  
0000

## TradeMaster® Professional Contractor's Cart

An ideal mobile workstation for electricians, tradesmen, and maintenance professionals.

- Industrial strength molded structural foam won't dent, rust, or need painting
- Convenient flat, hinged work surface top
- Multi-configuration divided compartment tray for small parts
- Raised user-friendly handle reduces wrist and back strain
- Molded-in storage compartments and cup holder
- Non-marking 5" casters with full-locking mechanisms
- 3-outlet, surge protected power strip with 10' cord and wrap (UL/CSA listed)
- Heavy-duty hooks for step ladders and extension cords
- Professional grade ball bearing, full extension drawer slides



4535-88 with top open.

**FREE!**



Free Quick Change Retractable Utility Knife (9H06, see pg. 110) with each Professional Contractor's Cart purchase. Through June 30, 2007, or while supplies last.

No.	Description	U.S. Dimensions	U.S. Capacity	U.S. Ship Wt/Ctn	Metric Dimensions	Metric Capacity	Metric Ship Wt/Ctn	Color	Pack	**U.S. List Price
4535-88	Professional Contractor's Cart	52 1/2" l x 30 3/4" w x 37 1/8" h	500 lb	84.72 lb	133.4 cm x 77.8 cm x 96.2 cm	226.8 kg	38.4 kg	BLA	1	586.00

## Trades Carts

Moves productivity right to the work site—a complete tool storage and mobile workbench system.

- Four compartmentalized boxes for storing assorted parts and hardware
- Fully enclosed, lockable storage compartment helps keep tools and materials secure (6180-88)
- Two storage bins hold essential hand tools and supplies
- Carts move easily over hard surfaces and through elevators and doorways
- Flat surface at user-friendly height provides convenient work area
- Non-marking, 5" casters for easy mobility
- Optional Refuse Bin (3353-88) and Utility Bin (3354-88); see below



**FREE!**



Free Quick Change Retractable Utility Knife (9H06, see pg. 110) with each Trade Cart purchase. Through June 30, 2007, or while supplies last.



6180-88

No.	Description	U.S. Dimensions	U.S. Capacity	U.S. Ship Wt/Ctn	Metric Dimensions	Metric Capacity	Metric Ship Wt/Ctn	Color	Pack	**U.S. List Price
6180	Trades Cart with 5" (12.7 cm) Casters, includes 2 parts boxes and 4 parts bins	38" l x 19 1/2" w x 33 3/4" h	180 lb top shelf, 150 lb bottom shelf	50.305 lb	96.5 cm x 48.9 cm x 84.8 cm	81.6 kg top shelf, 68 kg bottom shelf	22.8 kg	BLA	1	398.00
6180-88	Trades Cart with Locking Cabinet, includes 2 parts boxes and 4 parts bins	38" l x 19 1/2" w x 33 3/4" h	180 lb top shelf, 150 lb bottom shelf	68 lb	96.5 cm x 48.9 cm x 84.8 cm	81.6 kg top shelf, 68 kg bottom shelf	30.8 kg	BLA	1	542.00



4591



4592



3354-88



3353-88

## ACCESSORIES

No.	Description	U.S. Dimensions	U.S. Capacity	U.S. Ship Wt/Ctn	Metric Dimensions	Metric Capacity	Metric Ship Wt/Ctn	Color	Pack	**U.S. List Price
4536	Contractor Top, fits 4532-88, 4533-88, 4534-88	26.5" l x 37.2" w x 4.4" h	150 lb	22.9 lb	67.3 cm x 94.4 cm x 11.2 cm	68 kg	10.4 kg	BLA	1	306.00
4590*	3-Outlet, Surge Protected Power Strip*	13 5/8" l x 2 5/8" w x 2 1/8" h		3.38 lb	34 cm x 6 cm x 5.4 cm		1.5 kg	BLA	1	51.20
4591	Hook Kit (Set of 4)	3" l x 4 3/4" w x 3 3/8" h		3.26 lb	7.6 cm x 12.1 cm x 9.8 cm		1.5 kg	BLA	1	46.40
4592	8" Pneumatic Caster Kit	8.6" l x 4" w x 10" h		25.55 lb	21.8 cm x 10.2 cm x 25.4 cm		11.6 kg	0000	1	312.00
3353-88	Refuse Bin	22" h x 17" w x 12" d	8 gal	9.0 lb	55.9 cm x 43.2 cm x 53.3 cm	30.3 L	4.1 kg	BLA	2	74.20
3354-88	Utility Bin	10 1/2" h x 17" w x 12 1/2" d	4 gal	5.4 lb	26.7 cm x 43.2 cm x 30.8 cm	15.1 L	2.4 kg	BLA	2	35.40

\* UL and CSA listed.

## Ladder Cart

Ladder Cart provides greater mobility, enhanced access, safe ladder handling, and minimal storage requirements.

- Carries a 6' ladder through standard doorways, down halls, and into elevators
- Commercial-grade hybrid construction of powder-coated steel and structural foam holds up to 500 pounds
- Tall profile for a more comfortable work height
- Easily adaptable to work site requirements, including long-item storage, tool holders, and locking cabinets



**FREE!**



Free Quick Change Retractable Utility Knife (9H06, see pg. 110) with each Ladder Cart purchase. Through June 30, 2007, or while supplies last.



**FASTENER CADDY**  
Empty caddy can be flipped over to create a level work surface.



**CONDUIT / PIPE HOLDER**  
Molded handle holds pipe or conduit for clamping and trimming.



**LOCKING STRAP**  
Secure ladders with a simple snap.



**TOOL HOLDER**  
Keeps small tools handy.

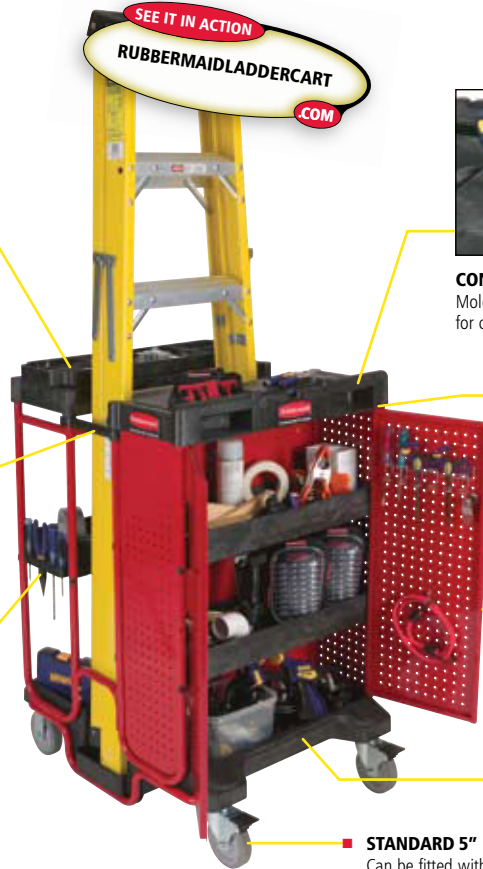

■ **DURABLE STRUCTURAL FOAM CONSTRUCTION**

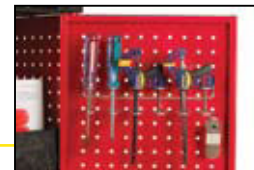

**PERFORATED DOOR & SIDE PANELS**  
Accommodate 1/2" tool hooks on one-inch centers.

■ **DEEP TRAY SHELVES**  
Secure storage for tools and supplies.

■ **STANDARD 5" LOCKING CASTERS**  
Can be fitted with 4592 Pneumatic Casters (Sold Separately).



9T57  
Ladder Cart



9T58  
Ladder Cart with Cabinet

### COMPACT & MANEUVERABLE

Small footprint with unique recessed central ladder storage improves cornering and stability. The 42" working height means less stooping and easier handling. Efficient size for closet storage.

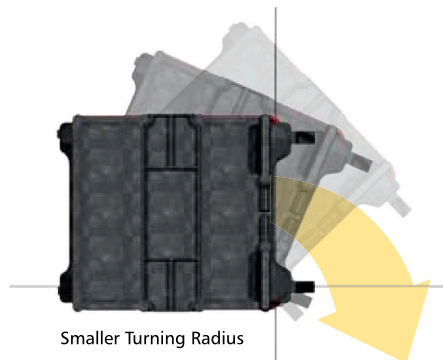

Smaller Turning Radius

No.	Description	U.S. Dimensions	U.S. Capacity	U.S. Ship Wt/Ctn	Metric Dimensions	Metric Capacity	Metric Ship Wt/Ctn	Color	Pack	**U.S. List Price
9T57	Ladder Cart	31 1/2" l x 27 3/4" w x 42 3/4" h	500 lb	69 lb	78.4 cm x 69.5 cm x 108.9 cm	226.8 kg	31.3 kg	BLA	1	554.00
9T58	Ladder Cart with Cabinet	31 1/2" l x 27 3/4" w x 42 3/4" h	500 lb	99 lb	78.4 cm x 69.5 cm x 108.9 cm	226.8 kg	44.9 kg	BLA	1	698.00
4592	8" Pneumatic Caster Kit	8 1/2" l x 4" w x 10" h	N/A	26 lb	21.5 cm x 10.2 cm x 25.4 cm	N/A	11.8 kg	0000	1	312.00

## Color

See Product Description for Color Availability



Beige BEIG    Black BLA    Red RED    No Color 0000

## Heavy-Duty Utility/Service Carts

Perfect for transporting equipment and heavy loads.

- Sturdy structural foam construction won't rust, dent, chip, or peel
- Standard cup holder and storage compartments on top shelf
- Rounded corners help protect walls and furniture
- Lightweight and maneuverable
- 5" diameter, non-marking casters (two fixed and two swivel)
- Two-shelf and three-shelf models available
- Versatile accessories include full and half extension drawers, pneumatic wheels, and bins and hooks



AVAILABLE IN A VARIETY OF CONFIGURATIONS SUITABLE FOR USE IN ANY WORK ENVIRONMENT.



4520-10



4500-88



4530



4531



4520-88

No.	Description	U.S. Dimensions	U.S. Capacity	U.S. Ship Wt/Ctn	Metric Dimensions	Metric Capacity	Metric Ship Wt/Ctn	Color	Pack	**U.S. List Price
9T66 <sup>®</sup>	2 Shelf Utility Cart (4" Casters)	34" l x 16" w x 31 1/2" h	300 lb	362.50 lb	86.3 cm x 40.6 cm x 79.4 cm	136 kg	164.4 kg	BLA	10 <sup>®</sup>	165.50
4500-88	2 Shelf Utility Cart	39 1/4" l x 17 1/4" w x 33 1/4" h	500 lb	31.07 lb	99 cm x 45.4 cm x 84.5 cm	227 kg	14.1 kg	BEIG, BLA	1	216.00
4510	3 Shelf Cart	39 1/4" l x 17 1/4" w x 33 1/4" h	500 lb	37.89 lb	99.7 cm x 45.4 cm x 84.5 cm	227 kg	17.2 kg	BLA	1	269.00
4511	Utility Drawer Cart	39 1/4" l x 17 1/4" w x 33 1/4" h	500 lb	43.69 lb	99.7 cm x 45.4 cm x 84.5 cm	227 kg	19.8 kg	BLA	1	252.00
9T67 <sup>®</sup>	2 Shelf Utility Cart (4" Casters)	40" l x 24" w x 31 1/2" h	300 lb	476.20 lb	101.6 cm x 61 cm x 79.4 cm	136 kg	216.0 kg	BLA	10 <sup>®</sup>	189.00
4520-88	2 Shelf Utility Cart	45 1/4" l x 25 1/4" w x 33 1/4" h	500 lb	44.71 lb	114.9 cm x 65.7 cm x 84.5 cm	227 kg	20.3 kg	BLA	1	245.00
4520-10	2 Shelf Cart w/ Pneumatic Casters	45 1/4" l x 25 1/4" w x 37 1/4" h	500 lb	66.26 lb	114.9 cm x 65.7 cm x 84.5 cm	227 kg	30.1 kg	BLA	1	518.00
4530	3 Shelf Cart	45 1/4" l x 25 1/4" w x 33 1/4" h	500 lb	55.98 lb	114.9 cm x 65.7 cm x 84.5 cm	227 kg	25.4 kg	BLA	1	342.00
4531	Utility Drawer Cart	45 1/4" l x 25 1/4" w x 33 1/4" h	500 lb	56.98 lb	114.9 cm x 65.7 cm x 84.5 cm	227 kg	25.8 kg	BLA	1	326.00
4546	2 Shelf Cart	55" l x 26" w x 33 1/4" h	750 lb	52.37 lb	139.7 cm x 66 cm x 84.5 cm	340 kg	23.8 kg	BLA	1	426.00
4546-10	2 Shelf Cart w/ Pneumatic Casters	55" l x 26" w x 33 1/4" h	750 lb	73.92 lb	139.7 cm x 66 cm x 84.5 cm	340 kg	33.5 kg	BLA	1	688.00
4547	Utility Drawer Cart	55" l x 25 1/4" w x 33 1/4" h	750 lb	64.64 lb	139.7 cm x 64.1 cm x 84.5 cm	340 kg	29.3 kg	BLA	1	504.00

<sup>®</sup> Pallet Pack



4590



4591



4592



4506 or 4593

## ACCESSORIES

No.	Description	U.S. Dimensions	U.S. Ship Wt/Ctn	Metric Dimensions	Metric Ship Wt/Ctn	Color	Pack	**U.S. List Price
3353-88	Refuse Bin 8 Gallon	22" l x 17" w x 12" h	9.0 lb	55.9 cm x 43.2 cm x 30.5 cm	4.1 kg	BLA	2	74.20
3354-88	Utility Bin 4 Gallon	10 1/2" l x 17" w x 12 1/2" h	5.4 lb	26.7 cm x 43.2 cm x 30.8 cm	2.4 kg	BLA	2	35.40
4506	Single Half Extension Drawer (fits 4500-88, 4510)	25" l x 17" w x 4 3/4" h	13.51 lb	63.5 cm x 43.2 cm x 11.7 cm	6.1 kg	RED	1	95.20
4590	3-Outlet, Surge Protected Power Strip	13 3/4" l x 2 3/4" w x 2 1/4" h	3.38 lb	34.0 cm x 6.0 cm x 5.4 cm	1.5 kg	BLA	1	51.20
4591	Hook Kit (Set of 4)	3" l x 4 1/4" w x 3 1/4" h	3.26 lb	7.6 cm x 12.1 cm x 9.8 cm	1.5 kg	BLA	1	46.40
4592	8" Pneumatic Caster Kit	8.6" l x 4" w x 10" h	25.55 lb	21.8 cm x 10.2 cm x 25.4 cm	11.6 kg	0000	1	312.00
4593	Single Full Extension Drawer (fits 4520-88, 4546)	25" l x 17" w x 4 3/4" h	13.51 lb	63.5 cm x 43.2 cm x 11.7 cm	6.1 kg	RED	1	95.20
4597-88	Middle Shelf for 4500-88	30 1/4" l x 16 1/4" w x 3 3/4" h	7.96 lb	78.1 cm x 42.9 cm x 8.6 cm	3.6 kg	BLA	1	103.50
4598-88	Middle Shelf for 4520-88	36 1/4" l x 24 1/4" w x 3 3/4" h	10.61 lb	93.7 cm x 63.2 cm x 8.6 cm	4.8 kg	BLA	1	117.00

**Flat Shelf Carts**

Versatile flat shelves designed to transport oversized, bulky items.

- Sturdy structural foam construction won't rust, dent, chip, or peel
- All-plastic design provides easy maintenance and quiet operation
- Large, non-marking 5" diameter casters reduce touch-up cleaning
- Optional middle shelf available
- Molded-in cord wrap manages extension cords
- Flat top is a convenient work surface



4505



4525

No.	Description	U.S. Dimensions	U.S. Capacity	U.S. Ship Wt/Ctn	Metric Dimensions	Metric Capacity	Metric Ship Wt/Ctn	Color	Pack	**U.S. List Price
4505	Flat Shelf Utility Cart	37 <sup>1</sup> / <sub>2</sub> " l x 19 <sup>1</sup> / <sub>2</sub> " w x 33 <sup>1</sup> / <sub>2</sub> " h	500 lb max cart, 250 lb per shelf	32.922 lb	96.2 cm x 48.7 cm x 84.6 cm	227 kg max cart	14.9 kg	BEIG, BLA	1	230.00
4525	Flat Shelf Utility Cart	43 <sup>1</sup> / <sub>2</sub> " l x 25 <sup>1</sup> / <sub>2</sub> " w x 33 <sup>1</sup> / <sub>2</sub> " h	500 lb max cart, 250 lb per shelf	42.552 lb	111.4 cm x 65.1 cm x 84.6 cm	227 kg max cart	19.3 kg	BLA	1	256.00



3354-88



4594



3353-88

**ACCESSORIES**

No.	Description	U.S. Dimensions	U.S. Capacity	U.S. Ship Wt/Ctn	Metric Dimensions	Metric Capacity	Metric Ship Wt/Ctn	Color	Pack	**U.S. List Price
3353-88	Refuse Bin 8 Gallon	22" l x 17" w x 12" h		9.0 lb	55.9 cm x 43.2 cm x 30.5 cm		4.1 kg	BLA	2	74.20
3354-88	Utility Bin 4 Gallon	10 <sup>1</sup> / <sub>2</sub> " l x 17" w x 12 <sup>1</sup> / <sub>2</sub> " h		5.4 lb	26.7 cm x 43.2 cm x 30.8 cm		2.4 kg	BLA	2	35.40
4594	Shelf for 4505 Utility Cart	37 <sup>1</sup> / <sub>2</sub> " l x 19 <sup>1</sup> / <sub>2</sub> " w	250 lb	9.605 lb	96.2 cm x 48.7 cm	113.5 kg	4.4 kg	BLA, BEIG	1	71.80
4595	Shelf for 4525 Utility Cart	43 <sup>1</sup> / <sub>2</sub> " l x 25 <sup>1</sup> / <sub>2</sub> " w	250 lb	14.5 lb	111.4 cm x 65.1 cm	113.5 kg	6.6 kg	BLA, BEIG	1	84.40

**Color**

See Product Description for Color Availability

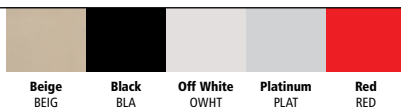

Beige  
BEIG

Black  
BLA

Off White  
OWHT

Platinum  
PLAT

Red  
RED



## Utility/Service Carts

Versatile, durable carts perform a wide variety of tasks.

- Molded shelves won't rust, dent, or require painting
- Plastic construction is easy to clean and minimizes noise
- Convenient handles and compact size enhance maneuverability
- Assists in complying with HACCP guidelines
- Non-marking swivel casters reduce touch-up cleaning



Light-duty utility cart includes 3" swivel casters and aluminum uprights; holds up to 100 lbs.

9T65-71



Light-duty utility cart features back and side panels to conceal contents; holds up to 150 lbs.

3421



Easy-to-clean structural foam construction holds up to 300 lbs; includes molded-in storage on top shelf.

3355-88



3424-88

Stylish utility cart with brushed aluminum uprights and large 4" casters holds up to 200 lbs.



3457

Sturdy utility cart includes a lockable sliding drawer and doors for storage, and back and side panels to conceal contents; holds up to 200 lbs.

No.	Description	U.S. Dimensions	U.S. Capacity	U.S. Ship Wt/Ctn	Metric Dimensions	Metric Capacity	Metric Ship Wt/Ctn	Color	Pack	**U.S. List Price
9T65-71 <sup>a</sup>	Utility Cart with 3" dia (7.6 cm) Swivel Casters, Brushed Aluminum Uprights	31 1/2" l x 16 1/2" w x 36" h	100 lb	212 lb	80.0 cm x 40.6 cm x 91.4 cm	45.3 kg	96.1 kg	BEIG	6 <sup>b</sup>	197.00
3421	Utility Cart with 3" dia (7.6 cm) Swivel Casters and End Panels	33 3/4" l x 18 3/4" w x 36 3/4" h	150 lb	34 lb	85.4 cm x 47.3 cm x 93 cm	68 kg	15.4 kg	BLA, PLAT	1	214.00
3424-88	Utility Cart with 4" dia (10.2 cm) Swivel Casters, Brushed Aluminum Uprights	33 3/4" l x 18 3/4" w x 37 3/4" h	200 lb	30 lb	85.4 cm x 47.3 cm x 95.9 cm	90.7 kg	13.6 kg	BLA, RED, OWHT, PLAT	1	251.00
3457	Utility Cart w/Lockable Doors, Sliding Drawer and 4" dia (10.2 cm) Swivel Casters	33 3/4" l x 18 3/4" w x 37 3/4" h	200 lb	44.8 lb	85.4 cm x 47.3 cm x 95.9 cm	90.7 kg	20.3 kg	BLA	1	388.00
3355-88 <sup>a</sup>	Utility Cart with Enclosed End Panels	31" l x 18" w x 37 1/2" h	300 lb	37.47 lb	78.7 cm x 45.7 cm x 95.3 cm	136.1 kg	17 kg	PLAT	1	394.00

<sup>a</sup> Certified to NSF Std. #2 (splash zone) and USDA Meat and Poultry Equipment Group Listed.

<sup>b</sup> Pallet Pack

## ACCESSORIES

No.	Description	U.S. Dimensions	U.S. Capacity	U.S. Ship Wt/Ctn	Metric Dimensions	Metric Capacity	Metric Ship Wt/Ctn	Color	Pack	**U.S. List Price
3353-88	Refuse Bin, fits 3355, 3421, 3424-88 Utility Carts	22" h x 17" w x 12" d	8 gal	9 lb	55.9 cm x 43.2 cm x 30.5 cm	30.3 L	4.1 kg	BLA	2	74.20
3354-88	Utility Bin, fits 3355, 3421, 3424-88 Utility Carts	10 1/2" h x 17" w x 12 1/2" d	4 gal	5.4 lb	26.7 cm x 43.2 cm x 30.8 cm	15.1 L	2.4 kg	BLA	2	35.40
3458	Utility Cart Back Panel and Door Kit, fits 3421, 3457			5 lb			2.3 kg	BLA	1	112.50
3459	Utility Sliding Drawer w/Lock, fits 3424-88, 3457, 9T28, 9T29, 9T30, 9T32			3.26 lb			1.5 kg	BLA	1	91.40

**Xtra™ Carts**

Durable and attractive carts storage and transportation for front- and back-of-house applications.

- Aluminum uprights and molded shelves engineered for durability and appearance
- Non-marking 4" swivel casters
- Wide shelves hold a variety of equipment and supplies, up to 300 lbs
- Available with locking doors and enclosure panels; accessories include refuse and utility bins and utility bins



Open-sided cart.



4091

Enclosed end panels



4092

Enclosed on three sides.



4093

Instrument cart includes lockable doors and sliding top drawer.



4094

Equipment cart includes locking doors and side and end panels.



4095

Four-shelf cart provides ample storage for a variety of equipment and supplies.



4096

No.	Description	U.S. Dimensions	U.S. Capacity	U.S. Ship Wt/Ctn	Metric Dimensions	Metric Capacity	Metric Ship Wt/Ctn	Color	Pack	**U.S. List Price
4091	Utility Cart, Open Sided	40 <sup>5</sup> / <sub>16</sub> " l x 20" w x 37 <sup>1</sup> / <sub>16</sub> " h	300 lb	43.4 lb	103.2 cm x 50.8 cm x 96 cm	136.1 kg	19.7 kg	BLA, GRAY, OWHT	1	293.00
4092	Utility Cart, enclosed on 2 Sides	40 <sup>5</sup> / <sub>16</sub> " l x 20" w x 37 <sup>1</sup> / <sub>16</sub> " h	300 lb	45.774 lb	103.2 cm x 50.8 cm x 96 cm	136.1 kg	20.8 kg	OWHT	1	412.00
4093	Utility Cart, enclosed on 3 Sides	40 <sup>5</sup> / <sub>16</sub> " l x 20" w x 37 <sup>1</sup> / <sub>16</sub> " h	300 lb	51.63 lb	103.2 cm x 50.8 cm x 96 cm	136.1 kg	23.4 kg	BLA, OWHT	1	472.00
4094	Instrument Cart with Lockable Doors and Sliding Drawer	40 <sup>5</sup> / <sub>16</sub> " l x 20" w x 37 <sup>1</sup> / <sub>16</sub> " h	Max cart: 300 lb	52 lb	103.2 cm x 50.8 cm x 96 cm	Max cart: 136.1 kg	23.6 kg	GRAY	1	472.00
4095	Equipment Cart	40 <sup>5</sup> / <sub>16</sub> " l x 20 <sup>1</sup> / <sub>4</sub> " w x 37 <sup>1</sup> / <sub>16</sub> " h	300 lb	58.45 lb	103.2 cm x 52.7 cm x 96.2 cm	136.1 kg	26.5 kg	BLA	1	514.00
4096	4 Shelf Cart	40 <sup>5</sup> / <sub>16</sub> " l x 20" w x 51" h	300 lb	52 lb	103.2 cm x 50.8 cm x 129.5 cm	136.1 kg	23.6 kg	BLA	1	384.00

**ACCESSORIES**

No.	Description	U.S. Dimensions	U.S. Capacity	U.S. Ship Wt/Ctn	Metric Dimensions	Metric Capacity	Metric Ship Wt/Ctn	Color	Pack	**U.S. List Price
3353-88	Refuse Bin fits 4091, 4092, 4093, 4094, 4095, 4096 Utility Carts	22" h x 17" w x 12" d	8 gal	9 lb	55.9 cm x 43.2 cm x 30.5 cm	30.3 L	4.1 kg	BLA	2	74.20
3354-88	Utility Bin fits 4091, 4092, 4093, 4094, 4095, 4096 Utility Carts	10 <sup>1</sup> / <sub>2</sub> " h x 17" w x 12 <sup>1</sup> / <sub>8</sub> " d	4 gal	5.4 lb	26.7 cm x 43.2 cm x 30.8 cm	15.1 L	2.4 kg	BLA	2	35.40
6199	Utility Drawer w/Lock fits: 4091, 4092, 4093, 4094, 4095, 4096			4.5 lb			2 kg	BRN	1	66.60

**Color**

See Product Description for Color Availability

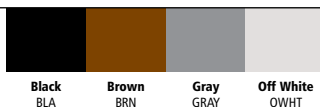

Black BLA    Brown BRN    Gray GRAY    Off White OWHT

## Media Master® Audio-Visual Carts

Audio-visual carts in a variety of sizes and configurations to handle any presentation need.

- Available in 33", 42", and 48" heights
- Cord wrap helps organize wires and cords
- User-friendly handle and four swivel casters for easy maneuverability
- Built-in 3-outlet, surge suppressing power strip (UL/CSA listed)
- Durable and attractive molded shelves and aluminum uprights
- Optional locking cabinet sliding drawer provides extra security



9T35



9T33



9T30



9T29



9T28

No.	Description	U.S. Dimensions	U.S. Capacity	U.S. Ship Wt/Ctn	Metric Dimensions	Metric Capacity	Metric Ship Wt/Ctn	Max TV Size	Color	Pack	**U.S. List Price
9T28*	Audio-Visual Cart, Open Cart w/3 Shelves, 3" dia. (7.6 cm) Casters	32½" l x 18½" w x 32½" h	150 lb	30.14 lb	82.6 cm x 47.3 cm x 81.6 cm	68 kg	13.7 kg	24" diagonal 61 cm diagonal	BLA	1	224.00
9T29*	Audio-Visual Cart, 3 Shelves w/Cabinet, 3" dia. (7.6 cm) Casters	32½" l x 18½" w x 32½" h	150 lb	35.94 lb	82.6 cm x 47.3 cm x 81.6 cm	68 kg	16.3 kg	24" diagonal 61 cm diagonal	BLA	1	372.00
9T30*	Audio-Visual Cart, Open Cart w/3 Shelves, 4" dia. (10.2 cm) Casters	32½" l x 18½" w x 42½" h	200 lb	30.94 lb	82.6 cm x 47.3 cm x 107.6 cm	90.7 kg	14.0 kg	24" diagonal 61 cm diagonal	BLA	1	255.00
9T32*	Audio-Visual Cart, 3 Shelves w/Cabinet, 4" dia. (10.2 cm) Casters	32½" l x 18½" w x 42½" h	200 lb	36.94 lb	82.6 cm x 47.3 cm x 107.6 cm	90.7 kg	16.8 kg	24" diagonal 61 cm diagonal	BLA	1	388.00
9T33*	Audio-Visual Cart, Open Cart w/3 Shelves, 4" dia. (10.2 cm) Casters	36½" l x 20" w x 48½" h	300 lb	42.58 lb	92.7 cm x 50.8 cm x 122.2 cm	136.1 kg	19.3 kg	32" diagonal 81.3 cm diagonal	BLA	1	306.00
9T34*	Audio-Visual Cart, 3 Shelves w/Cabinet, 4" dia. (10.2 cm) Casters	36½" l x 20" w x 48" h	300 lb	51.08 lb	92.7 cm x 50.8 cm x 121.9 cm	136.1 kg	23.2 kg	32" diagonal 81.3 cm diagonal	BLA	1	496.00
9T35*	Audio-Visual Cart, 4 Shelves w/Cabinet, 4" dia. (10.2 cm) Casters	36½" l x 20" w x 48" h	300 lb	61.67 lb	92.7 cm x 50.8 cm x 121.9 cm	136.1 kg	28.0 kg	32" diagonal 81.3 cm diagonal	BLA	1	552.00

\* UL, CSA listed.

3459



6199



### ACCESSORIES

No.	Description	Color	Pack	**U.S. List Price
6199	Utility Sliding Drawer w/Lock, fits 9T33, 9T34, 9T35	BRN	1	66.60
3459	Utility Sliding Drawer, fits 9T28, 9T29, 9T30, 9T32, 3355-88, 3424-88, 3421	BLA	1	91.40

## Shelving Systems

Store, organize, and transport in style with these durable and attractive shelving units.

- Stationary shelves feature molded feet for added stability
- Mobile shelf trucks come with 4" swivel non-marking casters (two with brakes)
- Units are available with four, five, or six shelves and a variety of heights up to 72"
- Cabinet Kit with locking doors is available for several models
- Shelves feature aluminum uprights and steel reinforced molded shelves



9T36



9T37



9T43



9T40

No.	Description	U.S. Dimensions	U.S. Capacity	U.S. Ship Wt/Ctn	Metric Dimensions	Metric Capacity	Metric Ship Wt/Ctn	Color	Pack	**U.S. List Price
9T36	Shelving, 4-Shelf Unit	35½" l x 20" w x 45½" h	800 lb	53.67 lb	89.2 cm x 50.8 cm x 116.5 cm	362.9 kg	24.3 kg	BLA	1	358.00
9T37	Shelving, 5-Shelf Unit	35½" l x 20" w x 60" h	800 lb	66.76 lb	89.2 cm x 50.8 cm x 152.4 cm	362.9 kg	30.3 kg	BLA	1	444.00
9T38	Shelving, 4-Shelf Unit	35½" l x 20" w x 71½" h	800 lb	58.67 lb	89.2 cm x 50.8 cm x 181.3 cm	362.9 kg	26.6 kg	BLA	1	400.00
9T39	Shelving, 5-Shelf Unit	35½" l x 20" w x 71½" h	800 lb	69.06 lb	89.2 cm x 50.8 cm x 181.3 cm	362.9 kg	31.3 kg	BLA	1	502.00
9T40	Shelving, 6-Shelf Unit	35½" l x 20" w x 72¼" h	800 lb	80.76 lb	89.2 cm x 50.8 cm x 184.8 cm	362.9 kg	36.6 kg	BLA	1	620.00
9T41	Cabinet Kit with Doors, Side and Back Panels, fits 9T36, 9T37, 9T40, 9T42			10.25 lb			4.65 kg	BLA, GRAY	1	208.00
9T42	Mobile Shelf Truck, 5-Shelf Mobile Truck w/ 5" dia. (12.7 cm) Casters, 2 w/Locks	35½" l x 20" w x 62¾" h	800 lb	66.96 lb	89.2 cm x 50.8 cm x 158.4 cm	362.9 kg	30.4 kg	BLA	1	562.00
9T43	Mobile Shelf Truck, 4-Shelf Mobile Truck w/ 5" dia. (12.7 cm) Casters, 2 w/Locks	35½" l x 20" w x 72¾" h	800 lb	59.17 lb	89.2 cm x 50.8 cm x 183.2 cm	362.9 kg	26.8 kg	BLA	1	532.00

## Triple® Trolley

Efficiently transports large, bulky loads, then folds flat for easy storage.

- Sturdy structural foam deck won't rust, dent, chip, or peel
- Non-skid platform surface helps prevent load shifting
- Three-position handle lets users push, pull, or fold flat for use as a dolly
- Casters are non-marking



Three-position handle provides better mobility and convenient storage.



4400

No.	Description	U.S. Dimensions	U.S. Capacity	U.S. Ship Wt/Ctn	Metric Dimensions	Metric Capacity	Metric Ship Wt/Ctn	Color	Pack	**U.S. List Price
4400	Triple® Trolley, Utility Duty w/ straight handle and 3" casters.	32½" l x 20½" w	250 lb	20.58 lb	82.6 cm x 52.1 cm	113.4 kg	9.3 kg	BLA	1	139.50
4401	Triple® Trolley, Standard Duty with user-friendly handle and 4" dia. (12.7 cm) x ¾" w (2.22 cm) casters	32½" l x 20½" w	500 lb	25.435 lb	82.6 cm x 52.1 cm	226.8 kg	11.5 kg	BLA	1	168.50
4401-06	Triple® Trolley (2 pack) Straight Handle w/ 4" dia. (12.7 cm.) x ¾" w (2.22 cm) casters	32½" l x 20½" w	500 lb	25.435 lb	82.6 cm x 52.1 cm	226.8 kg	11.5 kg	BLA	6	139.50

## Color

See Product Description for Color Availability

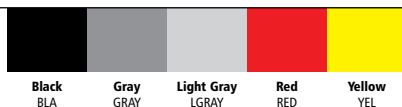

## StockMate® Restocking Trucks

A complete system to transport cartons, stock shelves, manage cardboard, and address aisle safety.

- Ideal for stocking shelves and picking inventory
- Steel reinforced molded structural foam decks won't rust, dent, or require painting
- BoxMate™ Cardboard Management System feature helps keep aisles clear
- Dry erase identification placemark and work surface available on some models
- Up to 1,800 lb load capacity
- Hinged Deck model (9T45) easily converts from full-size to half-size truck
- Wide range of accessories to enhance productivity and safety



9T45 / 9T48 / 3353-88



9T48

### Wire Shelf

Provides additional surface to help organize and transport smaller cartons.



9T45



9T52 / 3353-88



9T56

No.	Description	U.S. Dimensions	U.S. Capacity	U.S. Ship Wt/Ctn	Metric Dimensions	Metric Capacity	Metric Ship Wt/Ctn	Color	Pack	**U.S. List Price
9T45	StockMate® ES Restocking Truck w/ Hinging Deck	63" l x 19 1/2" w x 66 1/4" h	1,800 lb	75.09 lb	160 cm x 48.9 cm x 168.3 cm	816.5 kg	34.1 kg	BLA	1	618.00
9T50	StockMate® Restocking Truck, Standard Deck	63" l x 19 1/2" w x 66 1/4" h	1,800 lb	75.09 lb	160 cm x 48.6 cm x 169.2 cm	816.5 kg	34.1 kg	BLA	1	512.00
9T52	StockMate® Restocking Truck, Standard Deck w/ Cardboard Management System, Polyurethane Wheel and Casters	63" l x 18" w x 64 1/4" h	1,800 lb	84.87 lb	160 cm x 45.7 cm x 163.2 cm	816.5 kg	38.5 kg	BLA	1	564.00
9T56	StockMate® Restocking Truck, Utility Deck, Olefin Wheels and Casters	63" l x 18" w x 64 1/4" h	1,500 lb	84.87 lb	160 cm x 45.7 cm x 163.2 cm	680.4 kg	38.5 kg	BLA	1	350.00

## REFUSE CONTAINERS, ACCESSORIES, AND SAFETY ACCESSORIES

No.	Description	U.S. Dimensions	U.S. Capacity	U.S. Ship Wt/Ctn	Metric Dimensions	Metric Capacity	Metric Ship Wt/Ctn	Color	Pack	**U.S. List Price
3353-88	Refuse Bin	22" h x 17" w x 12" d	8 gal	9.0 lb	55.9 cm x 43.2 cm x 30.5 cm	30.3 L	4.1 kg	BLA	2	74.20
3354-88	Utility Bin	10 1/2" h x 17" w x 12 1/2" d	4 gal	5.4 lb	26.7 cm x 43.2 cm x 30.8 cm	15.1 L	2.4 kg	BLA	2	35.40
3540	Slim Jim® Waste Container	20" l x 11" w x 30" h	23 gal	32.87 lb	50.8 cm x 27.9 cm x 76.2 cm	87.1 L	14.9 kg	BLA, YEL	4	60.20
3541	Slim Jim® Waste Container w/ handles	23 1/2" l x 11" w x 24 1/4" h	15 1/2 gal	24.80 lb	58.7 cm x 27.9 cm x 63.2 cm	60 L	11.2 kg	LGRAY	4	45.60
6112	Floor Sign with Multi-Lingual "Caution" Imprint, 2-Sided	26 1/2" l x 11" w x 1 1/2" d (closed) 26 1/2" l x 11" w x 12" d (open)		15.03 lb	67.3 cm x 27.9 cm x 3.8 cm (closed) 67.3 cm x 27.9 cm x 30.5 cm (open)		6.8 kg	YEL	6	16.60
6114	Floor Sign with Multi-Lingual "Caution" Imprint, 4-Sided	38" l x 12" w x 1 1/2" d (closed) 38" l x 12" w x 16" d (open)		26.90 lb	96.5 cm x 30.5 cm x 3.8 cm (closed) 96.5 cm x 30.5 cm x 40.6 cm (open)		12.2 kg	YEL	6	41.00
4254	Over-The-Spill® Pad Tablet, Contains 25 Pads	15 1/2" l x 14" w		20.00 lb	40 cm x 35.6 cm		9.1 kg	YEL	12	21.60
9T48	StockMate® Wire Shelf	64" l x 15" w x 3" h		4.25 lb	162.6 cm x 38.1 cm x 7.6 cm		1.9 kg	BLA	1	188.50

## Heavy-Duty Polyethylene Dollies

Steel reinforced, molded dollies perform a wide variety of moving tasks.

- Durable, one-piece molded polyethylene decks are lightweight and easy to clean
- Sturdy plastic construction won't rot, mildew, warp, rust, or splinter
- Easy rolling, 4" non-marking swivel casters
- 9T55 features 1" thick rubber pads to protect load and minimize slippage



9T55

9T54

No.	Description	U.S. Dimensions	U.S. Capacity	U.S. Ship Wt/Ctn	Metric Dimensions	Metric Capacity	Metric Ship Wt/Ctn	Color	Pack	**U.S. List Price
9T54	Polyethylene Dolly, Flush Deck	30" l x 18" w	1,000 lb	19.72 lb	76.2 cm x 45.7 cm	453.6 kg	8.9 kg	RED	1	93.00
9T55	Polyethylene Dolly, Padded Deck	30" l x 18" w	1,000 lb	23.73 lb	76.2 cm x 45.7 cm	453.6 kg	10.8 kg	RED	1	110.50

## Platform Trucks

Built for durability and efficient transportation of heavy loads.

- Sturdy structural foam construction won't rust, dent, chip, peel, or splinter—virtually maintenance free
- Wide range of models with capacities from 500 to 2,000 lbs
- Available in one- or two crossbar handle versions
- Pneumatic wheels available on 4466-10 and 4436-10



### 36" L x 24" W

No.	Description	U.S. Dimensions	U.S. Capacity	U.S. Ship Wt/Ctn	Metric Dimensions	Metric Capacity	Metric Ship Wt/Ctn	Color	Pack	**U.S. List Price
4403	Utility Platform Truck, 5" dia x 11/4" wide (12.7 cm x 3.2 cm) rubber casters, crossbar handle	36" l x 24" w	500 lb	58.272 lb	91.4 cm x 61 cm	226.8 kg	26.4 kg	BLA	1	518.00
4406	Standard Platform Truck, 6" dia x 2" wide (15.2 cm x 5.1 cm) rubber casters, crossbar handle	36" l x 24" w	1,000 lb	63.184 lb	91.4 cm x 61 cm	453.6 kg	28.7 kg	BLA	1	612.00

### 48" L x 24" W

No.	Description	U.S. Dimensions	U.S. Capacity	U.S. Ship Wt/Ctn	Metric Dimensions	Metric Capacity	Metric Ship Wt/Ctn	Color	Pack	**U.S. List Price
4433	Utility Platform Truck, 5" dia x 11/4" wide (12.7 cm x 3.2 cm) rubber casters, crossbar handle	48" l x 24" w	500 lb	69.594 lb	121.9 cm x 61 cm	226.8 kg	31.6 kg	BLA	1	564.00
4436	Standard Platform Truck, 6" dia x 2" wide (15.2 cm x 5.1 cm) rubber casters, crossbar handle	48" l x 24" w	1,000 lb	76.328 lb	121.9 cm x 61 cm	453.6 kg	34.6 kg	BLA	1	662.00
4436-04 <sup>A</sup>	Standard USDA Platform Truck, 6" dia x 2" wide (15.2 cm x 5.1 cm) rubber casters, crossbar handle	48" l x 24" w	1,000 lb	76.328 lb	121.9 cm x 61 cm	453.6 kg	34.6 kg	BLA	1	1,012.00
4436-10	Standard Platform Truck, 8" dia (20.3 cm) pneumatic rubber wheels, crossbar handle	48" l x 24" w	1,000 lb	76.328 lb	121.9 cm x 61 cm	453.6 kg	34.6 kg	BLA	1	1,012.00
4436-86	Standard Platform Truck, 6" dia x 2" wide (15.2 cm x 5.1 cm) rubber casters, two crossbar handles	48" l x 24" w	1,000 lb	76.328 lb	121.9 cm x 61 cm	453.6 kg	34.6 kg	BLA	1	856.00
4441	Heavy Duty Platform Truck, 8" dia x 2" wide (20.3 cm x 5.1 cm) polyolefin casters, crossbar handle	48" l x 24" w	2,000 lb	80.945 lb	121.9 cm x 61 cm	907.2 kg	36.7 kg	BLA	1	750.00
4441-04 <sup>A</sup>	Heavy Duty USDA Platform Truck, 8" dia x 2" wide (20.3 cm x 5.1 cm) polyolefin casters, crossbar handle	48" l x 24" w	2,000 lb	80.945 lb	121.9 cm x 61 cm	907.2 kg	36.7 kg	BLA	1	1,106.00

### 60" L x 30" W

No.	Description	U.S. Dimensions	U.S. Capacity	U.S. Ship Wt/Ctn	Metric Dimensions	Metric Capacity	Metric Ship Wt/Ctn	Color	Pack	**U.S. List Price
4461	Utility Platform Truck, 5" dia x 11/4" wide (12.7 cm x 3.2 cm) rubber casters, crossbar handle	60" l x 30" w	500 lb	86.615 lb	152.4 cm x 76.2 cm	226.8 kg	39.3 kg	BLA	1	750.00
4466	Standard Platform Truck, 6" dia x 2" wide (15.2 cm x 5.1 cm) rubber casters, crossbar handle	60" l x 30" w	1,000 lb	87.91 lb	152.4 cm x 76.2 cm	453.6 kg	39.9 kg	BLA	1	800.00
4466-04 <sup>A</sup>	Standard USDA Platform Truck, 6" dia x 2" wide (15.2 cm x 5.1 cm) rubber casters, crossbar handle	60" l x 30" w	1,000 lb	87.91 lb	152.4 cm x 76.2 cm	453.6 kg	39.9 kg	BLA	1	1,070.00
4466-10	Standard Platform Truck, 8" dia (20.3 cm) pneumatic rubber wheels, crossbar handle	60" l x 30" w	1,000 lb	87.91 lb	152.4 cm x 76.2 cm	453.6 kg	39.9 kg	BLA	1	1,070.00
4466-86	Standard Platform Truck, 6" dia x 2" wide (15.2 cm x 5.1 cm) rubber casters, two crossbar handles	60" l x 30" w	1,000 lb	87.91 lb	152.4 cm x 76.2 cm	453.6 kg	39.9 kg	BLA	1	992.00
4471	Heavy Duty Platform Truck, 8" dia x 2" wide (20.3 cm x 5.1 cm) polyolefin casters, crossbar handle	60" l x 30" w	2,000 lb	100.62 lb	152.4 cm x 76.2 cm	907.2 kg	45.6 kg	BLA	1	1,012.00
4471-04 <sup>A</sup>	Heavy Duty USDA Platform Truck, 8" dia x 2" wide (20.3 cm x 5.1 cm) polyolefin casters, crossbar handle	60" l x 30" w	2,000 lb	100.62 lb	152.4 cm x 76.2 cm	907.2 kg	45.6 kg	BLA	1	1,294.00

A quantity of 10 or more platform trucks or any deviation requires 3 weeks lead time.

<sup>A</sup> USDA Meat & Poultry Equipment Group Listed and assists in complying w/HACCP guidelines.

## Color

See Product Description for Color Availability



Black  
BLA

No Color  
0000

## Heavy-Duty Platform Trucks & Wagons

Ideal for moving large, heavy loads—indoors and out.

- Features tough structural foam construction with steel support
- Won't rust, dent, or splinter like some metal and wood trucks
- Rear hitch allows training of several wagons to help reduce multiple trips
- Optional side panel package for increased load capacity



9T09 / 9T12



9T21

No.	Description	U.S. Dimensions	U.S. Capacity	U.S. Ship Wt/Ctn	Metric Dimensions	Metric Capacity	Metric Ship Wt/Ctn	Color	Pack	**U.S. List Price
9T09	Side Panel Package, Converts Truck to Platform Convertible Wagon (fits 9T11, 9T12, 9T21)			55.85 lb			25.3 kg	BLA	1	366.00
9T11	Platform Truck, Crossbar Handle, 6" Rubber Casters	70" l x 40" w	1,000 lb	126.5 lb	177.8 cm x 101.6 cm	453.6 kg	57.4 kg	BLA	1	1,038.00
9T12	Platform Truck, Crossbar Handle, 8" Pneumatic Casters	70" l x 40" w	1,000 lb	126.5 lb	177.8 cm x 101.6 cm	453.6 kg	57.4 kg	BLA	1	1,392.00
9T21	Platform Truck, Crossbar Handle, 8" Polyolefin Casters	70" l x 40" w	2,000 lb	126.5 lb	177.8 cm x 101.6 cm	907.2 kg	57.4 kg	BLA	1	1,312.00

## Heavy-Duty Platform Convertible Wagon

Ideal for transporting heavy or bulky loads in manufacturing, industrial, and groundskeeping settings.

- Structural steel undercarriage supports heavy loads—up to 3,500 lbs
- Structural foam construction resists rust, dents, chipping, and peeling
- Interchangeable handle for pulling by hand or machine
- All wagons come standard with T-Bar handle for pulling by hand



9T07

Wheel options:  
12" (30.5 cm) or 16" (40.6 cm)  
pneumatic wheels.



No.	Description	U.S. Dimensions	U.S. Capacity	US Ship Wt/Ctn	U.S. Load Rating	Metric Dimensions	Metric Capacity	Metric Ship Wt/Ctn	Metric Load Rating	Color	Pack	**U.S. List Price
9T06	Heavy-Duty Platform Convertible Wagon w/16" (40.6 cm) Pneumatic Wheels	40" w x 70" l	20 cu ft	130 lb	3,500 lb	101.6 cm x 177.8 cm	.6m <sup>3</sup>	59 kg	1587.6 kg	BLA	1	1,524.00
9T07	Heavy-Duty Platform Convertible Wagon w/12" (30.5 cm) Pneumatic Wheels	40" w x 70" l	20 cu ft	125 lb	2,000 lb	101.6 cm x 177.8 cm	.6m <sup>3</sup>	56.7 kg	907.2 kg	BLA	1	1,292.00
9T09	Side Panel Package for Heavy-Duty Platform Convertible Wagons 9T06 & 9T07 (4 Sides & 2 Ends)			55.85 lb				25.3 kg		BLA	1	366.00
9T10	Tow Package for Heavy-Duty Platform Convertible Wagon			2.8 lb				1.3 kg		0000	1	94.40

## Heavy-Duty Tractor Carts

Versatile carts to carry almost any load.

- Three sizes to suit a variety of uses
- Smooth, seamless interior makes dumping and cleaning easy
- Heavy-duty structural foam construction for durability
- Oversized pneumatic tires easily maneuver through rough terrain
- Hefty carbon-steel axle helps increase load-bearing effectiveness



5662-61



5663-61

No.	Description	U.S. Dimensions	U.S. Load	U.S. Size	U.S. Ship Wt/Ctn	Metric Dimensions	Metric Load	Metric Size	Metric Ship Wt/Ctn	Color	Pack	** U.S. List Price
5660	10 Cu Ft Tractor Cart (Assembled)	68" l x 35 1/4" w x 29 1/2" h	1,200 lb	10 cu ft	101.7 lb	172.7 cm x 90.1 cm x 74.9 cm	554 kg	.28 m <sup>3</sup>	39.95 kg	BLA	1	462.00
5660-61	10 Cu Ft Tractor Cart (Unassembled)	68" l x 35 1/4" w x 29 1/2" h	1,200 lb	10 cu ft	101.7 lb	172.7 cm x 90.1 cm x 74.9 cm	554 kg	.28 m <sup>3</sup>	45.40 kg	BLA	1	462.00
5662-61	8 Cu Ft Tractor Cart (Unassembled)	60" l x 39 1/4" w x 25" h	400 lb	8 cu ft	62.5 lb	152.4 cm x 99.8 cm x 63.5 cm	181 kg	.226 m <sup>3</sup>	28.38 kg	BLA	1	251.00
5663-61	15 Cu Ft Tractor Cart (Unassembled)	75 1/8" l x 39 1/4" w x 33 1/4" h	1,500 lb	15 cu ft	111.7 lb	192.7 cm x 100.3 cm x 84.3 cm	680 kg	.424 m <sup>3</sup>	36.28 kg	BLA	1	612.00
51566000	Axle for 5660, 5660-61										1	34.60
M1566000	Wheel for 5660, 5660-61										1	73.60
M1566200	Wheel for 5662-61										1	55.20
20566300	Wheel for 5663-61										1	87.40
50566200	Axle for 5662-61										1	27.60
50566300	Axle for 5663-61										1	23.00

## Big Wheel® Carts

Designed for heavy-duty, long-lasting use.

- Smooth, all-plastic, one-piece tub construction is easy to dump and clean
- Large 20" semi-pneumatic wheels roll smoothly over rough surfaces
- 5642 has a weighted load capacity of 200 lbs and holds up to 3.5 cu ft (.09 m<sup>3</sup>) level capacity or 4.0 cu ft (.11 m<sup>3</sup>) heaped capacity
- 5654 has a weighted load capacity of 300 lbs and holds up to 7.5 cu ft (.2 m<sup>3</sup>) level capacity or 8.75 cu ft (.25 m<sup>3</sup>) heaped capacity



5642



5654-61

No.	Description	U.S. Dimensions	U.S. Capacity	U.S. Ship Wt/Ctn	Metric Dimensions	Metric Capacity	Metric Ship Wt/Ctn	Color	Pack	** U.S. List Price
5642	7.5 Cu Ft Big Wheel® Cart (Assembled)	58" l x 32 3/4" w x 28 1/2" h	7.5 cu ft	45.10 lb	147.3 cm x 83.1 cm x 71.8 cm	.21 m <sup>3</sup>	20.45 kg	BLA	1	240.00
5642-10	7.5 Cu Ft Heavy Duty Big Wheel® Cart	57" l x 41" w x 26" h	7.5 cu ft	55.0lb	144.7 cm x 104.1 cm x 66 cm	.21 m <sup>3</sup>	25.0 kg	BLA	1	572.00
5642-61	7.5 Cu Ft Big Wheel® Cart (Unassembled)	58" l x 32 3/4" w x 28 1/2" h	7.5 cu ft	49.3 lb	147.3 cm x 83.1 cm x 71.8 cm	.21 m <sup>3</sup>	22.38 kg	BLA	1	240.00
5654-61	3.5 Cu Ft Big Wheel® Cart (Unassembled)	47" l x 27 1/2" w x 24 3/4" h	3.5 cu ft	38.2 lb	119.3 cm x 69.8 cm x 62.9 cm	.09 m <sup>3</sup>	17.3 kg	BLA	1	233.00
M1564200	Wheel for 5642, 5642-61								1	80.60
M1565400	Wheel for 5654-61								1	59.80
22564210	Wheel for 5642-10								1	71.40
50565400	Axle for 5654-61								1	23.00
52564200	Axle for 5642, 5642-61								1	11.88

## Color

See Product Description for Color Availability



Black  
BLA

Green  
GRN

Platinum  
PLAT



## Heavy-Duty Big Wheel® Cart

Suitable for industrial, commercial, and agricultural work.

- Strong, durable one-piece construction carries up to 700 lbs
- High-flotation, 8" wide wheels provide easy mobility over most surfaces
- Reinforced steel axle for heavy-duty hauling
- Lightweight Low Wheel Cart (5640) carries loads up to 300 lbs across soft or uneven terrain



5642-10



5640-00

No.	Description	U.S. Dimensions	U.S. Capacity	U.S. Ship Wt/Ctn	Metric Dimensions	Metric Capacity	Metric Ship Wt/Ctn	Color	Pack	** U.S. List Price
5640	7.5 Cu Ft Low Wheel Cart (assembled)	58" l x 33½" w x 28½" h	7.5 cu ft	45.8 lb	147.3 cm x 85.8 cm x 71.8 cm	.21 m³	20.5 kg	BLA	1	244.00
5642-10	7.5 Cu Ft Big Wheel® Cart	57" l x 41" w x 26" h	7.5 cu ft	55.0 lb	144.7 cm x 104.1 cm x 66 cm	0.21m³	20.45 kg	BLA	1	572.00
22564210	Wheel for 5642-10								1	71.40
M1564205	Wheel for 5640								1	57.60
50564205	Axle for 5640								1	23.00

## Contractor-Grade Wheelbarrows

Engineered for tough, durable performance.

- Smooth, one piece seamless pan prevents leaking
- Long-lasting hardwood handles for added strength and steady handling
- Durable, oversized pneumatic tire maneuvers easily
- Carries up to 200 lbs



5658-61



5659-61

No.	Description	U.S. Dimensions	U.S. Capacity	U.S. Ship Wt/Ctn	Metric Dimensions	Metric Capacity	Metric Ship Wt/Ctn	Color	Pack	** U.S. List Price
5658-61	6.5 Cu Ft Contractor Wheelbarrow (Unassembled)	60" l x 27" w x 27½" h	6.5 cu ft	50.60 lb	152.4 cm x 68.5 cm x 69.8 cm	.18 m³	23 kg	BLA	1	207.00
5659-61	6.5 Cu Ft Two-Wheel Contractor Wheelbarrow (Unassembled)	60" l x 27" w x 27½" h	6.5 cu ft	57.5 lb	152.4 cm x 68.5 cm x 69.8 cm	.18 m³	26.1 kg	BLA	1	239.00
53565800	Axle for 5658-61								1	23.00
70565900	Axle for 5659-61								1	23.00
925658C1	Axle Retainer for 5658-61								2	15.58
925659C1	Axle Retainer for 5659-61								2	15.58
M1565800	Wheel for 5658-61								1	55.20
M1565900	Wheel for 5659-61								1	73.60
NP565804	Wheelbarrow Handle Kit (2 wood handles) fits 5658 & 5659								1	23.20

## Utility Lawn Carts

Designed to move loads quickly and easily.

- Easy to lift and dump; handle features molded-in tool/beverage holder
- Smooth interior is easy to clean
- 3707 holds up to 3.25 cu ft (.09 m³) level capacity or 4.5 cu ft (.127 m³) heaped capacity
- 3706 holds up to 4.5 cu ft (.127 m³) level capacity or 5.75 cu ft (.16 m³) heaped capacity



3706



3707

No.	Description	U.S. Dimensions	U.S. Capacity	U.S. Ship Wt/Ctn	Metric Dimensions	Metric Capacity	Metric Ship Wt/Ctn	Color	Pack	** U.S. List Price
3706-03	4.5 Cu Ft Roughneck Lawn Cart	48" l x 23½" w x 28" h	4.5 cu ft	46.5 lb	121.9 cm x 59.6 cm x 71.1 cm	.13 m³	21.11 kg	GRN	3	83.00
3706-12	4.5 Cu Ft Roughneck Lawn Cart Pallet	48" l x 23½" w x 28" h	4.5 cu ft	235.9 lb	121.9 cm x 59.6 cm x 71.1 cm	.13 m³	107.1 kg	GRN	12	83.00
3707-03	3.25 Cu Ft Roughneck Lawn Cart	42½" l x 21" w x 28" h	3.25 cu ft	43.99 lb	107.9 cm x 53.3 cm x 71.1 cm	.09 m³	19.95 kg	PLAT	3	58.80
3707-12	3.25 Cu Ft Roughneck Lawn Cart Pallet	42½" l x 21" w x 28" h	3.25 cu ft	195.49 lb	107.9 cm x 53.3 cm x 71.1 cm	.09 m³	88.67 kg	PLAT	12	58.80

## Structural Foam Tilt Trucks

Durable molded trucks handle heavy loads with ease.

- Durability of modern Structural Foam technology
- Ergonomic “steering wheel” Handle
- Non-marking wheels and casters
- Frameless design supports USDA Meat & Poultry Equipment Compliance
- Constant force knee and secondary handle improve dumping control
- Unibody design promotes a more discrete appearance in public areas
- Inset wheels allow for safe operation in tight quarters
- Fits through standard commercial doorways and onto elevators easily
- Optional hinged domed lid available.
- Available in ½, ¾, and 1 cu yd sizes
- Capacities up to 2,100 lbs



Rugged structural foam construction for use in harsh environments.

### Strength and durability

Structural foam molding eliminates the need for a metal frame and provides a seamless, leak-proof body that won't rust, chip, dent, or peel.



9T16

9T22 Lid



Inset wheel position prevents damage to surroundings.

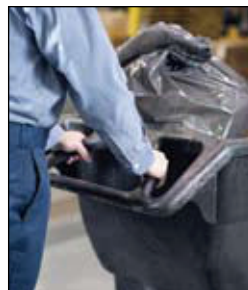

The ergonomically designed handle provides excellent handling and maneuvering.



Secondary handle helps control truck in final dumping position.



Specifically designed for controlled dumping by one person.



Available in sizes from 1/2 to 2 1/2 cubic yards.

## Rotomolded Tilt Trucks

- Manufactured with traditional Rotational Molding technology
- Easy to handle and maneuver
- Forkliftable model fully compatible with forklifts and many automated lifters
- Towable/Trainable models with pneumatic wheels for smooth movement over a variety of surfaces (5MPH maximum)
- USDA, FDA compliant materials
- Optional hinged domed lid available on most models.
- Available in 1/2, 1, 1 1/2, 2 and 2 1/2 cu yd sizes
- Capacities up to 2,300 lbs

## Tilt Trucks

**Durable construction for transporting and dumping heavy loads with ease.**

- Inset wheels on 1/2 and 1 cu yd models protect walls, fixtures, and patrons
- Smooth surface is easy to clean and resists pitting and corroding



1315

## Heavy-Duty Towable Tilt Trucks

**Towable and trainable tilt trucks for heavy-duty use.**

- Heavy-duty tow bar, hitch, and frame for multiple truck towing and training up to 5 mph
- Pneumatic wheels provide smooth movement over rough terrain



1316-41



## Forkliftable Tilt Trucks

- Heavy-duty welded fork pockets allow easy transportation by forklift
- Available in sizes from 1/2 to 1 1/2 cu yds, suitable for a variety of work environments



## 1/2 CUBIC YARD TILT TRUCKS

No.	Description	U.S. Dimensions	U.S. Size	U.S. Capacity	U.S. Ship Wt/Ctn	Metric Dimensions	Metric Size	Metric Capacity	Metric Ship Wt/Ctn	Color	Pack	**U.S. List Price
9T17	Tilt Truck (RM)	56 1/2" l x 28" w x 38 1/2" h	1/2 cu yd	300 lb	138.5 lb	144.1 cm x 71.1 cm x 98.1 cm	0.4 m <sup>3</sup>	136.1 kg	62.8 kg	BLA	3	504.00
9T13	Structural Foam, Utility Duty	57 1/2" l x 26 1/2" w x 33 1/2" h	1/2 cu yd	450 lb	86.9 lb	134.9 cm x 68.2 cm x 86 cm	0.4 m <sup>3</sup>	204.1 kg	39.4 kg	BLA	1	568.00
1304	Tilt Truck, Utility Duty (RM)	56 1/2" l x 28" w x 38 1/2" h	1/2 cu yd	450 lb	62.5 lb	144.1 cm x 71.1 cm x 98.1 cm	0.4 m <sup>3</sup>	204.1 kg	28.3 kg	BLA	1	632.00
9T14	Structural Foam, Standard Duty (RM)	57 1/2" l x 26 1/2" w x 33 1/2" h	1/2 cu yd	850 lb	95.9 lb	134.9 cm x 68.2 cm x 86 cm	0.4 m <sup>3</sup>	385.5 kg	43.5 kg	BLA	1	666.00
1305	Tilt Truck, Standard Duty (RM)	60 1/2" l x 28" w x 38 1/2" h	1/2 cu yd	850 lb	77 lb	153.7 cm x 71.1 cm x 98.1 cm	0.4 m <sup>3</sup>	385.6 kg	34.9 kg	DBLUE, RED, YEL, BLA	1	910.00
1305-06	Tilt Truck, Standard Duty with "We Recycle" Symbol (RM)	60 1/2" l x 28" w x 38 1/2" h	1/2 cu yd	850 lb	77 lb	153.7 cm x 71.1 cm x 98.1 cm	0.4 m <sup>3</sup>	385.6 kg	34.9 kg	BLUE	1	910.00
1305-42	Forkliftable Tilt Truck, Standard Duty (RM)	60 1/2" l x 28" w x 38 1/2" h	1/2 cu yd	850 lb	88 lb	153.7 cm x 71.1 cm x 98.1 cm	0.4 m <sup>3</sup>	385.6 kg	39.9 kg	BLA	1	954.00
1306 <sup>a</sup>	Tilt Truck, Heavy-Duty (RM)	60 1/2" l x 28" w x 38 1/2" h	1/2 cu yd	1,400 lb	88 lb	153.7 cm x 71.1 cm x 98.1 cm	0.4 m <sup>3</sup>	635 kg	39.9 kg	BLA	1	1,060.00
1306-41*	Towable Trainable, Heavy-Duty (RM)	60 1/2" l x 28" w x 38 1/2" h	1/2 cu yd	1,400 lb	92.21 lb	153.7 cm x 71.1 cm x 98.1 cm	0.4 m <sup>3</sup>	635.04 kg	41.82 kg	BLA	1	1,262.00

## 3/4 CUBIC YARD TILT TRUCKS

No.	Description	U.S. Dimensions	U.S. Size	U.S. Capacity	U.S. Ship Wt/Ctn	Metric Dimensions	Metric Size	Metric Capacity	Metric Ship Wt/Ctn	Color	Pack	**U.S. List Price
1011	Structural Foam, Utility Duty	64 1/2" l x 30 1/2" w x 38" h	3/4 cu yd	600 lb	92 lb	163.8 cm x 76.8 cm x 96.5 cm	.6 m <sup>3</sup>	272.1 kg	41.7 kg	BLA	1	714.00
1013	Structural Foam, Standard Duty	64 1/2" l x 30 1/2" w x 38" h	3/4 cu yd	1,000 lb	101 lb	163.8 cm x 76.8 cm x 96.5 cm	.6 m <sup>3</sup>	453.6 kg	45.8 kg	BLA	1	840.00

## 1 CUBIC YARD TILT TRUCKS

No.	Description	U.S. Dimensions	U.S. Size	U.S. Capacity	U.S. Ship Wt/Ctn	Metric Dimensions	Metric Size	Metric Capacity	Metric Ship Wt/Ctn	Color	Pack	**U.S. List Price
9T18	Tilt Truck (RM)	72 1/2" l x 33 1/2" w x 43 1/2" h	1 cu yd	600 lb	259.5 lb	183.5 cm x 85.1 cm x 111.1 cm	0.8 m <sup>3</sup>	272.1 kg	117.7 kg	BLA	3	688.00
1314	Tilt Truck, Utility Duty (RM)	72 1/2" l x 33 1/2" w x 43 1/2" h	1 cu yd	850 lb	111 lb	183.5 cm x 85.1 cm x 111.1 cm	0.8 m <sup>3</sup>	385.6 kg	50.3 kg	BLA	1	856.00
9T15	Structural Foam, Standard Duty	70 1/2" l x 33 1/2" w x 42 1/2" h	1 cu yd	1,250 lb	139.1 lb	179.7 cm x 85.1 cm x 107.3 cm	.8 m <sup>3</sup>	566.9 kg	63.1 kg	BLA	1	962.00
1315	Tilt Truck, Standard Duty (RM)	72 1/2" l x 33 1/2" w x 43 1/2" h	1 cu yd	1,250 lb	111 lb	183.5 cm x 85.1 cm x 111.1 cm	0.8 m <sup>3</sup>	567.0 kg	50.3 kg	DBLUE, RED, YEL, BLA	1	1,172.00
1315-42	Forkliftable Tilt Truck, Standard Duty (RM)	72 1/2" l x 33 1/2" w x 43 1/2" h	1 cu yd	1,250 lb	124 lb	183.5 cm x 85.1 cm x 111.1 cm	.8 m <sup>3</sup>	567.0 kg	56.2 kg	BLA	1	1,228.00
9T16	Structural Foam, Heavy-Duty	70 1/2" l x 33 1/2" w x 42 1/2" h	1 cu yd	2,100 lb	141.1 lb	179.7 cm x 85.1 cm x 107.3 cm	.8 m <sup>3</sup>	952.5 kg	64.0 kg	BLA	1	1,108.00
1316	Tilt Truck, Heavy-Duty (RM)	72 1/2" l x 33 1/2" w x 43 1/2" h	1 cu yd	2,100 lb	120 lb	183.5 cm x 85.1 cm x 111.1 cm	0.8 m <sup>3</sup>	952.5 kg	54.4 kg	BLA	1	1,352.00
1316-41*	Towable Trainable, Heavy-Duty (RM)	72 1/2" l x 33 1/2" w x 43 1/2" h	1 cu yd	2,100 lb	178.0 lb	183.5 cm x 85.1 cm x 111.1 cm	0.8 m <sup>3</sup>	952.6 kg	80.73 kg	BLA	1	1,612.00

## 1 1/2 CUBIC YARD TILT TRUCKS

No.	Description	U.S. Dimensions	U.S. Size	U.S. Capacity	U.S. Ship Wt/Ctn	Metric Dimensions	Metric Size	Metric Capacity	Metric Ship Wt/Ctn	Color	Pack	**U.S. List Price
1025 <sup>a</sup>	Tilt Truck, Standard Duty (RM)	80 1/2" l x 43" w x 49 1/2" h	1 1/2 cu yd	1,200 lb	212 lb	204.5 cm x 109.2 cm x 125.7 cm	1.1 m <sup>3</sup>	544.3 kg	96.2 kg	BLA	1	2,284.00
1025-42 <sup>a</sup>	Forkliftable Tilt Truck, Standard Duty (RM)	80 1/2" l x 43" w x 49 1/2" h	1 1/2 cu yd	1,200 lb	231.5 lb	204.5 cm x 109.2 cm x 125.7 cm	1.1 m <sup>3</sup>	544.3 kg	105 kg	BLA	1	2,398.00
1026 <sup>a</sup>	Tilt Truck, Heavy-Duty (RM)	80 1/2" l x 43" w x 49 1/2" h	1 1/2 cu yd	2,100 lb	213 lb	204.5 cm x 109.2 cm x 125.7 cm	1.1 m <sup>3</sup>	952.5 kg	96.6 kg	BLA	1	2,542.00
1026-41 <sup>a</sup>	Towable Trainable, Heavy-Duty (RM)	80 1/2" l x 43" w x 49 1/2" h	1 1/2 cu yd	2,100 lb	243.76 lb	204.5 cm x 109.2 cm x 125.7 cm	1.1 m <sup>3</sup>	952.5 kg	110.56 kg	BLA	1	3,024.00

## 2 CUBIC YARD TILT TRUCKS

No.	Description	U.S. Dimensions	U.S. Size	U.S. Capacity	U.S. Ship Wt/Ctn	Metric Dimensions	Metric Size	Metric Capacity	Metric Ship Wt/Ctn	Color	Pack	**U.S. List Price
1035 <sup>a</sup>	Tilt Truck, Standard Duty (RM)	81 1/2" l x 46 1/2" w x 50" h	2 cu yd	1,900 lb	215 lb	206.4 cm x 118.7 cm x 127 cm	1.5 m <sup>3</sup>	861.8 kg	97.5 kg	BLA	1	2,694.00
1036 <sup>a</sup>	Tilt Truck, Heavy Duty (RM)	81 1/2" l x 46 1/2" w x 50" h	2 cu yd	2,300 lb	238.5 lb	206.4 cm x 118.7 cm x 127 cm	1.5 m <sup>3</sup>	1043.3 kg	108.2 kg	BLA	1	2,918.00

## 2 1/2 CUBIC YARD TILT TRUCKS

No.	Description	U.S. Dimensions	U.S. Size	U.S. Capacity	U.S. Ship Wt/Ctn	Metric Dimensions	Metric Size	Metric Capacity	Metric Ship Wt/Ctn	Color	Pack	**U.S. List Price
1045 <sup>a</sup>	Tilt Truck, Standard Duty (RM)	81 1/2" l x 55 1/2" w x 50" h	2 1/2 cu yd	1,900 lb	233.5 lb	207 cm x 141 cm x 127 cm	1.9 m <sup>3</sup>	816.8 kg	105.9 kg	BLA	1	2,984.00
1046 <sup>a</sup>	Tilt Truck, Heavy Duty (RM)	81 1/2" l x 55 1/2" w x 50" h	2 1/2 cu yd	2,300 lb	231.4 lb	207 cm x 141 cm x 127 cm	1.9 m <sup>3</sup>	1043.3 kg	105 kg	BLA	1	3,178.00

<sup>a</sup> Requires 3 week lead time and is not returnable.

<sup>b</sup> Custom colors available; contact Rubbermaid Customer Service at (800) 347-9800 for details.

\* Pneumatic Wheels

RM = Rotational Molded

## Color

See Product Description for Color Availability



Black BLA    Dark Blue DBLUE    Red RED    Yellow YEL

## Tilt Truck Lids

Domed, hinged lids provide convenient access to contents without reducing overall capacity.



No.	Description	U.S. Dimensions	U.S. Ship Wt/Ctn	Metric Dimensions	Metric Ship Wt/Ctn	Color	Pack	**U.S. List Price
9T22	Lid for ½ cu yd Structural Foam Tilt Trucks: 9T13 and 9T14	52" l x 27½" w x 9" h	25.25 lb	132.1 cm x 70.8 cm x 22.9 cm	11.45 kg	BLA	1	139.00
1307 <sup>a</sup>	Lid for ½ cu yd Heavy-Duty, Standard Duty and Utility Duty Tilt Trucks: 1304, 1305, 1305-06, 1305-42, 1306, 1306-41, 9T17	56½" l x 28½" w x 9" h	22.3 lb	143.5 cm x 72.4 cm x 22.9 cm	10.1 kg	BLA	1	155.00
1028	Lid for ¾ cu yd Structural Foam Tilt Trucks: 1011, 1013	61" l x 31½" w x 8½" h	24.8 lb	154.9 cm x 80.6 cm x 22.2 cm	11.2 kg	BLA	1	204.00
9T23	Lid for 1 cu yd Structural Foam Tilt Trucks: 9T15 and 9T16	66½" l x 34½" w x 9" h	36.64	169.2 cm x 87.6 cm x 22.9 cm	16.62 kg	BLA	1	189.00
1317 <sup>a</sup>	Lid for 1 cu yd Heavy-Duty, Standard Duty and Utility Duty Tilt Trucks: 1314, 1315, 1315-42, 1316, 1316-41, 9T18	69½" l x 34" w x 8½" h	23.95 lb	176.5 cm x 86.4 cm x 21.6 cm	10.9 kg	BLA	1	211.00
1027	Lid for 1½ cu yd Heavy-Duty and Standard Duty Tilt Trucks: 1025, 1025-42, 1026, 1026-41	82½" l x 44½" w x 3" h	32.8 lb	210.5 cm x 113 cm x 7.6 cm	14.9 kg	BLA	1	480.00

## Self-Dumping Hoppers

Large capacity hoppers store and dump heavy loads with ease.

- Forklift compatible for elevated dumping
- Tilts a full 30° below horizontal to ensure complete dumping
- Pull-release safety latch prohibits premature dumping
- Rugged, functional plastic body positioned on heavy-duty metal frame
- Resists rusting, denting, and pitting that can affect metal hoppers
- Mobile models use four 6" polyolefin casters
- Optional lid available for 1064 models



### ½ CUBIC YARD TILT TRUCKS

No.	Description	U.S. Dimensions	U.S. Size	U.S. Capacity	U.S. Ship Wt/Ctn	Metric Dimensions	Metric Size	Metric Capacity	Metric Ship Wt/Ctn	Color	Pack	**U.S. List Price
1054	Self-Dumping Hopper	55" l x 26½" w x 40" h	½ cu yd	750 lb	194 lb	139.7 cm x 66.7 cm x 101.6 cm	.4 m <sup>3</sup>	340.2 kg	88 kg	BLA	1	1,706.00
1054-43	Mobile Self-Dumping Hopper	55" l x 26½" w x 47½" h	½ cu yd	750 lb	212 lb	139.7 cm x 66.7 cm x 121 cm	.4 m <sup>3</sup>	340.2 kg	96.2 kg	BLA	1	2,060.00

### 1 CUBIC YARD TILT TRUCKS

No.	Description	U.S. Dimensions	U.S. Size	U.S. Capacity	U.S. Ship Wt/Ctn	Metric Dimensions	Metric Size	Metric Capacity	Metric Ship Wt/Ctn	Color	Pack	**U.S. List Price
1059	Self-Dumping Hopper	71½" l x 31½" w x 44½" h	1 cu yd	1,000 lb	230 lb	181.6 cm x 79.4 cm x 114 cm	.8 m <sup>3</sup>	453.6 kg	104.3 kg	BLA	1	1,984.00
1059-43	Mobile Self-Dumping Hopper	71½" l x 31½" w x 52½" h	1 cu yd	1,000 lb	247 lb	181.6 cm x 79.4 cm x 133.4 cm	.8 m <sup>3</sup>	453.6 kg	112 kg	BLA	1	2,364.00

### 1½ CUBIC YARD TILT TRUCKS

No.	Description	U.S. Dimensions	U.S. Size	U.S. Capacity	U.S. Ship Wt/Ctn	Metric Dimensions	Metric Size	Metric Capacity	Metric Ship Wt/Ctn	Color	Pack	**U.S. List Price
1064 <sup>a</sup>	Self-Dumping Hopper	83½" l x 42½" w x 49½" h	1½ cu yd	1,000 lb	307 lb	212.4 cm x 108.9 cm x 124.8 cm	1.1 m <sup>3</sup>	453.6 kg	139.3 kg	BLA	1	2,860.00
1064-43 <sup>a</sup>	Mobile Self-Dumping Hopper	83½" l x 42½" w x 56½" h	1½ cu yd	1,000 lb	360.5 lb	212.4 cm x 108.9 cm x 142.9 cm	1.1 m <sup>3</sup>	453.6 kg	163.5 kg	BLA	1	3,362.00

### 2 CUBIC YARD TILT TRUCKS

No.	Description	U.S. Dimensions	U.S. Size	U.S. Capacity	U.S. Ship Wt/Ctn	Metric Dimensions	Metric Size	Metric Capacity	Metric Ship Wt/Ctn	Color	Pack	**U.S. List Price
1069 <sup>a</sup>	Self-Dumping Hopper	83½" l x 46" w x 49½" h	2 cu yd	1,000 lb	303.2 lb	213 cm x 116.8 cm x 125.7 cm	1.5 m <sup>3</sup>	453.6 kg	137.5 kg	BLA	1	3,052.00
1069-43 <sup>a</sup>	Mobile Self-Dumping Hopper	83½" l x 46" w x 57½" h	2 cu yd	1,000 lb	353 lb	213 cm x 116.8 cm x 146.4 cm	1.5 m <sup>3</sup>	453.6 kg	160.1 kg	BLA	1	3,598.00

### 2½ CUBIC YARD TILT TRUCKS

No.	Description	U.S. Dimensions	U.S. Size	U.S. Capacity	U.S. Ship Wt/Ctn	Metric Dimensions	Metric Size	Metric Capacity	Metric Ship Wt/Ctn	Color	Pack	**U.S. List Price
1074 <sup>a</sup>	Self-Dumping Hopper	83½" l x 55" w x 49½" h	2½ cu yd	1,000 lb	304.5 lb	212.1 cm x 139.7 cm x 125.7 cm	1.9 m <sup>3</sup>	453.6 kg	138.1 kg	BLA	1	3,292.00
1074-43 <sup>a</sup>	Mobile Self-Dumping Hopper	83½" l x 55" w x 56½" h	2½ cu yd	1,000 lb	376 lb	212.1 cm x 139.7 cm x 143.8 cm	1.9 m <sup>3</sup>	453.6 kg	170.5 kg	BLA	1	3,840.00

### SELF-DUMPING HOPPER LID

No.	Description	U.S. Dimensions	U.S. Size	U.S. Capacity	U.S. Ship Wt/Ctn	Metric Dimensions	Metric Size	Metric Capacity	Metric Ship Wt/Ctn	Color	Pack	**U.S. List Price
1027	Lid for 1064 Self-Dumping Hopper	82½" l x 44½" w x 3" h			32.8 lb	210.5 cm x 113 cm x 7.6 cm			14.9 kg	BLA	1	480.00

<sup>a</sup> Custom colors available; contact Rubbermaid Customer Service at (800) 347-9800 for details.

<sup>a</sup> Requires 3 weeks lead time and are non-returnable.

## Cube Trucks

A complete line of trucks for waste collection, material transport, and laundry handling.

- Durability of Rotational Molding technology
- Diamond caster pattern provides superior maneuverability
- Towable trainable model offers corner casters
- Standard Duty models designed to supports USDA Meat & Poultry Equipment Compliance
- Assists in complying with HACCP guidelines
- Spring platform option elevates contents to a convenient working height
- Heavy Duty Utility models include metal body support band
- Optional hinged domed lid available.



4612 / 4613



4727



4727-41

### 8 CUBIC FOOT (6.5 BUSHEL)

No.	Description	U.S. Dimensions	U.S. Bushel (BU)	U.S. Size	U.S. Capacity	U.S. Ship Wt/Ctn	Metric Dimensions	Metric Size	Metric Capacity	Metric Ship Wt/Ctn	Color	Pack	**U.S. List Price
4608	Cube Truck	38" l x 26" w x 28 1/2" h	6.5	8 cu ft	300 lb	36 lb	96.5 cm x 66 cm x 71.4 cm	.2 m <sup>3</sup>	136.1 kg	16.3 kg	DBLUE, BLA, WHT	1	338.00
4708	Utility Truck, Heavy-Duty with 4" dia (10.2 cm) Casters	38 3/4" l x 26" w x 28 3/4" h	6.5	8 cu ft	700 lb	48 lb	97.5 cm x 66 cm x 71.8 cm	.2 m <sup>3</sup>	317.5 kg	21.8 kg	BLA	1	476.00

### 12 CUBIC FOOT (10 BUSHEL)

No.	Description	U.S. Dimensions	U.S. Bushel (BU)	U.S. Size	U.S. Capacity	U.S. Ship Wt/Ctn	Metric Dimensions	Metric Size	Metric Capacity	Metric Ship Wt/Ctn	Color	Pack	**U.S. List Price
4612	Cube Truck	42 3/4" l x 28" w x 33" h	10	12 cu ft	400 lb	40 lb	108.6 cm x 71.1 cm x 83.8 cm	.3 m <sup>3</sup>	181.4 kg	18.1 kg	DBLUE, BLA, WHT	1	444.00
4712	Utility Truck, Heavy-Duty with 4" dia (10.2 cm) Casters	43 3/4" l x 28" w x 33 3/4" h	10	12 cu ft	800 lb	62.3 lb	109.9 cm x 71.1 cm x 86 cm	.3 m <sup>3</sup>	362.9 kg	28.3 kg	BLA	1	582.00

### 14 CUBIC FOOT (13.2 BUSHEL)

No.	Description	U.S. Dimensions	U.S. Bushel (BU)	U.S. Size	U.S. Capacity	U.S. Ship Wt/Ctn	Metric Dimensions	Metric Size	Metric Capacity	Metric Ship Wt/Ctn	Color	Pack	**U.S. List Price
4611	Spring Platform Truck	44 1/4" l x 31" w x 32 1/2" h	13.2	14 cu ft	500 lb	60 lb	112.1 cm x 78.7 cm x 82.6 cm	.4 m <sup>3</sup>	226.8 kg	27.2 kg	BLA	1	660.00
4614	Cube Truck	44 1/4" l x 31" w x 32 1/2" h	15.2	14 cu ft	500 lb	47 lb	112.1 cm x 78.7 cm x 82.6 cm	.4 m <sup>3</sup>	226.8 kg	21.3 kg	BLA, WHT	1	490.00

### 16 CUBIC FOOT (13 BUSHEL)

No.	Description	U.S. Dimensions	U.S. Bushel (BU)	U.S. Size	U.S. Capacity	U.S. Ship Wt/Ctn	Metric Dimensions	Metric Size	Metric Capacity	Metric Ship Wt/Ctn	Color	Pack	**U.S. List Price
4616	Cube Truck	43 3/4" l x 31" w x 37" h	13	16 cu ft	500 lb	51 lb	111.1 cm x 78.7 cm x 94 cm	.5 m <sup>3</sup>	226.8 kg	23.1 kg	DBLUE, BLA, WHT	1	538.00
4616-06	Cube Truck with the Universal Recycle Symbol	43 3/4" l x 31" w x 37" h	13	16 cu ft	500 lb	51 lb	111.1 cm x 78.7 cm x 94 cm	.5 m <sup>3</sup>	226.8 kg	23.1 kg	BLUE	1	538.00
4716	Utility Truck, Heavy-Duty with 5" dia (12.7 cm) Casters	44 3/4" l x 31" w x 38 3/4" h	13	16 cu ft	1,000 lb	74.3 lb	112.7 cm x 78.7 cm x 97.2 cm	.5 m <sup>3</sup>	453.6 kg	33.7 kg	BLA	1	696.00

### 20 CUBIC FOOT (16 BUSHEL)

No.	Description	U.S. Dimensions	U.S. Bushel (BU)	U.S. Size	U.S. Capacity	U.S. Ship Wt/Ctn	Metric Dimensions	Metric Size	Metric Capacity	Metric Ship Wt/Ctn	Color	Pack	**U.S. List Price
4619	Cube Truck	48" l x 34 1/2" w x 36 1/2" h	16	20 cu ft	600 lb	60 lb	121.9 cm x 86.7 cm x 92.7 cm	.6 m <sup>3</sup>	272.2 kg	27.2 kg	BLA	1	632.00
4618	Spring Platform Truck	48" l x 34 1/2" w x 36 1/2" h	16	20 cu ft	600 lb	75 lb	121.9 cm x 86.7 cm x 92.7 cm	.6 m <sup>3</sup>	272.2 kg	34 kg	BLA	1	780.00
4720	Utility Truck, Heavy-Duty with 5" dia (12.7 cm) Casters	48 1/4" l x 34 1/2" w x 37 3/4" h	16	20 cu ft	1,200 lb	84.8 lb	122.6 cm x 86.7 cm x 96.2 cm	.6 m <sup>3</sup>	544.3 kg	38.5 kg	BLA	1	818.00

### 27 CUBIC FOOT (21.5 BUSHEL)

No.	Description	U.S. Dimensions	U.S. Bushel (BU)	U.S. Size	U.S. Capacity	U.S. Ship Wt/Ctn	Metric Dimensions	Metric Size	Metric Capacity	Metric Ship Wt/Ctn	Color	Pack	**U.S. List Price
4727	Utility Truck, Heavy-Duty with 5" dia (12.7 cm) Corner Casters	59" l x 34" w x 42 3/4" h	21.5	27 cu ft	1,200 lb	105 lb	149.9 cm x 84.1 cm x 109.2 cm	.8 m <sup>3</sup>	544.3 kg	47.6 kg	BLA	1	962.00
4727-41*	Towable Utility Truck, Heavy-Duty	59" l x 34" w x 42 3/4" h	21.5	27 cu ft	1,200 lb	120 lb	149.9 cm x 86.3 cm x 108.9 cm	.8 m <sup>3</sup>	544.3 kg	54.4 kg	BLA	1	1,404.00

\* Requires 2 weeks lead time and are non-returnable.

### SPRING KIT FOR PLATFORM TRUCKS

No.	Description	U.S. Dimensions	U.S. Ship Wt/Ctn	Metric Ship Wt/Ctn	Color	Pack	**U.S. List Price
4610	Spring Kit for 4611 Truck	34.2" l x 21.2" w x 1/2" h	12 lb	5.4 kg	0000	1	267.00
4625	Spring Kit for 4618 Truck	37.7" l x 24" w x 1/2" h	15 lb	68 kg	0000	1	282.00

## Color

See Product Description for Color Availability

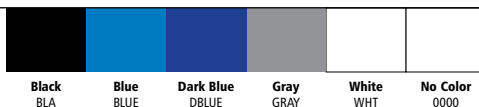

## Lids for Cube Trucks & Heavy-Duty Utility Trucks

No.	Description	U.S. Dimensions	U.S. Ship Wt/Ctn	Metric Dimensions	Metric Ship Wt/Ctn	Color	Pack	**U.S. List Price
4609 <sup>A</sup>	Lid for 4608 and 4708	38 <sup>3/4</sup> " l x 25 <sup>1/2</sup> " w x 8 <sup>1/2</sup> " h	13.5 lb	97.5 cm x 65.4 cm x 21.6 cm	6.1 kg	BLA	1	170.00
4613 <sup>A</sup>	Lid for 4612 and 4712	43 <sup>3/4</sup> " l x 27 <sup>1/2</sup> " w x 8 <sup>1/2</sup> " h	15.12 lb	109.5 cm x 69.8 cm x 21.6 cm	6.9 kg	BLA	1	185.00
4615 <sup>A</sup>	Lid for 4614, 4616, and 4716	44 <sup>1/4</sup> " l x 31" w x 8 <sup>1/2</sup> " h	17.15 lb	112.1 cm x 78.7 cm x 21.6 cm	7.8 kg	BLA	1	200.00
4617 <sup>A</sup>	Lid for 4619 and 4720	48 <sup>3/4</sup> " l x 34" w x 8 <sup>1/2</sup> " h	18.83 lb	123.2 cm x 86.4 cm x 21.6 cm	8.5 kg	BLA	1	215.00
4726	Lid for 4727, 4727-41 Heavy-Duty Utility Truck	59 <sup>3/4</sup> " l x 34 <sup>3/4</sup> " w x 5" h	19.9 lb	151.1 cm x 87.6 cm x 13.7 cm	9 kg	BLA	1	290.00

<sup>A</sup> Custom colors available; contact Customer Service at (800) 347-9800 for details.

## BRUTE® Totes

The ultimate storage and transport container.

- Reinforced ribbed bottom protects container during dragging
- User-friendly grip handles decrease potential for back injury and finger strain
- Lid snaps tight, keeping contents secure



9530 / 9531



No.	Description	U.S. Dimensions	U.S. Capacity	U.S. Ship Wt/Ctn	Metric Dimensions	Metric Capacity	Metric Ship Wt/Ctn	Color	Pack	**U.S. List Price
9530	BRUTE® Tote with Lid	27 <sup>7/8</sup> " l x 17 <sup>7/8</sup> " w x 10 <sup>1/16</sup> " h	14 gal	46 lb	70.7 cm x 44.1 cm x 27.1 cm	53 L	20.8 kg	GRAY, WHT	6	25.60
9531	BRUTE® Tote with Lid	27 <sup>7/8</sup> " l x 17 <sup>7/8</sup> " w x 15 <sup>1/2</sup> " h	20 gal	53 lb	70.7 cm x 44.1 cm x 38.4 cm	75.7 L	24 kg	GRAY, WHT	6	31.20

## Stack & Nest Palletote® Boxes

For cost-effective storage and transportation.

- Fits 40" and 48" pallets with no overhang
- Nestable for efficient storage and transport; stackable with and without lids
- All plastic construction won't rust, dent, chip, or peel
- Rounded corners and smooth surfaces are easy to clean
- USDA 3A (Dairy) Sanitary Standards and Meat & Poultry Equipment Group Listed
- Slip resistant, extended bottom
- Materials are FDA compliant for food contact and certified to NSF Std. #2



1732



No.	Description	U.S. Dimensions	U.S. Capacity	U.S. Ship Wt/Ctn	Metric Dimensions	Metric Capacity	Metric Ship Wt/Ctn	Color	Pack	**U.S. List Price
1721	Palletote® Box	19 <sup>1/2</sup> " l x 15 <sup>1/2</sup> " w x 10" h	1.3 cu ft	42.58 lb	49.5 cm x 39.4 cm x 25.4 cm	.04 m <sup>3</sup>	19.3 kg	GRAY	10	34.20
1722	Palletote® Box	19 <sup>1/2</sup> " l x 15 <sup>1/2</sup> " w x 13" h	1.6 cu ft	57.87 lb	49.5 cm x 39.4 cm x 33 cm	.05 m <sup>3</sup>	26.2 kg	GRAY	10	42.00
1731	Palletote® Box	23 <sup>3/4</sup> " l x 19 <sup>1/2</sup> " w x 10" h	2 cu ft	60.568 lb	59.7 cm x 49.5 cm x 25.4 cm	.06 m <sup>3</sup>	27.5 kg	GRAY	10	45.00
1732	Palletote® Box	23 <sup>3/4</sup> " l x 19 <sup>1/2</sup> " w x 13" h	2.6 cu ft	92.19 lb	59.7 cm x 49.5 cm x 33 cm	.07 m <sup>3</sup>	41.8 kg	GRAY	10	55.40

## LIDS

No.	Description	U.S. Dimensions	U.S. Ship Wt/Ctn	Metric Dimensions	Metric Ship Wt/Ctn	Color	Pack	**U.S. List Price
1720	Palletote® Lid for 1721, 1722	19 <sup>1/2</sup> " l x 15 <sup>1/2</sup> " w x 1" h	16.1 lb	49.8 cm x 39.7 cm x 2.5 cm	7.3 kg	GRAY	10	15.80
1730	Palletote® Lid for 1731, 1732	23 <sup>3/4</sup> " l x 19 <sup>1/2</sup> " w x 1" h	22.126 lb	60.3 cm x 50.2 cm x 2.5 cm	10 kg	GRAY	10	17.80

## ActionPacker® Storage Containers

Organized tool storage and transportation for industry professionals.

- Durable, weather-resistant construction
- Tough, lockable latches keep contents secure
- Stackable containers are easily tied down with bungee cords



1172



1192



1192

No.	Description	U.S. Dimensions	U.S. Capacity	U.S. Ship Wt/Ctn	Metric Dimensions	Metric Capacity	Metric Ship Wt/Ctn	Color	Pack	**U.S. List Price
1172	ActionPacker® Storage Container	26 <sup>1</sup> / <sub>8</sub> " l x 16 <sup>5</sup> / <sub>8</sub> " w x 18 <sup>1</sup> / <sub>2</sub> " d	24 gal	46 lb	66.2 cm x 43 cm x 47.1 cm	90.8 L	20.9 kg	BLA	4	58.20
1191	ActionPacker® Cargo Box	34 <sup>1</sup> / <sub>2</sub> " l x 16 <sup>5</sup> / <sub>8</sub> " w x 18 <sup>1</sup> / <sub>2</sub> " d	35 gal	24 lb	87.6 cm x 41.6 cm x 47 cm	132.5 L	10.9 kg	BLA	1	102.00
1192	ActionPacker® Cargo Box	43 <sup>3</sup> / <sub>4</sub> " l x 17 <sup>1</sup> / <sub>2</sub> " w x 20 <sup>1</sup> / <sub>2</sub> " d	48 gal	29 lb	111.1 cm x 43.6 cm x 52.1 cm	181.6 L	13.1 kg	BLA	1	125.50

## Tool Boxes

Professional-grade tool boxes for commercial/industrial use.

- Made of sturdy structural foam construction that won't rust, dent, chip, or peel
- Removable trays provide added compartmentalized storage area
- Metal latches can be padlocked for security



7802



7804



No.	Description	U.S. Dimensions	U.S. Ship Wt/Ctn	Metric Dimensions	Metric Ship Wt/Ctn	Color	Pack	**U.S. List Price
7802	Tool Box	26" l x 11 <sup>1</sup> / <sub>2</sub> " w x 11 <sup>1</sup> / <sub>2</sub> " h	21.7 lb	66 cm x 29.2 cm x 28.3 cm	9.8 kg	BLA	2	81.00
7804	Tool Box	36" l x 18 <sup>1</sup> / <sub>2</sub> " w x 20 <sup>1</sup> / <sub>2</sub> " h	33 lb	91.4 cm x 46.9 cm x 51.1 cm	15 kg	BLA	1	180.00
7721	Caster Kit, 3" Dia., Fits 7804		3.8 lb		1.7 kg	0000	1	49.60

## Color

See Product Description for Color Availability



Black  
BLA

Gray  
WHT

No Color  
0000



## Structural Foam Stock Tanks

Built tough for superior performance and long-lasting durability in all kinds of weather.

- Five sizes to fit all your watering needs, from 50 to 300 gallons
- Seamless construction for outstanding durability
- Oversize 1½" drain plug for easy draining and cleaning
- All-plastic anti-siphon float valve provides constant water level

### FLOAT VALVE

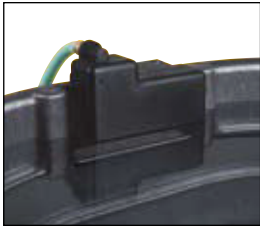

4248-06 fits all Rubbermaid Stock Tanks



No.	Description	U.S. Dimensions	U.S. Capacity	U.S. Ship Wt/Ctn	Metric Dimensions	Metric Capacity	Metric Ship Wt/Ctn	Color	Pack	** U.S. List Price
4242	100 Gal. Stock Tank	52" l x 31" w x 25" h	100 gal	41 lb	132 cm x 78.7 cm x 63.5 cm	378.5 L	18.59 kg	BLA	1	118.00
4243	50 Gal. Stock Tank	52" l x 31" w x 12" h	50 gal	23.5 lb	132 cm x 78.7 cm x 30.4 cm	189.2 L	10.7 kg	BLA	1	104.50
4244	70 Gal. Stock Tank	40½" l x 32" w x 24" h	70 gal	24.8 lb	102.8 cm x 81.2 cm x 60.9 cm	265 L	11.25 kg	BLA	1	112.50
4245	150 Gal. Stock Tank	58" l x 39" w x 25" h	150 gal	53.0 lb	147.3 cm x 99.0 cm x 63.5 cm	567.8 L	24.1 kg	BLA	1	197.50
4247	300 Gal. Stock Tank	63¼" l x 69" w x 25" h	300 gal	83.0 lb	160.7 cm x 175.2 cm x 63.5 cm	1135.5 L	37.7 kg	BLA	1	312.00
4248-06	Stock Tank Float Valve	9" l x 5" w x 6¼" h		12.0 lb	22.8 cm x 12.7 cm x 16 cm		5.44 kg	BLA	6	24.20
5050-12	Stock Tank Drain Plug Kit			2.5 lb			1.1 kg	-	12	20.40

## Structural Foam Tack Box with Padded Top

All purpose storage at the work site, in the stable, or on the water.

- Padded 2" cushion for comfortable seating
- Heavy-duty structural foam construction
- Two interior trays provide storage for small items
- Caster kit available (#7721)
- Lockable for added security
- Molded-in side handles make lifting and transporting of heavy loads easier



No.	Description	U.S. Dimensions	U.S. Ship Wt/Ctn	Metric Dimensions	Metric Ship Wt/Ctn	Color	Pack	** U.S. List Price
7720	Structural Foam Tack Box	36" l x 24" w x 24" h	36.2 lb	91.5 cm x 61 cm x 61 cm	16.42 kg	BLA	1	207.00
7721	Caster Kit, 3" Dia., Fits 7720		3.80 lb		1.72 kg	-	1	49.60