

ACCESSORIES CATALOGUE 2018/19



Milwaukee[®]

Nothing but **HEAVY DUTY.**[™]

Contents		Page No.	
Abrasives	- Coated - Abrasive Paper	115-117	
	- Cutting and Grinding Discs	109-110	
	- Flap Discs	111	
Angle Grinder System Accessories / FIXTEC Nut		112-114	
Bandsaw Blades		148	
Batteries & Chargers		165/167	
Biscuit Jointer System Accessories		156	
Cable Cutter/Pipe Cutter System Accessories		154-155/157	
Caulk and Adhesive Gun System Accessories		162	
Chisels & Special Application Tools	- SDS-Plus	23-26	
	- SDS-Max	27-29 / 34	
	- 21 mm K-Hex	32-34	
	- 28 mm K-Hex	30-31	
Chucks	- Keyed & Keyless	91-92	
	- Chuck Adaptors	90	
Circular Saw Blades/System Accessories		145-147	
Cores/Tunnel Bits - TCT	- SDS-Plus	12	
	- SDS-Max	18-19	
	- SDS-Max Vario Extension System	20	
Crimping dies		151-153	
Diamond Blades/Diamond Cup Wheels		101-108	
Diamond Core Bits	- Wet Core Bits/System Accessories	93-95	
	- Dry Core Bits/System Accessories	96-100	
Drain Cleaner System Accessories		161	
Drill Bits ■ Concrete	- SDS-Plus M2	7-10	
	- SDS-Plus MX4	4-6	
	- SDS-Plus Contractor & Multipurpose	11	
	- SDS-Plus Dustless	11	
	- SDS-Max	15-16	
	- SDS-Max Dustless	17	
	<hr/>		
	■ Concrete/Masonry (round shank)	- Concrete	36
		- Concrete Super	37
	<hr/>		
■ Multi Material	- Multi Material	38	
<hr/>			
■ Wood	- Auger	41	
	- Auger Impact Rated	39	
	- Cable	47	
	- Flat Boring	46	
	- Forstner	42	
	- Lip & Spur	45	
<hr/>			
■ Selffeed Bits	- Switchblade™ Selffeed	43	
	- Selffeed	44	
	- Speed Feed™	47	
<hr/>			
■ Glass & Tile	- Glass & Tile	38	
<hr/>			
■ Metal	- HSS Annular Cutters	66	
	- HSS-Ground DIN 1897/Double Ended/DIN 340	59-60	
	- HSS-Ground <i>THUNDERWEB</i>	54-57	
	- HSS-Rollforged	52-53	
	- RED COBALT - HSS-Ground - DIN 338	61-62	
	- RED HEX - Shockwave HSS-Ground Titanium	58	
	- Step Drills	63-64	
	-		
Drill Connect		21-22	
Drilling System Accessories	- QUIK-LOK Cables/Side Handles/Right Angle Drill	160	
Dust Absorption System Accessories		163-164	
Expander Heads		155	
Grease		22	

Contents		Page No.
HACKZALL Blades		136
Heated Jacket System Accessories		159
Hand Tools	– Copper Tubing Cutters	195–196
	– Folding Rules	171–172
	– Hook & Pick Set	198
	– INKZALL™ Markers	178–179
	– Jobsite Scissors	183
	– Levels	173–177
	– Knives/Blades	180–183
	– Metal Snips	184
	– Plastic / PEX Cutter	185
	– Pliers	186–191
	– Ratchets	199
	– Saws	194
	– Screwdrivers / Nut Drivers	196–198
	– Staplers	199
	– Tape Measures	169–172
	– Wrenches	191–193
<hr/>		
■ Workgear and Storage	– Heavy Duty Accessory Sets	206
	– Heavy Duty Boxes / Inserts	207–208
	– Gloves	200
	– PACKOUT™	204–205
	– Softside	201–203
	– Transport cases	207
Holesaws	– Adjustable Hole Cutter	74
	– BIG HAWG™	48
	– Bi-Metal <i>Hole Dozer</i> ™	68–73
	– Diamond Plus™	75
	– <i>Hole Dozer</i> ™ with Carbide teeth	73
	– Universal TCT	13–14
	– Shockwave Impact Holesaws	76
Impact Wrench System Accessories		89
Inspection Camera System Accessories		159
Jigsaw Blades / System Accessories		137–143
Lamps and Bulbs		165–166
Line trimmer System Accessories		160
Knockout Punch System Accessories		154
Magnetic Drill Stand / System Accessories		67
Nails & Staples		158
Nibbler System Accessories		157
Multitool Accessories		144
Planer Accessories		147
Plate Shear System Accessories		156
Polishing Accessories		120–121
Press Jaws		149–150
Router System Accessories		155
Sanding System Accessories		118–119
SAWZALL® Blades / System Accessories		122–135
Screwdriving System Accessories		89
Screwdriving	– Standard Bits / Sets	77–78
	– Shockwave Bits / Sets	79–84
	– Shockwave Locking Bit Holders	86
	– Shockwave Magnetic Nut Drivers	88
	– Shockwave Magnetic Bit Holder / Adaptors	86–87
	– Offset Attachment Knuckle™	87
	– Offset Attachment OSD 2	88
	– Shockwave Sockets	84–85
Stiletto® Titanium Tools		209–210
Straight Die Grinder System Accessories		156
Test & Measurement System Accessories		157



OPTIMISED FOR SPEED ACCURACY & DURABILITY!



**HYBRID CARBIDE 90° 4 TIP
GEOMETRY (Ø 5-10 MM)**
OPTIMISED PERFORMANCE



4 BREAKER POINTS
PULVERIZE MATERIAL MORE
EFFICIENTLY



REBAR GUARDS
PREVENTS DRILL BIT LOCK
UP / JAMMING



**VARIABLE FLUTE
GEOMETRY**
FOR FASTER DRILLING

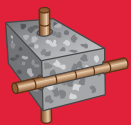

**4x
LIFE***



+20%**



The PGM seal guarantees
precisely fitting anchor
application holes over the
entire lifetime of the drill bit.

*vs. 2 cutter drill bit in reinforced concrete

**vs. 4 cutter drill bit in concrete and vs. previous generation



SDS-Plus MX4 drill bits - 4 cut

Symmetrical 4 cutter geometry (4x90°) Perfect round holes for optimal anchor fitting.
 4 flute geometry. The high volume 4 flute geometry ensures the optimum removal of dust and debris.
 Centering tip for easy spot drilling with pinpoint accuracy.
 Welded solid carbide tip on Ø 5-10 mm. Allows for wider flute entrance leading to increased speed. More carbide leads to a higher durability of the tip and higher lifetime. 4 breaker points pulverize material more efficiently for faster drilling. Enhanced rebar guards for an improved resistance when hitting rebar.
 New variable flute design. Thin flute at the tip for maximum debris extraction, higher speed and less friction.
 Thick flute at the base for higher stability and reduced bit breakage. Up to 20% more holes per battery charge vs 4 cutter drill bit in concrete and vs. previous generation.
 Made in Germany.

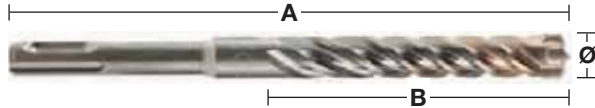
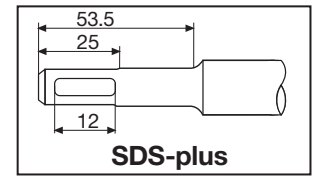

Diameter (mm)	Total length (mm) A	Working length (mm) B	Pre-drill	Pack quantity	Min. order quantity	Article Number	EAN Code
5	115	50		1	1	4932352007	4002395366644
5	165	100		1	1	4932352008	4002395368891
5.5	115	50		1	1	4932352009	4002395368907
5.5	165	100		1	1	4932352010	4002395368914
6	115	50		1	1	4932352011	4002395368921
6	165	100		1	1	4932352012	4002395368938
6	215	150		1	1	4932352013	4002395366705
6	265	200		1	1	4932352014	4002395366712
6	315	250		1	1	4932352015	4002395366729
6.5	165	100		1	1	4932430146	4002395378074
6.5	215	150		1	1	4932352016	4002395366736
6.5	265	200		1	1	4932352017	4002395366743
6.5	315	250		1	1	4932352018	4002395366750
7	115	50		1	1	4932352019	4002395366767
7	165	100		1	1	4932352020	4002395366774
8	115	50		1	1	4932352021	4002395366781
8	165	100		1	1	4932352022	4002395366798
8	215	150		1	1	4932352023	4002395366804
8	265	200		1	1	4932352024	4002395366811
8	315	250		1	1	4932352712	4002395373703
8	455	400	✓	1	1	4932352713	4002395373710
9	160	100		1	1	4932352944	4002395376025
10	110	50		1	1	4932352025	4002395366828
10	160	100		1	1	4932352026	4002395366835
10	210	150		1	1	4932352027	4002395366842
10	260	200		1	1	4932352028	4002395366859
10	310	250		1	1	4932352029	4002395366866
10	450	400	✓	1	1	4932352030	4002395366873
10	600	540	✓	1	1	4932352945	4002395376032
10	1000	940	✓	1	1	4932352946	4002395376049
12	160	100		1	1	4932352031	4002395366880
12	210	150		1	1	4932352032	4002395366897
12	260	200		1	1	4932352033	4002395366903
12	310	250		1	1	4932352034	4002395366910
12	450	400	✓	1	1	4932352035	4002395366927
12	600	540	✓	1	1	4932352947	4002395376056
12	1000	940	✓	1	1	4932352948	4002395376063
14	160	100		1	1	4932352036	4002395366934
14	210	150		1	1	4932352037	4002395366941
14	260	200		1	1	4932352949	4002395376070
14	310	250		1	1	4932352038	4002395366958
14	450	400	✓	1	1	4932352039	4002395366965
14	600	540	✓	1	1	4932352950	4002395376087
14	1000	940	✓	1	1	4932352951	4002395376094
15	160	100		1	1	4932430725	4002395383863
15	260	200		1	1	4932352952	4002395376100
16	160	100		1	1	4932430726	4002395383870
16	210	150		1	1	4932352953	4002395376117
16	260	200	✓	1	1	4932352819	4002395374779
16	310	250		1	1	4932352954	4002395376124
16	450	400	✓	1	1	4932352820	4002395374786

✓ Pre drill with a short drill bit of the same diameter.

SDS-Plus MX4 drill bits - 4 cut

✓ Pre drill with a short drill bit of the same diameter.

Diameter (mm)	Total length (mm) A	Working length (mm) B	Pre-drill	Pack quantity	Min. order quantity	Article Number	EAN Code
16	600	540	✓	1	1	4932352955	4002395376131
16	1000	940	✓	1	1	4932352956	4002395376148
18	250	200		1	1	4932356502	4002395320950
18	450	400	✓	1	1	4932356503	4002395320967
20	250	200		1	1	4932356504	4002395320974
20	450	400	✓	1	1	4932356505	4002395320981
22	250	200		1	1	4932399332	4002395359608
22	450	400	✓	1	1	4932356506	4002395320998
24	250	200		1	1	4932356507	4002395321001
24	450	400	✓	1	1	4932356508	4002395321018
25	250	200		1	1	4932399333	4002395359615
25	450	400	✓	1	1	4932356509	4002395321025
28	250	200		1	1	4932399334	4002395359622
28	450	400	✓	1	1	4932356510	4002395321032
30	250	200		1	1	4932399335	4002395359639
30	450	400	✓	1	1	4932356511	4002395321049
32	450	400	✓	1	1	4932399336	4002395359646

SDS-Plus MX4 drill bits - 4 cut / 10 pack

Diameter (mm)	Total length (mm) A	Working length (mm) B	Pack quantity	Min. order quantity	Article Number	EAN Code
5	115	50	10	1	4932352040	4002395366972
5.5	165	100	10	1	4932352041	4002395366989
6	115	50	10	1	4932352042	4002395366996
6	165	100	10	1	4932352043	4002395367009
6	215	150	10	1	4932430234	4002395378951
6.5	215	150	10	1	4932430235	4002395378968
6.5	265	200	10	1	4932459588	4058546027605
7	165	100	10	1	4932352044	4002395367016
8	115	50	10	1	4932352045	4002395367023
8	165	100	10	1	4932352046	4002395367030
10	160	100	10	1	4932352047	4002395367047
10	210	150	10	1	4932352048	4002395367054
12	160	100	10	1	4932352049	4002395367061
12	210	150	10	1	4932352050	4002395367078

SDS-Plus MX4 drill bits - 4 cut / 50 pack

Diameter (mm)	Total length (mm) A	Working length (mm) B	Pack quantity	Min. order quantity	Article Number	EAN Code
6	115	50	50	1	4932430437	4002395380985
6	165	100	50	1	4932430438	4002395380992
6	215	150	50	1	4932430462	4002395381234
6.5	215	150	50	1	4932430463	4002395381241
6.5	265	200	50	1	4932459589	4058546027612
8	165	100	50	1	4932430439	4002395381005
8	215	150	50	1	4932430440	4002395381012
10	160	100	50	1	4932430441	4002395381029
10	210	150	50	1	4932430442	4002395381036
12	210	150	50	1	4932430443	4002395381043

SDS-Plus MX4 - 4 cut / sets

Description	Supplied in	Pack quantity	Min. order quantity	Article Number	EAN Code
SDS-Plus drill bit set (5 pcs).					
① Ø 5 / 6 x 115 mm, Ø 6 / 8 x 165 mm, Ø 10 x 160 mm.	Plastic container	5	1	4932352833	4002395374915
SDS-Plus drill bit set (5 pcs).					
① Ø 5.5 x 115 mm, Ø 5.5 / 6 / 7 / 8 x 165 mm.	Plastic container	5	1	4932352835	4002395374939
SDS-Plus drill bit set (7 pcs).					
② Ø 5 / 6 / 8 x 115 mm, Ø 6 / 8 x 165 mm, Ø 10 / 12 x 160 mm.	Plastic cassette	7	1	4932451464	4002395162147
Counter display.					
③ 6 x 7 pc SDS-plus MX4 set 4932451464.	Plastic cassette	6	1	4932352153	4002395368068





FASTER THAN EVER



Breaker points

- 3 offset aggressive breaker points. These produce a “Demolition” effect and create micro cracks in the drilled material
- +25% FASTER*

Centering tip

- Ensures immediate spot drilling with pin point accuracy
- Prevents skidding on smooth surfaces



Enlarged rebar chamfers

- Enlarged rebar chamfers
- Prevents side tip damage when hitting rebar
- Reduces the risk of the drill bit jamming when hitting rebar



Tapered shoulder design

- Thinner shoulder towards drill tip for less friction providing for greater speed
- Ideal for cordless hammers identified from its tapered shoulder geometry



Reinforced flute

- High volume flute geometry for optimum dust removal
- Reinforced flute design (thicker core) gives:
 - Full power transfer to the tip
 - Lower vibrations
 - Exceptional break resistance, less breakages and best durability



+25% FASTER*

*vs. previous generation

SDS-Plus drill bits - 2 cut



FASTEST: New aggressive tip geometry with 3 chip breakers demolishes the concrete quicker and a tapered shoulder design minimises friction enabling the M2 drill bit to deliver faster drilling speed.
DURABILITY: Rebar chamfers on the tip prevent side tip damage when hitting metal reinforcement and a thicker core body ensures higher power transfer, lower vibrations and less flute breakages.

Made in Germany.

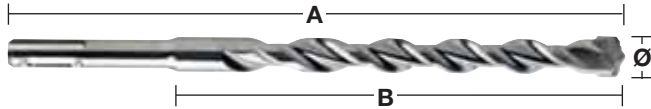
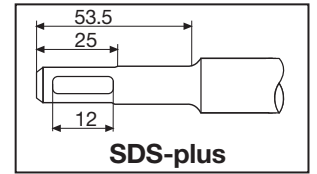

Diameter (mm)	Total length (mm) A	Working length (mm) B	Pre-drill	Pack quantity	Min. order quantity	Article Number	EAN Code
3	110	50		1	1	4932352892	4002395375509
3.5	110	50		1	1	4932373908	4002395353378
4	110	50		1	1	4932339498	4002395304561
4	160	100		1	1	4932399143	4002395357505
4.8	110	50		1	1	4932352130	4002395367832
5	110	50		1	1	4932307067	4002395308835
5	160	100		1	1	4932399315	4002395359431
5	210	150		1	1	4932399316	4002395359448
5.5	110	50		1	1	4932339499	4002395304578
5.5	160	100		1	1	4932340408	4002395311910
5.5	210	150		1	1	4932399317	4002395359455
5.5	260	200		1	1	4932399318	4002395359462
5.5	310	250		1	1	4932399319	4002395359479
5.5	410	350		1	1	4932399320	4002395359486
6	110	50		1	1	4932307068	4002395308842
6	160	100		1	1	4932307069	4002395308859
6	210	150		1	1	4932373136	4002395346394
6	260	200		1	1	4932353819	4002395320127
6	310	250		1	1	4932399321	4002395359493
6	460	400	✓	1	1	4932399322	4002395359509
6.5	110	50		1	1	4932344292	4002395312276
6.5	160	100		1	1	4932344293	4002395312269
6.5	210	150		1	1	4932399147	4002395357574
6.5	260	200		1	1	4932399148	4002395357581
6.5	310	260		1	1	4932399323	4002395359516
7	110	50		1	1	4932353820	4002395320134
7	160	100		1	1	4932340409	4002395311927
7	210	150		1	1	4932399222	4002395358366
7	250	200		1	1	4932399324	4002395359523
8	110	50		1	1	4932307070	4002395308866
8	160	100		1	1	4932307071	4002395308873
8	210	150		1	1	4932307072	4002395308880
8	260	200		1	1	4932353821	4002395320141
8	310	250		1	1	4932399325	4002395359530
8	400	350		1	1	4932399326	4002395359547
8	460	400	✓	1	1	4932367013	4002395336692
8	600	550	✓	1	1	4932399327	4002395359554
8	1000	950	✓	1	1	4932399328	4002395359561
9	160	100		1	1	4932353823	4002395320165
9	210	150		1	1	4932353822	4002395320158
10	110	50		1	1	4932340410	4002395311934
10	160	100		1	1	4932307073	4002395308897
10	210	150		1	1	4932307074	4002395308903
10	260	200		1	1	4932344295	4002395312252
10	310	250		1	1	4932353824	4002395320172
10	450	400	✓	1	1	4932344296	4002395312245
10	600	550	✓	1	1	4932367014	4002395336708
10	1000	950	✓	1	1	4932367015	4002395336715

SDS-Plus drill bits - 2 cut



Diameter (mm)	Total length (mm) A	Working length (mm) B	Pre-drill	Pack quantity	Min. order quantity	Article Number	EAN Code
11	160	100		1	1	4932367066	4002395336722
11	260	210		1	1	4932399329	4002395359578
12	160	110		1	1	4932307075	4002395308910
12	210	160		1	1	4932307076	4002395308927
12	260	210		1	1	4932344297	4002395312238
12	310	260		1	1	4932353825	4002395320189
12	450	400	✓	1	1	4932307077	4002395308934
12	600	550	✓	1	1	4932367068	4002395336746
12	1000	950	✓	1	1	4932367017	4002395336760
13	160	110		1	1	4932307946	4002395309054
13	260	210		1	1	4932344298	4002395312221
14	160	110		1	1	4932307078	4002395308941
14	210	160		1	1	4932353826	4002395320196
14	260	210		1	1	4932307079	4002395308958
14	310	260		1	1	4932399330	4002395359585
14	450	400	✓	1	1	4932307088	4002395309047
14	600	550	✓	1	1	4932367018	4002395336777
14	1000	950	✓	1	1	4932367019	4002395336784
15	160	110		1	1	4932373910	4002395353392
15	260	210		1	1	4932344300	4002395312207
16	160	110		1	1	4932307080	4002395308965
16	210	160		1	1	4932307081	4002395308972
16	260	210		1	1	4932399331	4002395359592
16	310	260		1	1	4932344301	4002395312191
16	450	400	✓	1	1	4932307082	4002395308989
16	600	550	✓	1	1	4932367069	4002395336791
16	1000	950	✓	1	1	4932367021	4002395336814
18	200	150		1	1	4932344303	4002395312177
18	250	200		1	1	4932307083	4002395308996
18	300	250		1	1	4932344304	4002395312160
18	450	400	✓	1	1	4932340411	4002395311941
18	600	550	✓	1	1	4932367022	4002395336821
18	1000	950	✓	1	1	4932367024	4002395336845
20	200	150		1	1	4932344305	4002395312153
20	250	200		1	1	4932307084	4002395309009
20	300	250		1	1	4932399027	4002395356126
20	450	400	✓	1	1	4932307085	4002395309016
20	600	550	✓	1	1	4932367025	4002395336876
20	1000	950	✓	1	1	4932367026	4002395336883
22	250	200		1	1	4932373911	4002395353408
22	450	400	✓	1	1	4932344307	4002395312139
22	600	550	✓	1	1	4932367027	4002395336890
22	1000	950	✓	1	1	4932367029	4002395336913
24	250	200		1	1	4932373922	4002395353521
24	450	400	✓	1	1	4932307087	4002395309030
25	250	200		1	1	4932344308	4002395312122
25	450	400	✓	1	1	4932344309	4002395312115
25	1000	950	✓	1	1	4932367030	4002395336975
26	250	200		1	1	4932344310	4002395323814
26	450	400	✓	1	1	4932344311	4002395312092

✓ Pre drill with a short drill bit of the same diameter.

SDS-plus drill bits - 2 cut/counter displays



Description	Pack quantity	Min. order quantity	Article Number	EAN Code
① Counter display. 10 x 7 pc SDS-Plus drill set 4932352339.	10	1	4932352341	4002395370009
② Counter display. 10 x 10 pc SDS-Plus drill set 4932352340.	10	1	4932352342	4002395370016



SDS-Plus drill bits - 2 cut / 10 pack

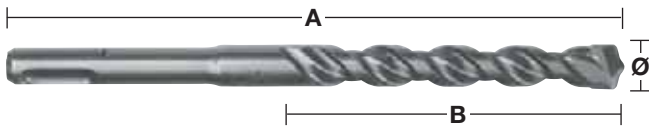

Diameter (mm)	Total length (mm) A	Working length (mm) B	Pack quantity	Min. order quantity	Article Number	EAN Code
5	110	50	10	1	4932371702	4002395344017
5	160	100	10	1	4932352520	4002395371785
5.5	110	50	10	1	4932352521	4002395371792
5.5	160	100	10	1	4932371703	4002395344024
6	110	50	10	1	4932371704	4002395344031
6	160	100	10	1	4932371705	4002395344048
6	210	150	10	1	4932399337	4002395359653
6.5	160	100	10	1	4932399338	4002395359660
6.5	210	150	10	1	4932399339	4002395359677
6.5	260	200	10	1	4932399340	4002395359684
7	160	100	10	1	4932373225	4002395348619
8	160	100	10	1	4932371706	4002395344055
8	210	150	10	1	4932399341	4002395359691
10	110	50	10	1	4932352522	4002395371808
10	160	100	10	1	4932371708	4002395344079
10	210	150	10	1	4932371709	4002395344086
10	260	200	10	1	4932399342	4002395359707
12	160	100	10	1	4932399343	4002395359714
12	210	160	10	1	4932371710	4002395344093
12	260	210	10	1	4932399344	4002395359721
14	260	210	10	1	4932371711	4002395344109

SDS-Plus drill bits - 2 cut / 50 pack



Diameter (mm)	Total length (mm) A	Working length (mm) B	Pack quantity	Min. order quantity	Article Number	EAN Code
5	110	50	50	1	4932399176	4002395357833
5.5	160	100	50	1	4932399177	4002395357840
6	110	50	50	1	4932399178	4002395357857
6	160	100	50	1	4932399179	4002395357864
7	160	110	50	1	4932399181	4002395357888
8	160	100	50	1	4932399182	4002395357895
8	210	150	50	1	4932399183	4002395357901
10	160	110	50	1	4932399345	4002395359738
10	210	150	50	1	4932399184	4002395357918
10	260	200	50	1	4932399185	4002395357925
12	210	160	50	1	4932399186	4002395357932

SDS-Plus drill bits - 2 cut / cassettes



Description	Pack quantity	Min. order quantity	Article Number	EAN Code
① Set of 5 SDS-Plus drill bits. Ø 5 / 6 x 110 mm and Ø 6 / 8 / 10 x 160 mm.	5	1	4932352338	4002395369973
① Set of 5 SDS-Plus drill bits. Ø 5.5 x 110 mm and Ø 5.5 / 6 / 7 / 8 x 160 mm.	5	1	4932352834	4002395374922
① Set of 5 SDS-Plus drill bits. Ø 10 / 12 / 14 / 16 / 20 x 450 mm.	5	1	4932352801	4002395374595
② Set of 7 SDS-Plus drill bits. Ø 5 / 6 / 8 x 110 mm and Ø 6 / 8 / 10 / 12 x 160 mm.	7	1	4932352339	4002395369980
③ Set of 10 SDS-Plus drill bits. Ø 5 / 6 / 6 x 110 mm and Ø 6 / 6 / 8 / 8 / 10 / 12 / 14 x 160 mm.	10	1	4932352340	4002395369997
Drill bit and chisel set (5 pcs) SDS-Plus drill bits Ø 6 / 8 / 10 x 160 mm, pointed and flat chisel.	5	1	4932430002	4002395376636



SDS-Plus contractor drill bits - 2 cut / 10 pack

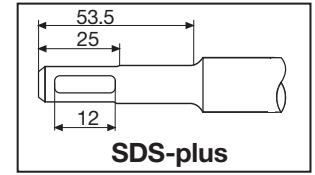
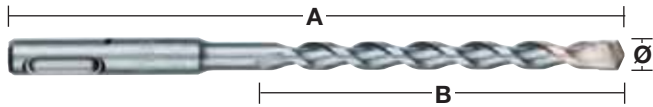

Diameter (mm)	Total length (mm) A	Working length (mm) B	Pack quantity	Min. order quantity	Article Number	EAN Code
5.5	160	100	10	1	4932352695	4002395373536
6	160	100	10	1	4932352696	4002395373543
7	160	100	10	1	4932352697	4002395373550
8	160	100	10	1	4932352698	4002395373567
8	210	150	10	1	4932352699	4002395373574
10	210	150	10	1	4932352700	4002395373581

SDS-Plus TCT multipurpose drill bits

These drill bits will drill in metal, wood and stone but in rotary mode only. Hammer action cannot be used with these drill bits. Ideal for tradesmen who need to drill through a variety of materials in one go. Made in Germany.

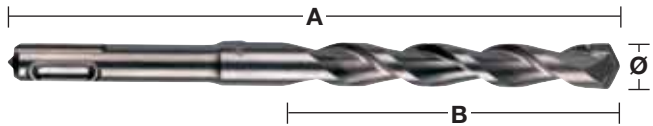

Diameter (mm)	Total length (mm) A	Working length (mm) B	Pack quantity	Min. order quantity	Article Number	EAN Code
6	160	100	1	1	4932373918	4002395353484
8	210	150	1	1	4932373919	4002395353491
10	260	200	1	1	4932373920	4002395353507
12	260	200	1	1	4932373921	4002395353514

SDS-Plus Dustless drill bits

Faster and more efficient drill bit due to effective dust removal. Efficient drilling without dust for a safer and cleaner working environment. Active drill bit head cooling for a longer life. 4 cutter design prevents the drill bit from jamming into the rebar. Accurate concentricity and high dimensional accuracy drilled holes, according to PGM Conformity. Universal connector for all common vacuum cleaners with hose diameter 32 – 38 mm.

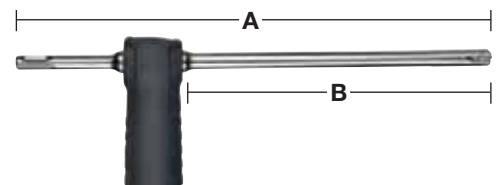

Diameter (mm)	Total length (mm) A	Working length (mm) B	Pack quantity	Min. order quantity	Article Number	EAN Code
12	325	200	1	1	4932459283	4058546002497
14	360	240	1	1	4932459284	4058546002503
16	360	240	1	1	4932459285	4058546002510
18	360	240	1	1	4932459286	4058546002527
Universal vacuum cleaner adaptor.			1	1	4931416173	4002395805501

SDS-Plus TCT core cutters

Core cutters for rotary hammers up to 4 kg.
 All TCT cores have a M16 x 2 thread and fit to both SDS-Plus and Hex 11 arbors.
 Arbor and pilot drill bit required additionally.
 Made in Germany.

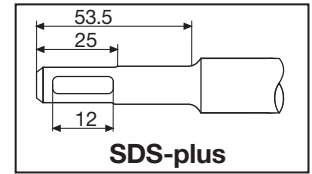

Diameter (mm)	Total length (mm) A	Pack quantity	Min. order quantity	Article Number	EAN Code
35	58	1	1	4932344478	4002395312559
50	58	1	1	4932344479	4002395312566
65	50	1	1	4932344480	4002395312573
68	50	1	1	4932399099	4002395357031
82	50	1	1	4932344481	4002395312580
90	50	1	1	4932344482	4002395312597

SDS-Plus TCT core cutter - set

Set version includes: TCT core cutter, SDS-Plus arbor 105 mm length, TCT pilot drill bit Ø 8 x 120 mm and allen key.

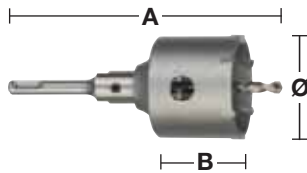

Diameter (mm)	Total length (mm) A	Working length (mm) B	Pack quantity	Min. order quantity	Article Number	EAN Code
65	182	50	4	1	4932399295	4002395359097
68	182	50	4	1	4932399296	4002395359103
82	182	50	4	1	4932399297	4002395359110

SDS-Plus TCT core cutter arbors

Both SDS-Plus and Hex arbors include an allen key and require a pilot drill bit additionally.



Description	Reception	Diameter (mm)	Total length (mm) A	Pack quantity	Min. order quantity	Article Number	EAN Code
① SDS-plus arbor.	SDS-Plus		105	2	1	4932399966	4002395366255
① SDS-plus arbor.	SDS-Plus		370	2	1	4932399967	4002395366262
② Hex arbor.	11 mm Hex		90	2	1	4932399968	4002395366279
③ TCT pilot drill bit for use in masonry, concrete, brick etc.		8	120	1	1	4932399125	4002395357291
③ TCT pilot drill bit with conical shaft for old style arbors. NOT SUITABLE for above arbors.		10	100	1	1	4932399020	4002395356058

TCT Universal Holesaws

TCT Universal Holesaws are ideal for electricians, carpenters, kitchen fitters and all related heating, ventilation and plumbing trades.

TCT Universal Holesaws are designed for use in a wide variety of materials such as:

- Bricks* – suitable for both solid bricks and bricks with cavities
- Aerated concrete blocks*, lightweight aggregate blocks and breeze blocks
- Soft density lime-sandstone building blocks upto hardness of 30 N/mm²
- Softwoods, chipboard, plywood, medium density fibreboard (MDF)
- Plastics and plastic coated board (Contiboard)
- Gypsum/plaster board

Application areas:

- Installation of electrical switch boxes and junction boxes.
- Fitting of spot and down lights.
- Through holes for cables, water and central heating pipes.
- Openings for ventilation and extractor pipework.

** Not suitable for use in hard materials such as concrete, granite, medium to hard density lime-sandstone block, natural stone and hard bricks over 30 N/mm² hardness.*

TCT Universal Holesaws can be used with pneumatic rotary hammers with SDS-plus reception and all rotary/percussion corded and cordless drills.

Important: the percussion/hammer action mode must be turned off when using these holesaws.



Features

① Robust and durable

Tungsten carbide teeth are dovetailed into the core body guaranteeing tougher material bonding and less tooth breakage.

② FIXTEC arbors

There are two types of arbor reception available, (1) standard Hex shaft for use with rotary/percussion drills or cordless tools and (2) SDS-plus reception for use with pneumatic rotary hammers.

Both arbors come with an innovative self locking FIXTEC mechanism for securing the pilot drill bit, eliminating the need for awkward grub screws. Spanner flats allow the core to be easily detached from the FIXTEC arbor.

③ Protection

TCT Universal Holesaws are only to be used without hammer action but in the event the hammer action is not deactivated when using the FIXTEC SDS-plus arbor, the holesaw will not be damaged.

The FIXTEC SDS-plus arbor has been especially designed with shorter than usual grooves so preventing the pneumatic hammer drill from hammering.

④ Material removal

Large dust chambers ensure effective and rapid material removal.

⑤ Core body

Lightweight thin wall design meets less resistance for faster cleaner drilling with less vibrations.

⑥ Pilot drill bit

This is available either in HSS for use in wood/plastics or carbide tipped for applications in masonry.

TCT Universal holesaws

All TCT Universal Holesaws have a M 16 thread and fit to both FIXTEC SDS-plus and Hex 11 reception arbors.

FIXTEC arbor and pilot drill required additionally.

Made in Germany.

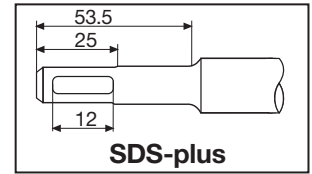

Diameter (mm)	Total length (mm) A	No. of teeth	Pack quantity	Min. order quantity	Article Number	EAN Code
25	60	3	1	1	4932399100	4002395357048
30	60	3	1	1	4932399101	4002395357055
35	60	3	1	1	4932399102	4002395357062
40	60	3	1	1	4932399103	4002395357079
45	60	3	1	1	4932399104	4002395357086
50	60	3	1	1	4932399105	4002395357093
55	60	3	1	1	4932399106	4002395357109
60	60	5	1	1	4932399108	4002395357123
63	60	5	1	1	4932399109	4002395357130
65	60	5	1	1	4932399110	4002395357147
68	60	5	1	1	4932399111	4002395357154
70	60	5	1	1	4932399112	4002395357161
74	60	5	1	1	4932399114	4002395357185
76	60	5	1	1	4932399115	4002395357192
80	60	5	1	1	4932399117	4002395357215
85	60	5	1	1	4932399118	4002395357222
90	60	5	1	1	4932399119	4002395357239
105	60	6	1	1	4932399120	4002395357246

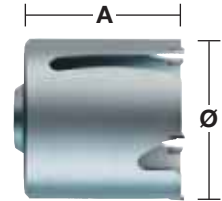

TCT Universal Holesaw set version

Set version includes: TCT universal holesaw, countersink, SDS-plus arbor 118 mm length and TCT pilot drill bit Ø 8 x 120 mm.

The countersink can be removed for use in wood and brick.

Diameter (mm)	Total length (mm) A	Working length (mm) B	Pack quantity	Min. order quantity	Article Number	EAN Code
68	205	60	4	1	4932399298	4002395359127

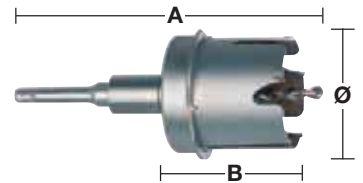

Countersink

Countersink - When fitted to the 68 mm holesaw it allows for the flush fitting of electrical switch boxes in drywall / plasterboard walls.

Diameter (mm)	Max. cutting depth (mm) A	No. of teeth	Pack quantity	Min. order quantity	Article Number	EAN Code
68	2	3	1	1	4932399127	4002395357314



TCT Universal Holesaw system attachments

Both SDS-plus and Hex arbors require a pilot drill bit additionally.

Description	Shank reception	Diameter (mm)	Total length (mm) A	Pack quantity	Min. order quantity	Article Number	EAN Code
① FIXTEC arbor.	SDS-Plus		118	1	1	4932399121	4002395357253
① FIXTEC arbor.	SDS-Plus		220	1	1	4932399134	4002395357406
① FIXTEC arbor.	SDS-Plus		370	1	1	4932399122	4002395357260
② FIXTEC arbor.	11 mm Hex		118	1	1	4932399123	4002395357277
② FIXTEC arbor.	11 mm Hex		370	1	1	4932399124	4002395357284
③ TCT pilot drill bit for use in masonry, concrete, brick etc.		8	120	1	1	4932399125	4002395357291
④ HSS pilot drill bit for use in wood and plastic.		7.4	120	1	1	4932399126	4002395357307

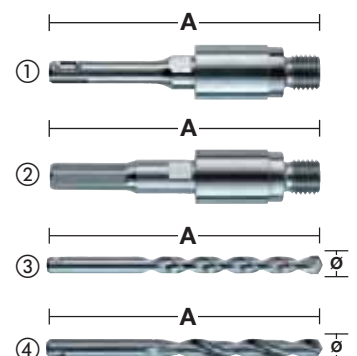

SDS-MAX DRILL BITS

FASTER DRILLING, LONGER LIFETIME

THE NEW GENERATION OF SDS-MAX CARBIDE DRILL BITS PROVIDE THE FASTEST AND MOST DURABLE SOLUTION FOR DRILLING INTO REINFORCED CONCRETE



VARIABLE FLUTE GEOMETRY
FOR FASTER DRILLING



REINFORCED FLUTE
LOWER VIBRATIONS AND LESS BREAKAGES



4 X 90° TIP GEOMETRY
DELIVERS BEST PERFORMANCE IN REINFORCED CONCRETE AND ENSURES ROUND HOLES



BREAKER POINTS
PULVERISE MATERIAL MORE EFFICIENTLY



CENTERING POINT
ENSURES OPTIMUM GUIDANCE DURING DRILLING



REBAR CHAMFERS
PREVENTS DRILL BIT LOCK-UP/JAMMING

UP TO
25%
FASTER
VS PREVIOUS
GENERATION

Faster drilling and round holes ensured even when hitting rebar in concrete

SDS-MAX



SDS-Max drill bits - 4 cut

NEW

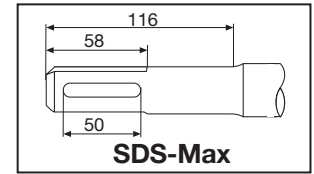
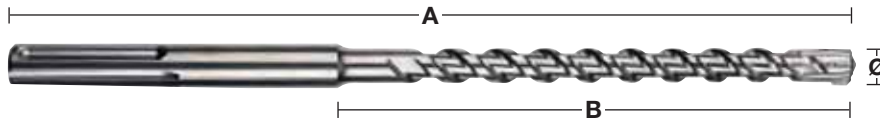

Diameter (mm)	Total length (mm) A	Working length (mm) B	Pre-drill	Pack quantity	Min. order quantity	Article Number	EAN Code
12	340	200		1	1	4932352750	4002395374083
12	540	400	✓	1	1	4932352751	4002395374090
12	690	550		1	1	4932430727	4002395383887
14	340	200		1	1	4932352752	4002395374106
14	540	400	✓	1	1	4932352753	4002395374113
15	340	200		1	1	4932352754	4002395374120
15	540	400	✓	1	1	4932352755	4002395374137
16	340	200		1	1	4932352756	4002395374144
16	540	400	✓	1	1	4932352757	4002395374151
16	940	800	✓	1	1	4932352758	4002395374168
16	1320	1180	✓	1	1	4932352759	4002395374175
18	340	200		1	1	4932352760	4002395374182
18	540	400	✓	1	1	4932352761	4002395374199
18	940	800	✓	1	1	4932352762	4002395374205
18	1320	1180	✓	1	1	4932352763	4002395374212
20	320	200		1	1	4932352764	4002395374229
20	520	400	✓	1	1	4932352765	4002395374236
20	920	800	✓	1	1	4932352766	4002395374243
20	1320	1200	✓	1	1	4932352767	4002395374250
22	320	200		1	1	4932352768	4002395374267
22	520	400	✓	1	1	4932352769	4002395374274
22	920	800	✓	1	1	4932352770	4002395374281
22	1320	1200	✓	1	1	4932352771	4002395374298
24	320	200		1	1	4932352772	4002395374304
24	520	400	✓	1	1	4932352773	4002395374311
25	320	200		1	1	4932352774	4002395374328
25	520	400	✓	1	1	4932352775	4002395374335
25	920	800	✓	1	1	4932352776	4002395374342
25	1320	1200	✓	1	1	4932352777	4002395374359
26	520	400		1	1	4932430728	4002395383894
28	370	250		1	1	4932352778	4002395374366
28	570	450	✓	1	1	4932352779	4002395374373
28	670	550	✓	1	1	4932352780	4002395374380
28	920	800	✓	1	1	4932352781	4002395374397
28	1320	1200	✓	1	1	4932352782	4002395374403
30	370	250		1	1	4932352783	4002395374410
30	570	450		1	1	4932352784	4002395374427
30	920	800		1	1	4932430729	4002395383900
32	370	250		1	1	4932352785	4002395374434
32	570	450		1	1	4932352786	4002395374441
32	920	800	✓	1	1	4932352787	4002395374458
32	1320	1200	✓	1	1	4932352788	4002395374465
35	370	250		1	1	4932352789	4002395374472
35	570	450		1	1	4932352790	4002395374489
35	920	800	✓	1	1	4932352791	4002395374496
38	370	250		1	1	4932352792	4002395374502
38	570	450		1	1	4932352793	4002395374519
40	370	250		1	1	4932352794	4002395374526
40	570	450	✓	1	1	4932352795	4002395374533
40	920	800	✓	1	1	4932352796	4002395374540
40	1320	1200	✓	1	1	4932352797	4002395374557
45	570	450		1	1	4932352798	4002395374564
45	920	800		1	1	4932430730	4002395383917
50	570	450		1	1	4932430731	4002395383924
52	570	450		1	1	4932352799	4002395374571
SDS-Max 5 pc drill bit set.							
Ø 16 / 18 x 540 mm, Ø 20 / 22 / 25 x 520 mm.				5	1	4932352800	4002395374588

SDS-Max Dustless drill bits

- Faster and more efficient drill bit due to effective dust removal.
- Efficient drilling without dust for a safer and cleaner working environment.
- Active drill bit head cooling for a longer life.
- 4 cutter design prevents the drill bit from jamming into the rebar.
- Accurate concentricity and high dimensional accuracy drilled holes, according to PGM Conformity.
- Universal connector for all common vacuum cleaners with hose diameter 32 – 38 mm.

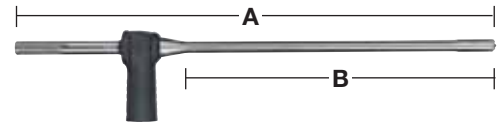

Diameter (mm)	Total length (mm) A	Working length (mm) B	Pack quantity	Min. order quantity	Article Number	EAN Code
16	600	400	1	1	4932459287	4058546002534
18	600	400	1	1	4932459288	4058546002541
20	600	400	1	1	4932459289	4058546002558
22	600	400	1	1	4932459290	4058546002565
24	600	400	1	1	4932459291	4058546002572
25	600	400	1	1	4932459292	4058546002589
28	600	400	1	1	4932459293	4058546002596
28	900	900	1	1	4932459294	4058546002602
30	600	400	1	1	4932459295	4058546002619
30	900	700	1	1	4932459296	4058546002626
32	600	400	1	1	4932459297	4058546002633
32	900	700	1	1	4932459298	4058546002640
35	600	400	1	1	4932459299	4058546002657
35	900	700	1	1	4932459300	4058546002664
Universal vacuum cleaner adaptor.			1	1	4931416173	4002395805501



SDS-Max TCT tunnel bits - One piece design

- One piece solid steel tool.
- Increased lifetime.
- Suitable for all rotary hammers.
- Made in Germany.
- Vario tunnel bits (supplied with thread)

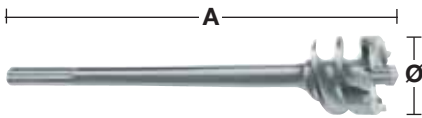
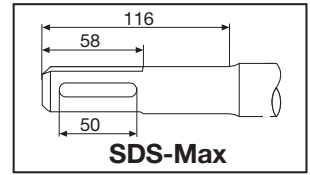

Diameter (mm)	Total length (mm) A	Pack quantity	Min. order quantity	Article Number	EAN Code
45	550	1	1	4932373892	4002395353217
45	990	1	1	4932399366	4002395359837
55	550	1	1	4932373893	4002395353224
55	990	1	1	4932399368	4002395359851
65	550	1	1	4932373894	4002395353231
65	990	1	1	4932399370	4002395359875
80	550	1	1	4932373895	4002395353248
80	990	1	1	4932399372	4002395359899

SDS-Max TCT core cutters - One piece design

- One piece solid steel tool.
- Increased lifetime.
- Supplied with pilot drill bit and ejector tool.
- Suitable for all rotary hammers.
- Made in Germany.

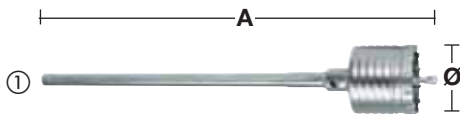

Description	Diameter (mm)	Total length (mm) A	Pack quantity	Min. order quantity	Article Number	EAN Code
①	50	290	1	1	4932399373	4002395359905
	50	550	1	1	4932373884	4002395353132
	68	290	1	1	4932399374	4002395359912
	68	550	1	1	4932373885	4002395353149
	80	290	1	1	4932399375	4002395359929
	80	550	1	1	4932373886	4002395353156
	100	550	1	1	4932373888	4002395353170
	125	550	1	1	4932373889	4002395353187
150	550	1	1	4932373890	4002395353194	
② Ejector tool.			1	1	4932399021	4002395356065
③ Pilot drill bit.	11	120	1	1	4932245967	4002395307111

SDS-Max TCT core cutters - Two piece design

Not suitable for rotary hammers > 10 kg.
Made in Germany.

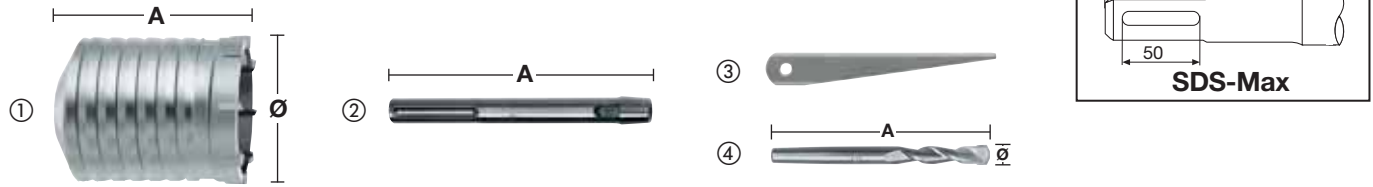

Description	Diameter (mm)	Total length (mm) A	Pack quantity	Min. order quantity	Article Number	EAN Code
①	40	100	1	1	4932245992	4002395307180
	50	100	1	1	4932430732	4002395383931
	60	100	1	1	4932430733	4002395383948
	65	100	1	1	4932245994	4002395307203
	68	100	1	1	4932430734	4002395383955
	80	100	1	1	4932245995	4002395307210
	90	100	1	1	4932430735	4002395383962
	100	100	1	1	4932367304	4002395336432
	125	100	1	1	4932367306	4002395336456
	150	100	1	1	4932367308	4002395336470
② Arbor SDS-Max.		180	1	1	4932343667	4002395315932
		450	1	1	4932343670	4002395315949
③ Ejector tool.			1	1	4932604214	4002395311231
④ Pilot drill bit.	11	120	1	1	4932245967	4002395307111

Adaptor



Description	Tool reception	Drill reception	Pack quantity	Min. order quantity	Article Number	EAN Code
Adaptor.	SDS-Max	SDS-Plus	1	1	4932359490	4002395325795

SDS-Max vario extension system

- Flexible tool system: can be extended to variable lengths in combination with core cutters or tunnel bits. We recommend a maximum of 3 extensions.
- Cost effective: different drill sizes can be exchanged easily and fast with the threaded stud system.
- Suitable for rotary hammers up to 8 kg.

Description	Diameter (mm)	Total length (mm) A	Pack quantity	Min. order quantity	Article Number	EAN Code
① SDS-Max arbor with internal thread.		195	1	1	4932430736	4002395383979
② Vario extension (incl. threaded stud)	25	280	1	1	4932430737	4002395383986
③ Vario threaded stud.			1	1	4932430738	4002395383993
④ Vario threaded stud with tapered end 1:8 for TCT core cutters.			1	1	4932430748	4002395384099
⑤ TCT core cutter.	40	100	1	1	4932245992	4002395307180
	50	100	1	1	4932430732	4002395383931
	60	100	1	1	4932430733	4002395383948
	65	100	1	1	4932245994	4002395307203
	68	100	1	1	4932430734	4002395383955
	80	100	1	1	4932245995	4002395307210
	90	100	1	1	4932430735	4002395383962
	100	100	1	1	4932367304	4002395336432
	125	100	1	1	4932367306	4002395336456
	150	100	1	1	4932367308	4002395336470
⑥ Ejector tool.			1	1	4932604214	4002395311231
⑦ Pilot drill bit.	11	120	1	1	4932245967	4002395307111
⑧ Vario tunnel bits (supplied with thread)	30	150	1	1	4932430739	4002395384006
	35	150	1	1	4932430740	4002395384013
	40	150	1	1	4932430743	4002395384044
	45	150	1	1	4932430744	4002395384051
	55	150	1	1	4932430745	4002395384068
	60	150	1	1	4932430741	4002395384020
	68	150	1	1	4932430746	4002395384075
	80	150	1	1	4932430747	4002395384082
	90	150	1	1	4932430742	4002395384037

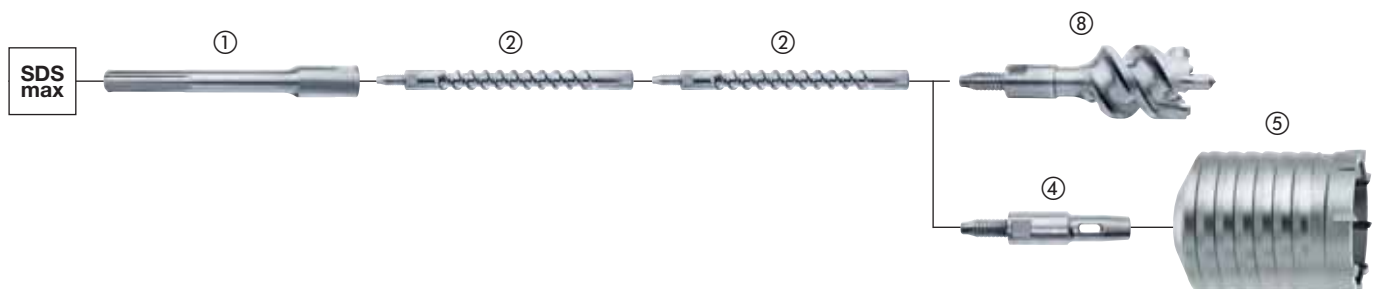
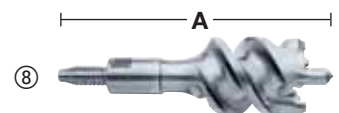
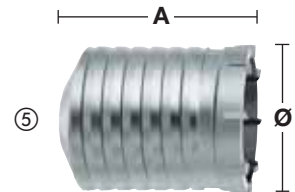
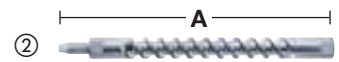

Drill Connect

The innovative and patented Drill Connect System is the ultimate solution for those requiring maximum versatility with large diameter drilling tools.

Versatile:

Drill Connect acts as a link between machine and drilling tools. On one side the system is totally compatible to all SDS-Max reception drilling tools such as drill bits, tunnel bits and core cutters. On the opposite side between the rotary hammer and the Drill Connect attachment one can fit the extension piece with the desired length.

Universal:

The extension pieces are offered in a range of lengths fitting to rotary hammers with either SDS-Max, Spline or 19 mm Hex reception. Short or long – the choice is yours!

Cost effective:

Professional users always require both long and short length drill bits and depending on the application sometimes even of the same diameter. But now, one can reduce the total number of drilling tools with the help of the Drill Connect System which makes it possible to interchange the drilling tools diameter and length in one simple step. Therefore users can reap the benefits of purchasing the cheaper short length drill bits and extending the length with the economical extensions plus the flexibility of Drill Connect reduces the overall quantity of drill bits one must carry in their toolbox.



100% Power:

The Drill Connect attachment provides a quick and safe connection between drilling tool and extension piece and therefore ensures that 100% of the power is completely transmitted to the drill bit tip.



Less weight:

The combination of short drilling tools and 18 mm diameter extensions reduces the overall weight by up to 15%.

- We recommend that Drill Connect be cleaned of concrete dust and lubricated with grease at regular intervals (Grease – Part-no. 4932352273).
- Drill Connect is only suitable for drilling tools in excess of 32 mm diameter and limited for use with rotary hammers up to 8 kg in weight.

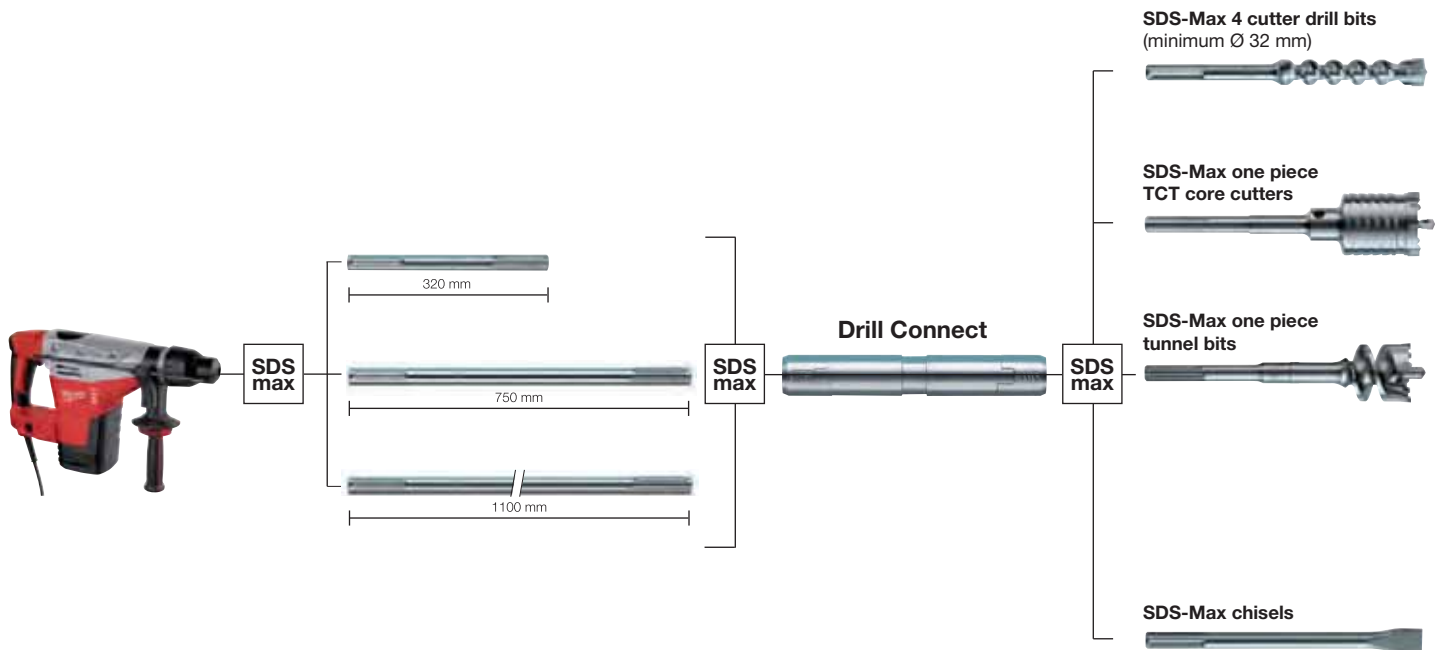

Drill Connect

Suitable for use with drilling tools with a Ø of 32 mm and above.
For use with rotary hammers up to 8 kg in weight.

Description	Tool reception	Drill connect reception	Total length (mm) A	Pack quantity	Min. order quantity	Article Number	EAN Code
Drill connect.	SDS-Max	SDS-Max	190	1	1	4932399128	4002395357321

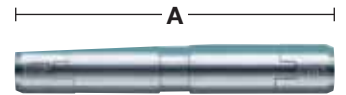

Extension pieces

Description	Tool reception	Drill connect reception	Length (mm) A	Pack quantity	Min. order quantity	Article Number	EAN Code
SDS-Max extension.	SDS-Max	SDS-Max	320	1	1	4932399242	4002395358533
SDS-Max extension.	SDS-Max	SDS-Max	750	1	1	4932399129	4002395357338
SDS-Max extension.	SDS-Max	SDS-Max	1100	1	1	4932399243	4002395358540

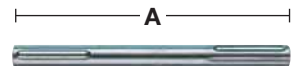

Grease

This grease has been especially formulated to lubricate and protect both the tool and accessories ensuring increased lifetime.

Apply sparingly directly onto the reception of the drill bit, chisel or core cutter, etc.
Contains 50 grams.

Description	Pack quantity	Min. order quantity	Article Number	EAN Code
Grease.	1	1	4932352273	4002395369324
Counter display with 15 x single grease tube 4932352273.	15	1	4932459598	4058546027704



Chisels

Every chisel comes with 150 years experience in manufacturing expertise, we know what it takes to make the best chisel. A high quality chisel needs to withstand the daily routine of breaking and demolition on the worksite, this demands a chisel with a low wear rate, impact strength and elasticity to have a low risk of breaking.

With these objectives in mind great attention is placed on sourcing the correct raw materials and to use the most up to date manufacturing techniques.

For the base material a specifically defined alloy steel is chosen, then each chisel is crafted individually through the production process of forging, sharpening, hardening, tempering and finishing.

The chisels are precision formed using traditional forging skills coupled with sophisticated machinery for the specific tip design.

The heat treatment process is totally enclosed and computer controlled ensuring consistent results, this guarantees that the complete chisel is hardened throughout to 55 HRC. The tempering operation creates a uniform hardened surface across the complete chisel to give it impact strength, more wear resistance and the required elasticity.

The chisels then go through the final finishing process which gives the chisel a smooth grain flow surface and a special corrosion resistant treatment.

Finally for identification purposes the Milwaukee® logo is laser marked on the chisel.

To achieve long service life all our chisels can be resharpened time and time again.

These chisels stand for 100% quality – Made in Germany.

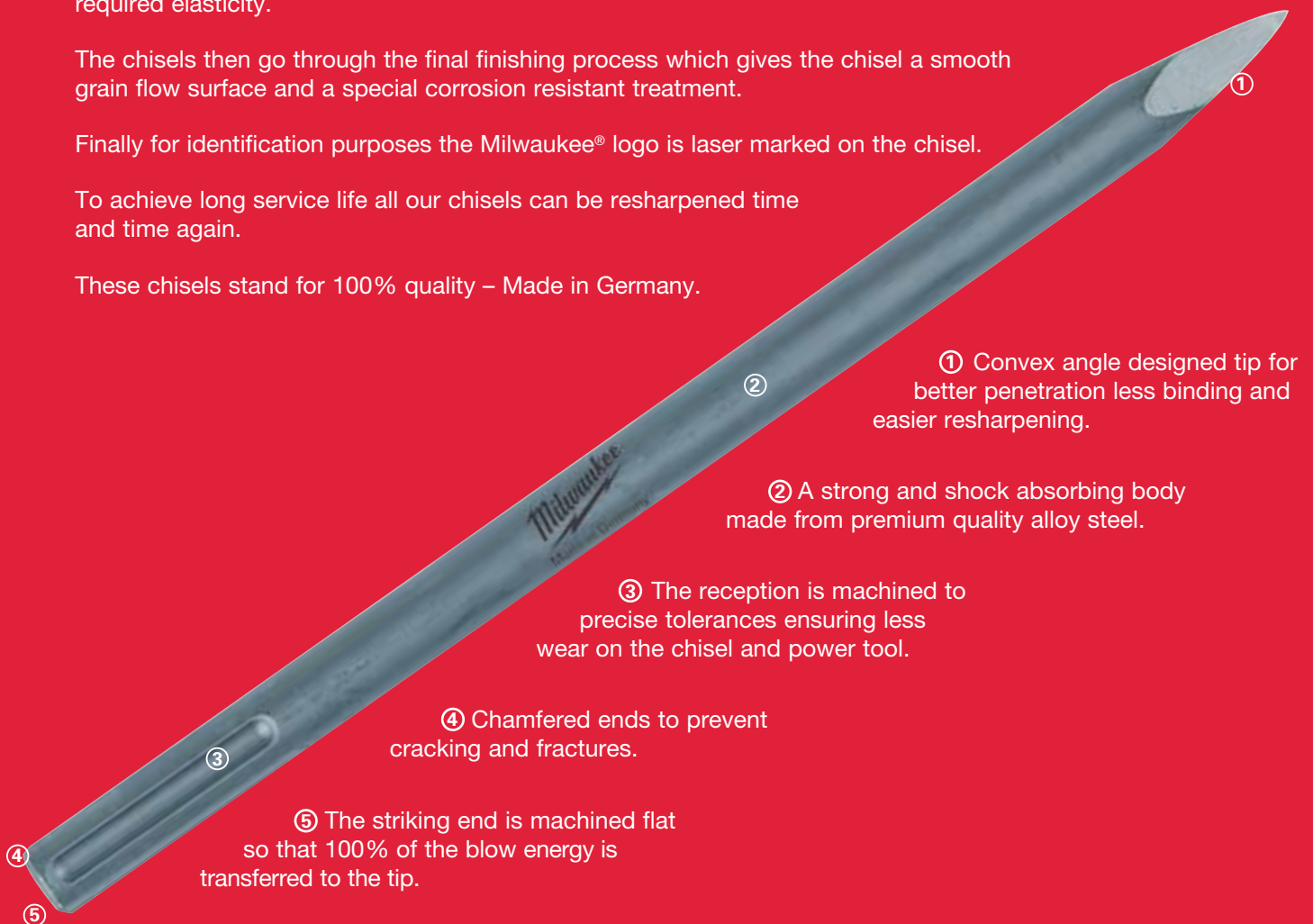

Maintenance Tips

1. Grease the reception regularly (Milwaukee® grease part no. 4932352273).
2. Keep receptions clean from dust.
3. Do not exert excessive side pressure on the chisel. Do not use as a crowbar.
4. Do not store chisels outdoors at temperatures below freezing, if so chisels should be warmed before use. Rusty chisels are more likely to suffer fatigue failure.

SDS-Plus chisels

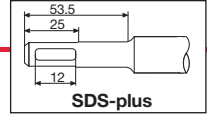

SDS-Plus thin pointed chisels

Thin chisels optimized for cordless tools (max 5J)
 Double length of forged working end compared to standard chisels for longer tool life.
 Solid 10 mm diameter along the full length of the chisel for best durability.
 Easy to handle for overhead work or in narrow working conditions.



Total length (mm) A	Blade width (mm)	Pack quantity	Min. order quantity	Article Number	EAN Code
180	-	1	1	4932451731	4002395276813

SDS-Plus pointed chisels

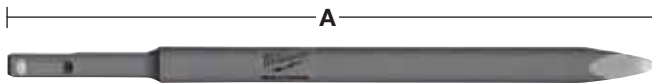

Total length (mm) A	Blade width (mm)	Pack quantity	Min. order quantity	Article Number	EAN Code
250	-	1	1	4932339625	4002395304813

SDS-Plus HP pointed chisel Self Sharpening

Up to 2x longer life vs standard chisels.
 Lengthened tip provides longer lifetime.
 Tip maintains shape throughout its life minimising the need for re-sharpening.
 Reinforced head maintains head shape over life of bit.
 Provides self-sharpening action and maintains productivity level by efficiently breaking material.

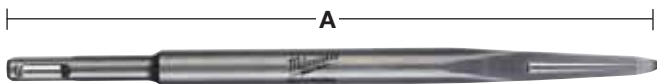

Total length (mm) A	Blade width (mm)	Pack quantity	Min. order quantity	Article Number	EAN Code
250	-	1	1	4932459279	4058546002459

SDS-Plus thin flat chisels

Thin chisels optimized for cordless tools (max. 5J)
 Double length of forged working end compared to standard chisels for longer tool life.
 Solid 10 mm diameter along the full length of the chisel for best durability.
 Easy to handle for overhead work or in narrow working conditions.

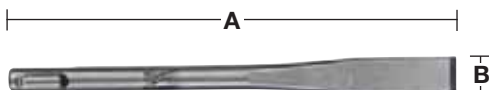

Total length (mm) A	Blade width (mm) B	Pack quantity	Min. order quantity	Article Number	EAN Code
180	14	1	1	4932451732	4002395276820

SDS-Plus chisels

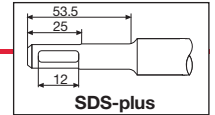

SDS-Plus flat chisels

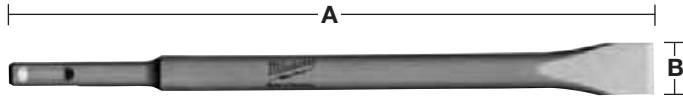

Total length (mm) A	Blade width (mm) B	Pack quantity	Min. order quantity	Article Number	EAN Code
250	20	1	1	4932339626	4002395304820

SDS-Plus HP flat chisel Self Sharpening

Up to 2x longer life vs standard chisels.
 Lengthened tip provides longer lifetime.
 Tip maintains shape throughout its life minimising the need for re-sharpening.
 Reinforced head maintains head shape over life of bit.
 Provides self-sharpening action and maintains productivity level by efficiently breaking material.

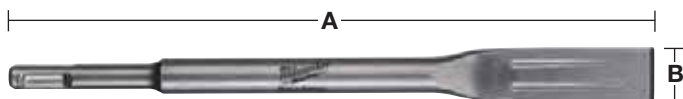

Total length (mm) A	Blade width (mm) B	Pack quantity	Min. order quantity	Article Number	EAN Code
250	20	1	1	4932459280	4058546002466

SDS-Plus wide chisels

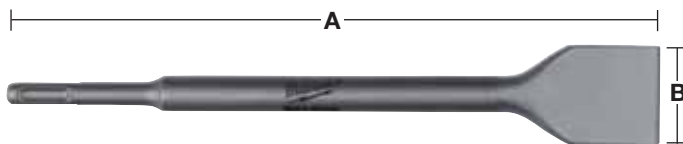

Total length (mm) A	Blade width (mm) B	Pack quantity	Min. order quantity	Article Number	EAN Code
250	40	1	1	4932367146	4002395334377

SDS-Plus chisel sets



Description	Pack quantity	Min. order quantity	Article Number	EAN Code
3 pc chisel set (250 mm length). 1 x Pointed chisel, 1 x Flat chisel, 1 x Wide chisel.	3	1	4932430001	4002395376629

SDS-Plus chisels

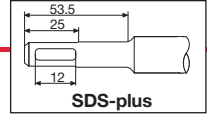

SDS-Plus tile removal chisels

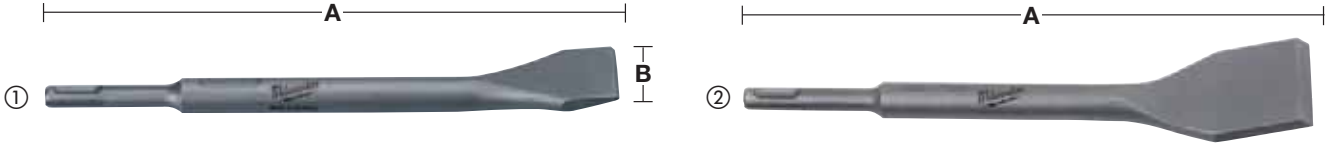

Angled head to prevent damage to walls when removing tiles.

	Total length (mm) A	Blade width (mm) B	Pack quantity	Min. order quantity	Article Number	EAN Code
①	250	40	1	1	4932353424	4002395320202
②	250	50	1	1	4932352343	4002395370023

SDS-Plus gouge chisels

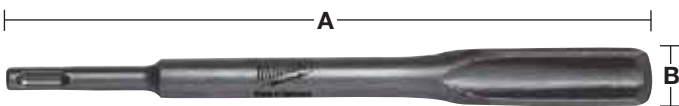

	Total length (mm) A	Blade width (mm) B	Pack quantity	Min. order quantity	Article Number	EAN Code
	250	25	1	1	4932339627	4002395304837

SDS-Plus plaster removal chisels

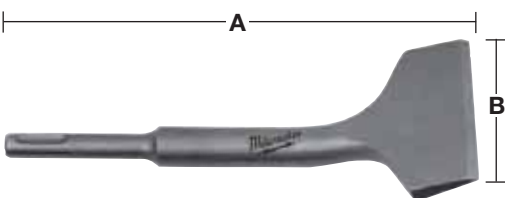

	Total length (mm) A	Blade width (mm) B	Pack quantity	Min. order quantity	Article Number	EAN Code
	165	75	1	1	4932352344	4002395370030

SDS-Plus floor / wall scrapers

For scraping adhesives, paint, scree and soft plaster.

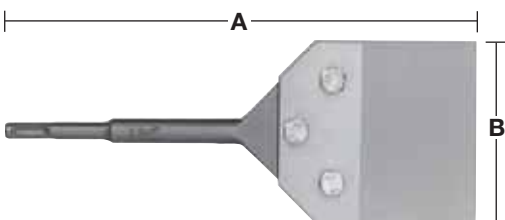

Description	Total length (mm) A	Width (mm) B	Pack quantity	Min. order quantity	Article Number	EAN Code
Floor cleaning tool complete.	250	100	1	1	4932352919	4002395375776
Spare 1 mm thick blade with 3 x bolts / nuts.			1	1	4932352920	4002395375783

SDS-Max chisels

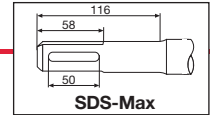

SDS-Max HP pointed chisel Self Sharpening

Up to 2x longer life vs standard chisels.
 Lengthened tip provides longer lifetime.
 Tip maintains shape throughout its life minimising the need for re-sharpening.
 Reinforced head maintains head shape over life of bit.
 Provides self-sharpening action and maintains productivity level by efficiently breaking material.



Total length (mm) A	Blade width (mm)	Pack quantity	Min. order quantity	Article Number	EAN Code
400	-	1	1	4932459281	4058546002473
400	-	20	1	4932459342	4058546010034

SDS-Max pointed chisels

Ideal for a wide range of breaking and demolition work of concrete or breeze block.

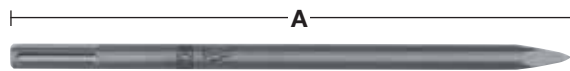

Total length (mm) A	Blade width (mm)	Pack quantity	Min. order quantity	Article Number	EAN Code
280	-	1	1	4932343734	4002395317509
400	-	1	1	4932343735	4002395317516
400	-	20	1	4932399302	4002395359165
600	-	1	1	4932343736	4002395317523

SDS-Max HP flat chisel Self Sharpening

Up to 2x longer life vs standard chisels.
 Lengthened tip provides longer lifetime.
 Tip maintains shape throughout its life minimising the need for re-sharpening.
 Reinforced head maintains head shape over life of bit.
 Provides self-sharpening action and maintains productivity level by efficiently breaking material.

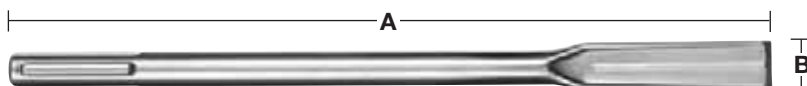

Total length (mm) A	Blade width (mm) B	Pack quantity	Min. order quantity	Article Number	EAN Code
400	25	1	1	4932459282	4058546002480
400	25	20	1	4932459343	4058546010041

SDS-Max chisels

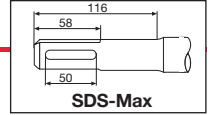

SDS-Max flat chisels

Ideal for a wide range of breaking and cutting of concrete as well as demolition work.

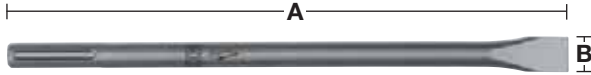

Total length (mm) A	Blade width (mm) B	Pack quantity	Min. order quantity	Article Number	EAN Code
280	25	1	1	4932343737	4002395317530
400	25	1	1	4932343738	4002395317547
400	25	20	1	4932399303	4002395359172
600	25	1	1	4932343739	4002395317554

PCHDE - Universal chiselling dust extraction system

Universal dust extraction solution fitting to all brands of SDS-Max hammers.

Collects over 90% of chiselled dust.

Saves valuable post cleaning time.

Fits to Milwaukee[®] vacs with easy and secure click system.

Can only be used with DE type chisels listed below. The following spare parts are available for a quick turnaround: spring (4931328988), rubber rings (5 pcs) (4931455278), main housing (4931449576) and front hose with plastic nose (4931455277)



Description	Pack quantity	Min. order quantity	Article Number	EAN Code
PCHDE. Includes 1 x SDS-Max point chisel.	1	1	4932455280	4002395247943
PCHDE. Includes 1 x SDS-Max flat chisel.	1	1	4932455275	4002395247936
SDS-Max DE point chisel 400 mm long.	1	1	4932455144	4002395247981
SDS-Max DE flat chisel 400 mm long.	1	1	4932455145	4002395247974

SDS-Max wide chisels

Stripping walls of plaster, ceramic tiles. Removing heavy deposits of rust and scale metal.

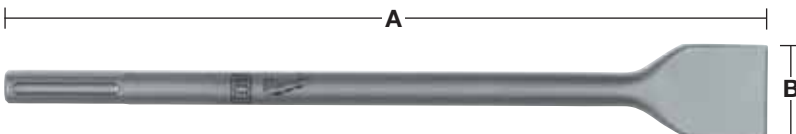

Total length (mm) A	Blade width (mm) B	Pack quantity	Min. order quantity	Article Number	EAN Code
400	50	1	1	4932343743	4002395317592
300	80	1	1	4932343744	4002395317608
300	115	1	1	4932343745	4002395317615

SDS-Max tile removal chisels

Cranked for stripping walls of plaster and ceramic tiles.

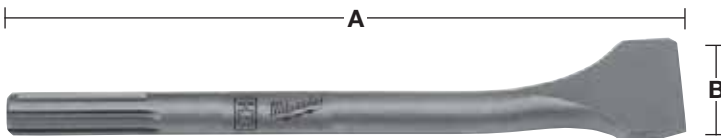

Total length (mm) A	Blade width (mm) B	Pack quantity	Min. order quantity	Article Number	EAN Code
300	80	1	1	4932399234	4002395358489

SDS-Max chisels

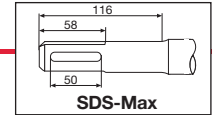

SDS-Max chasing gouge chisels

Cutting grooves into a wall surface to hold pipe work or electrical conduit. Suitable for brick, breeze block and concrete.

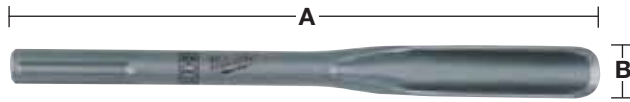

Total length (mm) A	Blade width (mm) B	Pack quantity	Min. order quantity	Article Number	EAN Code
300	26	1	1	4932343740	4002395317561

SDS-Max spade chisels

Pointed end for digging harder ground such as chalk, shingle or shale.

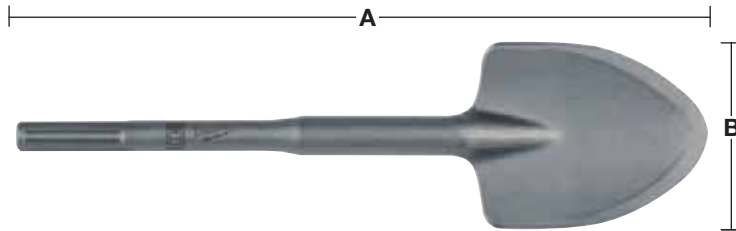

Total length (mm) A	Blade width (mm) B	Pack quantity	Min. order quantity	Article Number	EAN Code
400	110	1	1	4932343747	4002395317639

SDS-max surface treatment / bushing tools

For roughing up concrete before its surface coated ie. for pitted or uneven floors or walls must often be roughened up prior to covering with a new layer of coating.

16 teeth.

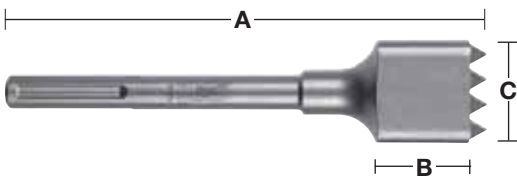

Total length (mm) A	Working length (mm) B	Working height (mm) C	Pack quantity	Min. order quantity	Article Number	EAN Code
240	50	50	1	1	4932352918	40023953175769

SDS-Max electrode / ground rod drivers

Suitable for driving hammering electrode / ground rods. Not suitable for driving rebar or steel rods.

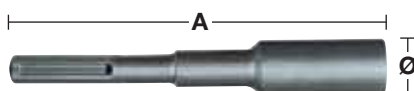

Diameter (mm)	Total length (mm) A	Pack quantity	Min. order quantity	Article Number	EAN Code
13.3	220	1	1	4932451354	4002395159031
16.6	220	1	1	4932451355	4002395159048
22.2	220	1	1	4932451356	4002395159055

28 mm K-Hexagon chisels

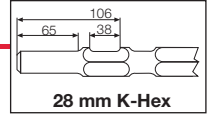

28 mm K-Hex pointed chisel

NEW

For demolition work and creating openings and breakthrough holes. The tip has defined edges which improves concrete breakage and prevents jamming.

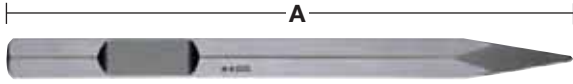

Total length (mm) A	Blade width (mm)	Pack quantity	Min. order quantity	Article Number	EAN Code
400	-	1	1	4932459774	4058546029463

28 mm K-Hex flat chisel

NEW

For demolition work and creating openings and breakthrough holes.



Total length (mm) A	Blade width (mm) B	Pack quantity	Min. order quantity	Article Number	EAN Code
400	35	1	1	4932459775	4058546029470

28 mm K-Hex flat wide chisel

NEW

80mm wide chisel suitable for removing and scraping concrete and mortar.

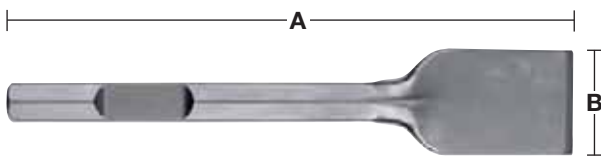

Total length (mm) A	Blade width (mm) B	Pack quantity	Min. order quantity	Article Number	EAN Code
400	80	1	1	4932459776	4058546029487

28 mm K-Hex spade chisel

NEW

For general landscaping work and road construction i.e. digging in hard compacted soil, clay and gravel.

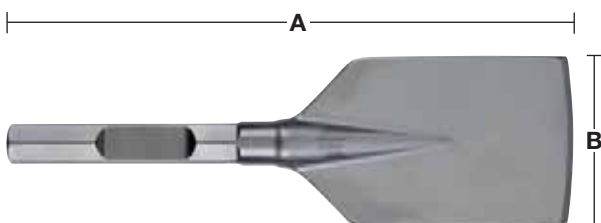

Total length (mm) A	Blade width (mm) B	Pack quantity	Min. order quantity	Article Number	EAN Code
400	125	1	1	4932459777	4058546029494

28 mm K-Hexagon chisels

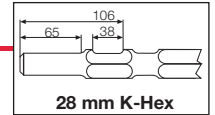

28 mm K-Hex asphalt cutter

NEW

For cutting into asphalt in road construction and hard soil.

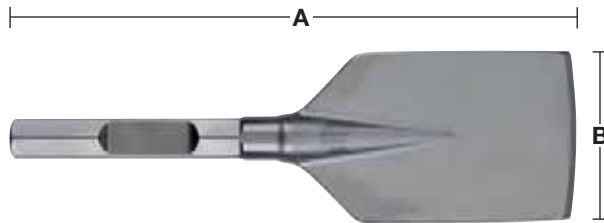

Total length (mm) A	Blade width (mm) B	Pack quantity	Min. order quantity	Article Number	EAN Code
400	90	1	1	4932459778	4058546029500

28 mm K-Hex taper tool holder

NEW

Tool holder for tamping plate.



Description	Pack quantity	Min. order quantity	Article Number	EAN Code
28 mm K-Hex taper tool holder.	1	1	4932459779	4058546029517

28 mm K-Hex tamping plate

NEW

For compacting soil, sand, gravel, ballast and crushed asphalt.

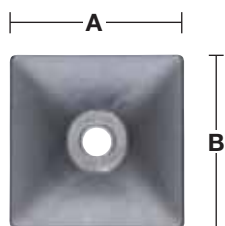

Total length (mm) A	Blade width (mm) B	Pack quantity	Min. order quantity	Article Number	EAN Code
200	200	1	1	4932459780	4058546029524

21 mm K-Hexagon chisels

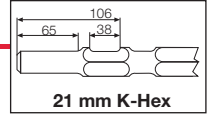

21 mm K-Hex pointed chisels

Ideal for a wide range of breaking and demolition work of concrete or breeze block.

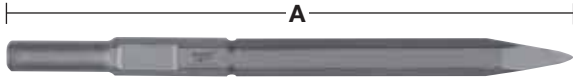

Total length (mm) A	Blade width (mm)	Pack quantity	Min. order quantity	Article Number	EAN Code
380	-	1	1	4932399251	4002395358632
450	-	1	1	4932399252	4002395358649
600	-	1	1	4932399253	4002395358656

21 mm K-Hex flat chisels

Ideal for a wide range of breaking and cutting of concrete as well as demolition work.

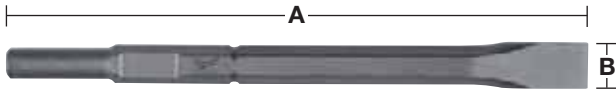

Total length (mm) A	Blade width (mm) B	Pack quantity	Min. order quantity	Article Number	EAN Code
380	25	1	1	4932399256	4002395358687
450	25	1	1	4932399257	4002395358694
600	25	1	1	4932399258	4002395358700

21 mm K-Hex wide chisels

Suitable for stripping walls of plaster or ceramic tiles. Removing heavy deposits of rust and scale from metal.

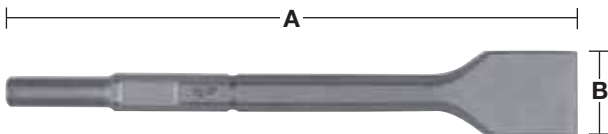

Total length (mm) A	Blade width (mm) B	Pack quantity	Min. order quantity	Article Number	EAN Code
300	50	1	1	4932399260	4002395358724
300	75	1	1	4932399261	4002395358731

21 mm K-Hexagon chisels

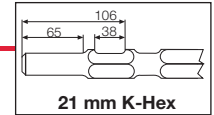

21 mm K-Hex spade chisels

Suitable for digging in all types of ground - clay, earth, chalk, shingle and shale. Also for digging in frozen ground. Not suitable for concrete.

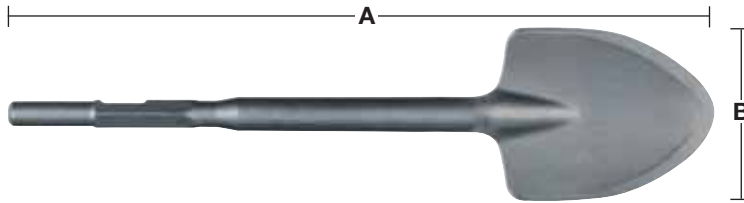

Total length (mm) A	Blade width (mm) B	Pack quantity	Min. order quantity	Article Number	EAN Code
533	110	1	1	4932399264	4002395358762

21 mm K-Hex electrode / ground rod drivers

Suitable for driving hammering electrode / ground rods. Not suitable for driving rebar or steel rods.

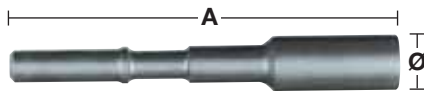

Diameter (mm)	Total length (mm) A	Pack quantity	Min. order quantity	Article Number	EAN Code
12	222	1	1	4932399265	4002395358779
16	222	1	1	4932399266	4002395358786
25	222	1	1	4932399269	4002395358816

Dust guard

Prevents dust and dirt entering the tool reception area when using spades and ground rod drivers.



Description	Pack quantity	Min. order quantity	Article Number	EAN Code
Dust guard cap.	1	1	9170086960	4002395565504

21 mm K-Hex / SDS-Max special application tools

Tamping tools

Application: Suitable for compacting earth and ballast prior to pouring concrete. Tamping back-fill on ditches. Requires universal taper shank.

Description	Width (mm) A	Working length (mm) B	Pack quantity	Min. order quantity	Article Number	EAN Code
Tamping plate.	120	120	1	1	4932399270	4002395358823

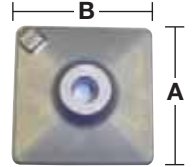

Surface treatment tools

Application: For roughing up concrete before its surface coated i.e. for pitted or uneven floors or walls must often be roughened prior to covering with a new layer of coating. Requires universal taper shank.

Description	Length (mm) A	Width (mm) B	Pack quantity	Min. order quantity	Article Number	EAN Code
Bushing head (16 teeth).	50	50	1	1	4932399279	4002395358915

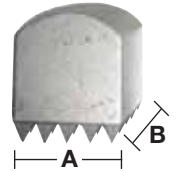

Floor cleaning tools

Application: For scraping floor tile adhesive, paint, scree and other floor coatings. Requires universal taper shank.

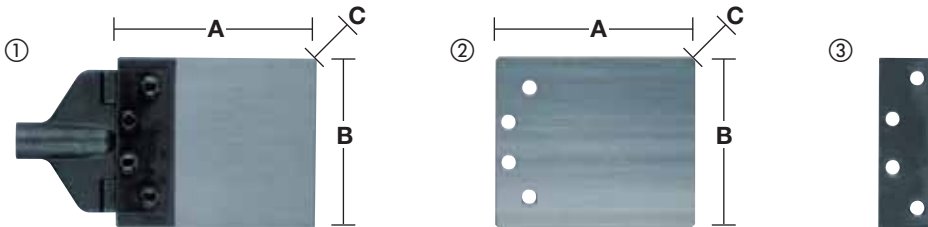









Description	Blade length (mm) A	Blade width (mm) B	Thickness (mm) C	Pack quantity	Min. order quantity	Article Number	EAN Code
① Floor cleaning tool including 2 mm blade. Requires universal taper shank.	180	150	2	2	1	4932399272	4002395358847
② Spare 2 mm blade.	180	150	2	1	1	4932399273	4002395358854
③ Replacement clamping bracket.				1	1	4932399275	4002395358878
④ Service set. 2 x gasket, 4 x nuts, 4 x screws, 8 x washers.				18	1	4932352300	4002395369591

Universal taper shanks

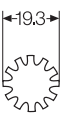
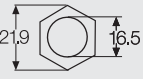
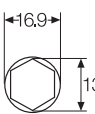
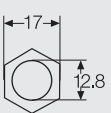
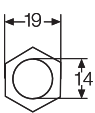

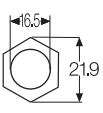
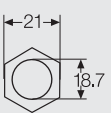
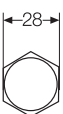
Description	Total length (mm) A	Pack quantity	Min. order quantity	Article Number	EAN Code
① Universal taper shank SDS-Max.	300	1	1	4932343771	4002395317745
② Universal taper shank 21 mm K-Hexagon.	300	1	1	4932399280	4002395358922
	450	1	1	4932399281	4002395358939

Name		Top view	Suitable for
① SDS-plus	drill		AEG, Milwaukee®, Bosch, Dewalt, Hilti, Hitachi, Kango, Makita, Ryobi
① SDS-plus	chisel		AEG, Milwaukee®, Bosch, Dewalt, Hilti, Hitachi, Kango, Makita, Ryobi
② SDS-Max	drill		AEG, Milwaukee®, Bosch, Dewalt, Hilti, Hitachi, Kango, Makita, Ryobi
② SDS-Max	chisel		AEG, Milwaukee®, Bosch, Dewalt, Hilti, Hitachi, Kango, Makita, Ryobi
③ Spline	drill		AEG, Milwaukee®, Bosch, Dewalt, Hilti, Hitachi, Kango, Makita, Metabo
④ Twisted spline	chisel		AEG, Milwaukee®, Bosch, Dewalt, Hilti, Hitachi, Kango, Makita, Metabo
⑤ 13 mm Hexagon	drill		Hitachi, Makita
⑥ 17 mm Hexagon	chisel		Hitachi, Makita
⑦ 19 mm K-Hexagon	chisel		Kango
⑧ 19 mm Hexagon	chisel		AEG, Milwaukee®, Bosch, Dewalt, Ryobi
⑨ 21 mm K-Hexagon	drill		Hitachi, Kango, Makita, Milwaukee®
⑩ 21 mm K-Hexagon	chisel		Hitachi, Kango, Makita, Milwaukee®
⑪ 28 mm K-Hexagon	chisel		AEG, Milwaukee®
⑫ 32 mm Hexagon	chisel		Atlas Copco, Kango, Milwaukee®

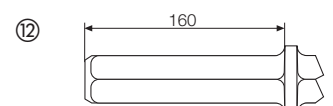
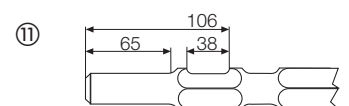
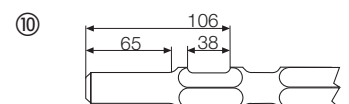
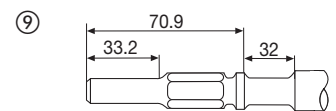
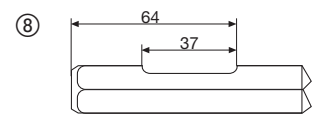
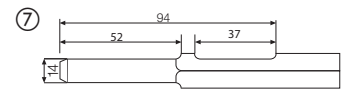
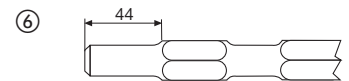
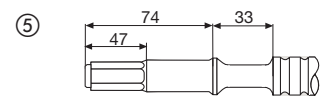
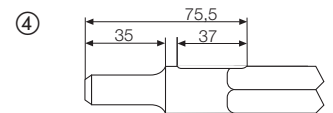
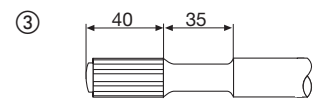
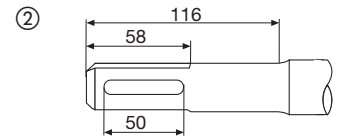
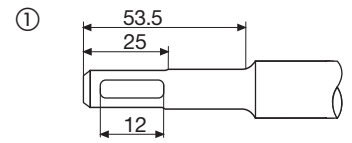

Concrete drill bits - round shank - DIN 8039

Diamond ground percussion carbide tip with two cutting edges.

For drilling in brick, tile, ceramic, concrete, plaster, slate and aerated concrete blocks.

Made in Germany.

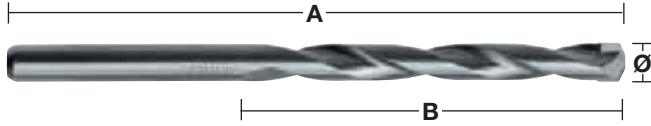

Diameter (mm)	Total length (mm) A	Working length (mm) B	Pack quantity	Min. order quantity	Article Number	EAN Code
3	70	40	1	1	4932363630	4002395332007
3.5	80	45	1	1	4932399916	4002395365746
4	85	50	1	1	4932363631	4002395332014
4.5	85	50	1	1	4932363632	4002395332021
5	85	50	1	1	4932363633	4002395332038
5	150	90	1	1	4932363634	4002395332045
5.5	85	50	1	1	4932363635	4002395332052
5.5	150	90	1	1	4932367035	4002395333998
6	100	60	1	1	4932363636	4002395332069
6	150	90	1	1	4932363637	4002395332076
6	200	150	1	1	4932399383	4002395360000
6	400	350	1	1	4932352505	4002395371631
6	600	550	1	1	4932352506	4002395371648
6.5	100	60	1	1	4932363638	4002395332083
6.5	150	90	1	1	4932367036	4002395334605
7	100	60	1	1	4932363639	4002395332090
7	150	90	1	1	4932367037	4002395334612
7.5	100	60	1	1	4932399917	4002395365753
8	120	80	1	1	4932363640	4002395332106
8	200	150	1	1	4932363641	4002395332113
8	400	350	1	1	4932399384	4002395360017
8	600	550	1	1	4932352507	4002395371655
8.5	120	80	1	1	4932363642	4002395332120
9	120	80	1	1	4932363643	4002395332137
9.5	120	80	1	1	4932399919	4002395365777
10	120	80	1	1	4932363644	4002395332144
10	200	150	1	1	4932363645	4002395332151
10	400	350	1	1	4932399385	4002395360024
10	600	550	1	1	4932352508	4002395371662
11	150	85	1	1	4932363646	4002395332168
12	150	85	1	1	4932363647	4002395332175
12	200	150	1	1	4932363648	4002395332182
12	400	350	1	1	4932399386	4002395360031
12	600	550	1	1	4932352510	4002395371686
13	150	90	1	1	4932363649	4002395332199
13	400	350	1	1	4932352512	4002395371709
14	150	90	1	1	4932363650	4002395332205
14	400	350	1	1	4932399387	4002395360048
14	600	550	1	1	4932352513	4002395371716
15	160	100	1	1	4932399380	4002395359974
16	160	100	1	1	4932373914	4002395353446
16	400	350	1	1	4932399388	4002395360055
16	600	550	1	1	4932352514	4002395371723
18	160	100	1	1	4932399229	4002395358434
18	400	350	1	1	4932352515	4002395371730
20	160	100	1	1	4932399230	4002395358441
20	400	350	1	1	4932399389	4002395360062
20	600	550	1	1	4932352516	4002395371747
22	400	350	1	1	4932352517	4002395371754

①



②



- ① **Concrete drill bit set (5 pcs).**
Ø 4 / 5 / 6 / 8 / 10 mm. 5 1 4932352333 4002395369928
- ② **Concrete drill bit set (8 pcs).**
Ø 3 / 4 / 5 / 6 / 7 / 8 / 9 / 10 mm. 8 1 4932352334 4002395369935

Concrete super drill bits - round shank - DIN 8039

These high quality concrete drill bits have a unique shaped drill head with centering point and a H-spiral flute for maximum drilling speed and longer lifetime in hard materials such as concrete, aerated concrete blocks, masonry, natural stone, artificial stone, ceramic tile, slate and granite.

From Ø 12 mm the drill bits are supplied with a multi-flat shank to prevent the drill bit slipping in the chuck.

Made in Germany.

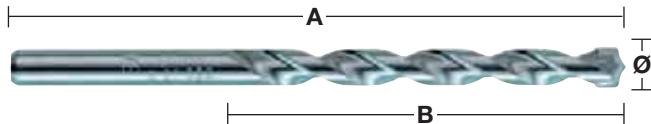

Diameter (mm)	Total length (mm) A	Working length (mm) B	Pack quantity	Min. order quantity	Article Number	EAN Code
3	70	40	1	1	4932399394	4002395360116
4	85	50	1	1	4932399395	4002395360123
5	85	50	1	1	4932399396	4002395360130
5.5	85	50	1	1	4932399397	4002395360147
6	100	60	1	1	4932399398	4002395360154
6.5	100	60	1	1	4932399399	4002395360161
7	100	60	1	1	4932399400	4002395360178
8	120	80	1	1	4932399401	4002395360185
9	120	80	1	1	4932399402	4002395360192
10	120	80	1	1	4932399403	4002395360208
12	150	90*	1	1	4932399404	4002395360215
14	150	90*	1	1	4932399405	4002395360222
15	160	100*	1	1	4932399406	4002395360239
16	160	100*	1	1	4932399407	4002395360246
18	160	100*	1	1	4932399408	4002395360253
20	160	100*	1	1	4932399409	4002395360260
① Concrete Super drill bit set (5 pcs). Ø 4 / 5 / 6 / 8 / 10 mm.			5	1	4932352336	4002395369959
② Concrete Super drill bit set (7 pcs). Ø 4 / 5 / 5.5 / 6 / 7 / 8 / 10 mm.			7	1	4932352337	4002395369966

* with multi-flat shank



Multi material drill bits

These tungsten carbide tipped (TCT) drill bits will drill in metal, wood and stone rotary mode only. Hammer action cannot be used with these drill bits. Ideal for tradesmen who need to drill through a variety of materials in one go. Made in Germany.

①

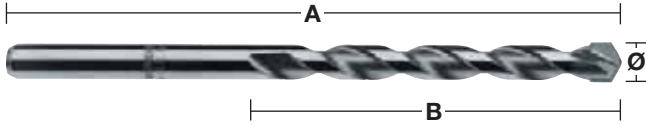

Diameter (mm)	Total length (mm) A	Working length (mm) B	Pack quantity	Min. order quantity	Article Number	EAN Code
3	70	40	1	1	4932430147	4002395378081
4	85	50	1	1	4932430148	4002395378098
5	85	50	1	1	4932430149	4002395378104
5.5	85	50	1	1	4932430150	4002395378111
5.5	150	90	1	1	4932430151	4002395378128
6	100	60	1	1	4932430152	4002395378135
6	150	90	1	1	4932430153	4002395378142
6	200	150	1	1	4932430154	4002395378159
6.5	150	90	1	1	4932430155	4002395378166
6.5	200	150	1	1	4932430156	4002395378173
7	100	60	1	1	4932430157	4002395378180
8	120	80	1	1	4932430158	4002395378197
8	250	200	1	1	4932430159	4002395378203
10	120	80	1	1	4932430160	4002395378210
10	250	200	1	1	4932430161	4002395378227
12	150	90	1	1	4932430162	4002395378234
① Multi material drill bit set (7 pcs). Ø 3 / 4 / 5 / 6 / 6 / 8 / 10 mm.			7	1	4932352335	4002395369942
Multi material drill bit set (7 pcs). Ø 4 / 5 / 5.5 / 6 / 7 / 8 / 10 mm.			7	1	4932352836	4002395374946

Glass & tile bits

Suitable for glass, tiles, mirrors, ceramics. Made in Germany.

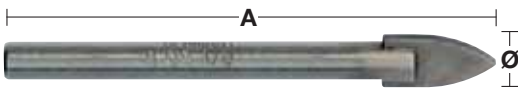

Diameter (mm)	Total length (mm) A	Pack quantity	Min. order quantity	Article Number	EAN Code
3	90	1	1	4932399393	4002395360109
4	90	1	1	4932363884	4002395333585
5	90	1	1	4932363885	4002395333592
6	90	1	1	4932363886	4002395333608
8	95	1	1	4932363887	4002395333615
10	100	1	1	4932363888	4002395333622

Impact rated wood auger bits

Suitable for use with all types of corded / cordless drills including impact wrenches.
 Drilling with an impact wrench enables drilling holes with less effort, one hand drilling, drilling up a ladder and above head height with less risk of injury from the tool clutching out.
 Special zone hardening process ensures an extra hard shank, durable tip and perfectly flexible bit body.
 New Milwaukee® Through-Center head geometry with the lead cutting edge lines up with the center of the feed screw.
 This ensures efficient chip removal and allows for continuous feeding.
 20° rake angle of the lead cutting edge creates a path for easy chip ejection.
 Polished and powder coated flute design produces a non-stick surface for increased chip ejection, reduced chip clogging and higher selffeeding capability.
 Milling marks are removed in the finishing process, creating a smooth surface.
 Lewis flute with large, wide throat design for rapid chip removal.
 Sharp ground cutting lips for smooth clean holes.
 Resharpenable cutting lips.
 With 7/16" shank. To fit square drive 1/2" impact wrenches the adaptor 48660061 is required.
 Suitable for hard & soft wood, wet & treated wood, plywood, chipboard, WPC (wood plastic composite), laminated beams and panels, exotic and hard woods e.g. bongossi, iroko, teak, beech, oak, etc.



Short series

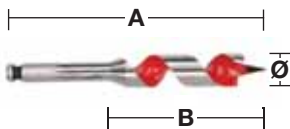

Special short design enables drilling in tight and normally non accessible places.

Diameter (mm)	Total length (mm) A	Working length (mm) B	Shank reception	Pack quantity	Min. order quantity	Article Number	EAN Code
18	153	100	7/16" Hex	1	1	48130683	045242091379
20	153	100	7/16" Hex	1	1	48130813	045242091522
22	153	100	7/16" Hex	1	1	48130873	045242091638
25	153	100	7/16" Hex	1	1	48131003	045242091782
28	153	100	7/16" Hex	1	1	48131123	045242091935
32	153	100	7/16" Hex	1	1	48131253	045242092031

Long series

NEW

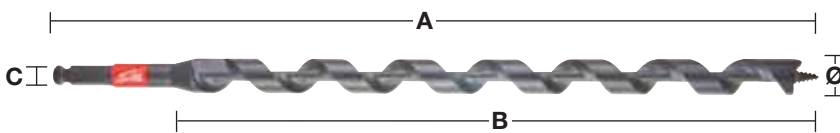

SHOCKWAVE
IMPACT DUTY

Diameter (mm)	Total length (mm) A	Working length (mm) B	Shank reception	Pack quantity	Min. order quantity	Article Number	EAN Code
14	470	395	7/16" Hex	1	1	48136754	045242518999
16	470	395	7/16" Hex	1	1	48136756	045242519002
18	470	395	7/16" Hex	1	1	48136758	045242004089
19	460	395	7/16" Hex	1	1	48136759	045242519019
20	470	395	7/16" Hex	1	1	48136760	045242004096
22	470	395	7/16" Hex	1	1	48136762	045242519033
26	470	395	7/16" Hex	1	1	48136766	045242004102
29	460	395	7/16" Hex	1	1	48136769	045242519057

4 pc set in pouch.

Ø 14 / 16 / 18 / 20 x 460 mm.

4 1 48136780 045242005383

System accessories

Description	Pack quantity	Min. order quantity	Article Number	EAN Code
-------------	---------------	---------------------	----------------	----------

Adaptor: 1/2" square drive to 7/16" and Hex 11 mm. For use with 7/16" selffeed bits and impact auger bits.

1 1 48660061 045242155118



Wood drilling speeds

The following tables give recommended drilling speeds for the most efficient cutting speed. The tables should only be used as a guide and are dependant on the user and material being drilled.

Auger bits

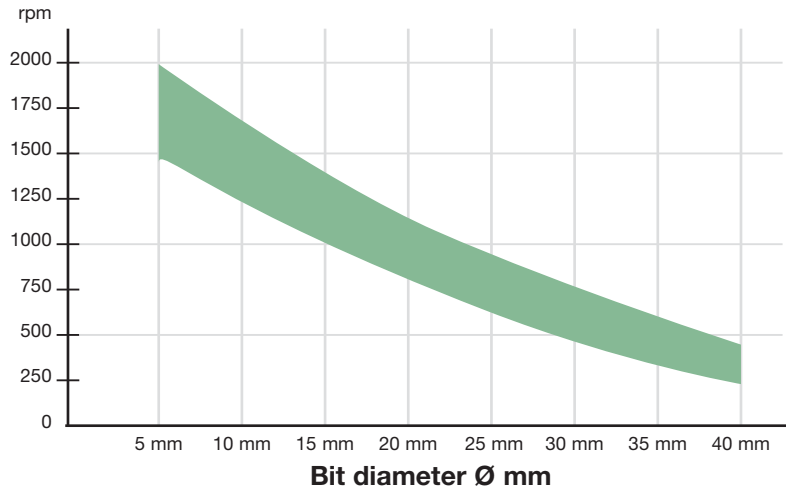

Optimum drilling speed range in rpm



Forstner bits / Selffeed bits

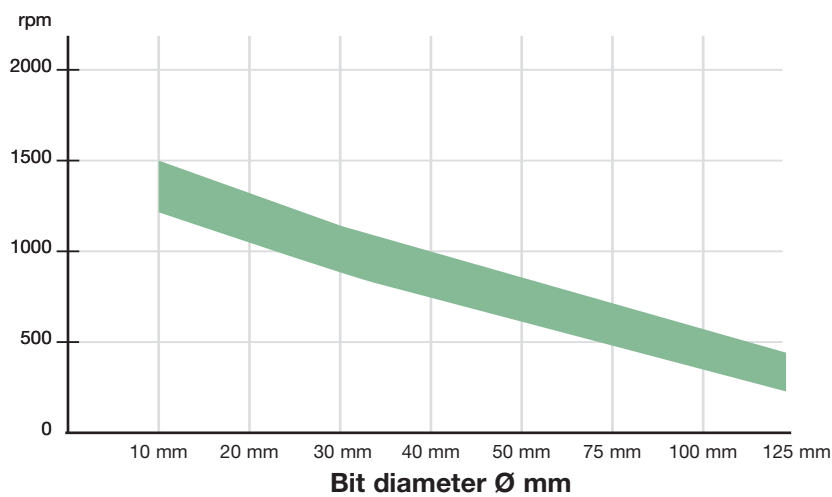

Optimum drilling speed range in rpm



Wood auger bits

For heavy duty, precision drilling in soft and hard wood, large section beams, joists, floor boarding, chipboard and plywood.
Lewis flute design for rapid chip removal.
With Hex shank for secure chuck grip.

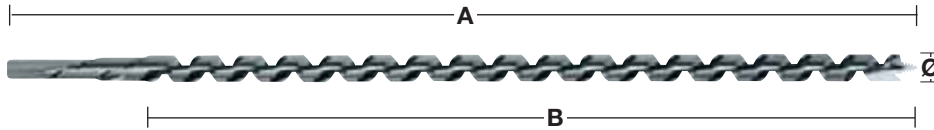

Diameter (mm)	Total length (mm) A	Working length (mm) B	Shank reception	Pack quantity	Min. order quantity	Article Number	EAN Code	
6	230	155	6.5 mm Hex	1	1	4932430175	4002395378364	
6	460	385	6.5 mm Hex	1	1	4932430176	4002395378371	
8	230	155	6.5 mm Hex	1	1	4932363681	4002395331796	
8	460	385	6.5 mm Hex	1	1	4932363688	4002395331710	
10	230	155	8.5 mm Hex	1	1	4932363682	4002395331802	
10	460	385	8.5 mm Hex	1	1	4932363689	4002395331727	
10	600	530	8.5 mm Hex	1	1	4932363696	4002395331642	
12	230	155	10 mm Hex	1	1	4932363683	4002395331819	
12	460	385	10 mm Hex	1	1	4932363690	4002395331734	
12	600	530	10 mm Hex	1	1	4932363697	4002395331659	
14	230	155	11 mm Hex	1	1	4932363684	4002395331826	
14	460	385	11 mm Hex	1	1	4932363691	4002395331741	
14	600	530	11 mm Hex	1	1	4932363698	4002395331666	
16	230	155	11 mm Hex	1	1	4932363685	4002395331833	
16	460	385	11 mm Hex	1	1	4932363692	4002395331758	
16	600	530	11 mm Hex	1	1	4932363699	4002395331673	
18	230	155	11 mm Hex	1	1	4932363686	4002395331840	
18	460	385	11 mm Hex	1	1	4932363693	4002395331765	
18	600	530	11 mm Hex	1	1	4932363700	4002395331680	
20	230	155	11 mm Hex	1	1	4932363687	4002395331857	
20	460	385	11 mm Hex	1	1	4932363694	4002395331772	
20	600	530	11 mm Hex	1	1	4932363701	4002395331697	
22	230	155	11 mm Hex	1	1	4932373363	4002395347889	
22	460	385	11 mm Hex	1	1	4932363695	4002395331789	
22	600	530	11 mm Hex	1	1	4932363702	4002395331703	
24	230	155	11 mm Hex	1	1	4932373364	4002395347896	
24	460	385	11 mm Hex	1	1	4932373370	4002395348558	
26	230	155	11 mm Hex	1	1	4932373365	4002395348503	
26	460	385	11 mm Hex	1	1	4932373371	4002395348565	
28	230	155	11 mm Hex	1	1	4932373366	4002395348510	
28	460	385	11 mm Hex	1	1	4932373372	4002395348572	
30	230	155	11 mm Hex	1	1	4932373367	4002395348527	
30	460	385	11 mm Hex	1	1	4932373373	4002395348589	
32	230	155	11 mm Hex	1	1	4932373368	4002395348534	
32	460	385	11 mm Hex	1	1	4932373374	4002395348596	
Wood auger bits 6 pcs. ① Ø 8 / 10 / 12 / 14 / 16 / 18 mm x 230 mm.				Wood case	6	1	4932373380	4002395349258



Forstner bits

Centre point for precisely locating the bit, peripheral cutters ensure splinter free drilling in all natural soft and hard woods. Manufactured according to DIN 74836. Suitable for heavy-duty applications in all naturals, soft and hard woods.

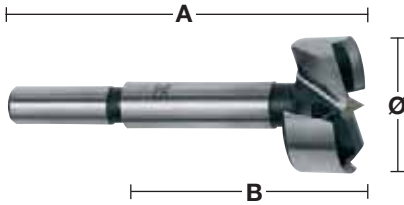

Diameter (mm)	Total length (mm) A	Working length (mm) B	Shank reception	Pack quantity	Min. order quantity	Article Number	EAN Code
10	90	50	8 mm round shank	1	1	4932363703	4002395331468
12	90	50	8 mm round shank	1	1	4932363704	4002395331475
14	90	50	8 mm round shank	1	1	4932363705	4002395331482
15	90	50	8 mm round shank	1	1	4932363883	4002395333738
16	90	50	8 mm round shank	1	1	4932363706	4002395331499
18	90	50	8 mm round shank	1	1	4932363707	4002395331505
20	90	50	8 mm round shank	1	1	4932363708	4002395331512
25	90	50	8 mm round shank	1	1	4932363711	4002395331543
26	90	50	8 mm round shank	1	1	4932363712	4002395331550
30	90	50	8 mm round shank	1	1	4932363714	4002395331574
32	90	50	10 mm round shank	1	1	4932363715	4002395331581
35	90	50	10 mm round shank	1	1	4932363717	4002395331604
40	90	50	10 mm round shank	1	1	4932363720	4002395331635
50	90	50	10 mm round shank	1	1	4932373923	4002395353538
Forstner 5 piece drill bit set.							
① Ø 15 / 20 / 25 / 30 / 35 mm.				5	1	4932373379	4002395349241

SWITCHBLADE™ Selffeed bits

- **Speed:** aggressive feed screw design allows the bit to pull through the wood faster and without effort, resulting in faster drilling.
- **Replaceable SWITCHBLADE™:** The SWITCHBLADE™ replaceable blade system ensures your blade is always razor sharp. It increases productivity by eliminating resharpening downtime and it increases the overall life of the bit.
- **Application:** suitable for all general contractors, electricians, plumbers and HVAC engineers who require to drill through holes in wood for all types of pipe, vents and wire trunking.
- Each Selffeed bit is supplied with 2x blades, 2x replaceable feed screws, 2x set screws and 1x allen key.



Diameter (mm)	Shank reception	Pack quantity	Min. order quantity	Article Number	EAN Code
35	7/16" Hex	1	1	48255120	045242157471
38	7/16" Hex	1	1	48255125	045242157488
51	7/16" Hex	1	1	48255135	045242157495
54	7/16" Hex	1	1	48255140	045242157525
57	7/16" Hex	1	1	48255143	045242225903
65	7/16" Hex	1	1	48255150	045242157532



SWITCHBLADE™ 5 piece kit

Description	Pack quantity	Min. order quantity	Article Number	EAN Code
SWITCHBLADE™ 5 pc set.				
4 SWITCHBLADE™ Selffeed bits: Ø 35 / 38 / 54 / 65 mm, QUIK-LOK extension 140 mm length, 4 x Replacement SWITCHBLADE™ blades (1 for each size bit), 4 x Feed screws, 4 x Set screws, 1 x Allen key.	5	1	49225100	045242157686



SWITCHBLADE™ replacement blades

Diameter (mm)	Pack quantity	Min. order quantity	Article Number	EAN Code
35	1	1	48255420	045242225842
38	1	1	48255425	045242225859
51	1	1	48255435	045242225866
54	1	1	48255440	045242225873
57	1	1	48255443	045242225880
65	1	1	48255450	045242226474

Service kit in storage container.

1 x feed screw, 2 x set screws, 1 x allen key, 1 x storage container also can store spare SWITCHBLADE™.



Selfeed Bits

All sizes have removable and replaceable feed screws.
 Two feed screws supplied with each bit.
 Feed screw provides fast, effortless feeding even in gummy woods.
 Internal cutting plane shaves hole radius for clean, smooth holes without pressure.
 Each selfeed bit is supplied with 2 x feed screws, 1 x set screw and 1 x allen key.

Diameter (mm)	Shank reception	Pack quantity	Min. order quantity	Article Number	EAN Code
25	7/16" Hex	1	1	48251002	045242119028
29	7/16" Hex	1	1	48251122	045242119073
32	7/16" Hex	1	1	48251252	045242119127
35	7/16" Hex	1	1	48251372	045242119172
38	7/16" Hex	1	1	48251502	045242119226
44	7/16" Hex	1	1	48251752	045242119271
51	7/16" Hex	1	1	48252002	045242119325
54	7/16" Hex	1	1	48252122	045242119370
57	7/16" Hex	1	1	48252252	045242119424
65	7/16" Hex	1	1	48252562	045242119479
Feed screw coarse thread 1/4".		1	1	48286870	045242122707
Allen key 1/8" for all arbors.		1	1	49960060	045242221455
Set screw for drills up to 65 mm.		1	1	06832625	-



Large selfeed drills

Large selfeed drills in 76, 92 and 116 mm sizes have double internal cutter blades that shave hole radius for clean, smooth holes without pressure.
 Replaceable arbor.

Diameter (mm)	Shank reception	Pack quantity	Min. order quantity	Article Number	EAN Code
76	3 milled flats	1	1	48253001	045242119509
92	3 milled flats	1	1	48253621	045242119554
116	3 milled flats	1	1	48254621	045242119608
Replaceable arbor.		1	1	48070201	045242088904
Feed screw regular thread.		1	1	48286880	045242122806
Set screw for drills up over 76mm.		1	1	06833150	-
Allen Key 5/32"		1	1	49960070	045242221554



7-bit contractors kit

Description	Pack quantity	Min. order quantity	Article Number	EAN Code
7 pc contractors kit.				
Selfeed bits Ø 25 / 29 / 32 / 38 / 44 / 54 / 65 mm, extension 140 mm length and feed screws.	7	1	49220130	045242180301



Shank extensions

For selfeed bits, auger bits and holesaws (25 mm / 1" diameter and larger) with 7/16" Hex shank.

Total length (mm) A	Pack quantity	Min. order quantity	Article Number	EAN Code
① 140	1	1	48281030	045242122653
300	1	1	48284006	045242122516
② 450	1	1	48284011	045242122561
600	1	1	48284016	045242122615

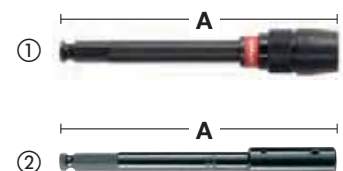

Lip & spur / brad point bits for wood - DIN 7487 E

Suitable for drilling hardboard, plywood, chipboard and all natural hard and soft wood.
Produced according to DIN 7487 E.

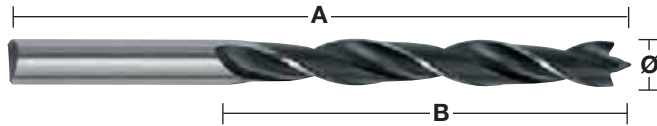

Diameter (mm)	Total length (mm) A	Working length (mm) B	Shank reception	Pack quantity	Min. order quantity	Article Number	EAN Code
3	60	33	3 mm round shank	1	1	4932363651	4002395331307
4	75	43	4 mm round shank	1	1	4932363652	4002395331314
5	86	52	5 mm round shank	1	1	4932363653	4002395331321
6	97	60	6 mm round shank	1	1	4932363654	4002395331338
7	109	69	7 mm round shank	1	1	4932363655	4002395331345
8	117	75	8 mm round shank	1	1	4932363656	4002395331352
9	125	80	9 mm round shank	1	1	4932363657	4002395331369
10	133	87	10 mm round shank	1	1	4932363658	4002395331376
11	142	89	10 mm round shank	1	1	4932363659	4002395331383
12	151	96	10 mm round shank	1	1	4932363660	4002395331390
13	151	96	10 mm round shank	1	1	4932363661	4002395331406
14	151	97	10 mm round shank	1	1	4932363662	4002395331413
15	151	97	10 mm round shank	1	1	4932363663	4002395331420
16	151	97	10 mm round shank	1	1	4932363664	4002395331437
18	180	120	10 mm round shank	1	1	4932363665	4002395331444
20	200	130	10 mm round shank	1	1	4932363666	4002395331451
① Wood drill bit set 5 pcs. Ø 4 / 5 / 6 / 8 / 10 mm.			Plastic cassette	5	1	4932352465	4002395371242
② Wood drill bit set 8 pcs. Ø 3 / 4 / 5 / 6 / 7 / 8 / 9 / 10 mm.			Plastic cassette	8	1	4932352466	4002395371259

Flat boring bits

- Fast drilling of big diameters.
- Suitable for drilling in natural hard and softwood and chipboard.
- Ideal for door locks, morticing, electrical and plumbing work.
- 1/4" Hex shank reception (DIN E 6.3) for direct insertion into the power tool or for secure chuck grip.
- Ground centre point for accurate positioning and sharp wings for improved cutting performance.

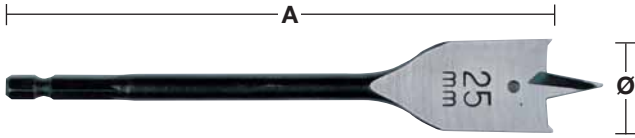

Diameter (mm)	Total length (mm) A	Pack quantity	Min. order quantity	Article Number	EAN Code
6	152	1	1	4932352487	4002395371457
6	400	1	1	4932352488	4002395371464
8	152	1	1	4932363130	4002395332618
8	400	1	1	4932352489	4002395371471
10	152	1	1	4932363131	4002395332625
10	400	1	1	4932352490	4002395371488
12	152	1	1	4932363132	4002395332632
12	400	1	1	4932352491	4002395371495
13	152	1	1	4932363133	4002395332649
13	400	1	1	4932352492	4002395371501
14	152	1	1	4932363134	4002395332656
14	400	1	1	4932352493	4002395371518
16	152	1	1	4932363135	4002395332663
16	400	1	1	4932352494	4002395371525
18	152	1	1	4932363136	4002395332670
18	400	1	1	4932352495	4002395371532
19	152	1	1	4932363137	4002395332687
19	400	1	1	4932352496	4002395371549
20	152	1	1	4932363138	4002395332694
20	400	1	1	4932352497	4002395371556
22	152	1	1	4932363139	4002395332700
22	400	1	1	4932352498	4002395371563
24	152	1	1	4932363140	4002395332717
25	152	1	1	4932363141	4002395332724
25	400	1	1	4932352499	4002395371570
26	152	1	1	4932363142	4002395332731
28	152	1	1	4932363143	4002395332748
28	400	1	1	4932352500	4002395371587
30	152	1	1	4932363144	4002395332755
30	400	1	1	4932352501	4002395371594
32	152	1	1	4932363145	4002395332762
32	400	1	1	4932352502	4002395371600
35	400	1	1	4932352503	4002395371617
36	152	1	1	4932363146	4002395332779
38	152	1	1	4932363147	4002395332786
① 8 pc Flat bit set. Ø 12 / 16 / 18 / 20 / 22 / 25 / 28 / 32 x 152 mm length.		8	1	4932352504	4002395371624

Extension

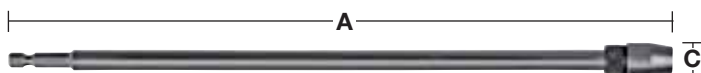

Description	Total length (mm) A	Shank reception	Tool reception	Pack quantity	Min. order quantity	Article Number	EAN Code
Extension.	305	1/4" Hex	1/4" Hex	1	1	4932363148	4002395332793

SPEED FEED™ wood drill bits

Step up from flat bit in quality and performance - faster drilling, higher lifetime and less jamming!
 Dual cutting edges for fast and aggressive cut - up to 10 times faster drilling vs. flat boring bit.
 Tapered design for reduced chip clogging, less friction and less jamming even in tough applications - results in less breakages.
 Feed screw with coarse thread increases selffeeding in all types of wood - soft & hard, wet & treated.
 Polished and powder coated flute design for increased chip ejection, reduced clogging and higher selffeeding capability.

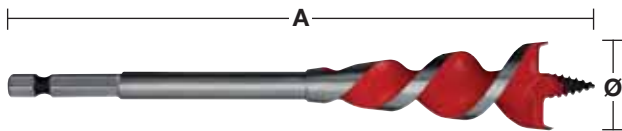

Dual cutting edges

Diameter (mm)	Ø (inch)	Total length (mm) A	Shank reception	Pack quantity	Min. order quantity	Article Number	EAN Code
13	1/2"	165	1/4" Hex	1	1	48130048	045242224807
16	5/8"	165	1/4" Hex	1	1	48130058	045242224814
18	3/4"	165	1/4" Hex	1	1	4932464071	4058546220167
20	3/4"	165	1/4" Hex	1	1	48130068	045242224821
22	7/8"	165	1/4" Hex	1	1	48130078	045242224838
25	1"	165	1/4" Hex	1	1	48130088	045242224845
32	1 1/4"	165	1/4" Hex	1	1	48130108	045242224852
4 pc set. Ø 13 / 16 / 20 / 25 mm.				4	1	48130400	045242234448

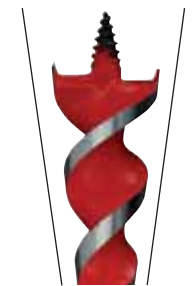

Tapered design

HSS Cable bits - DIN 7490

Manufactured from HSS steel for increased lifetime. Suitable for drilling through holes in wood, plasterboard and metal channel.
 Manufactured according to DIN 7490 and conforming to the German Employer's Liability Insurance Association in terms of safety requirements for the building trade. The body of the drill bit is attached to the cylindrical shank by means of a thread, therefore eliminating the risk of breakage and guaranteeing absolute concentricity. The small twist angle and enlarged flutes ensure rapid and clog-free chip removal.
 Made in Germany.

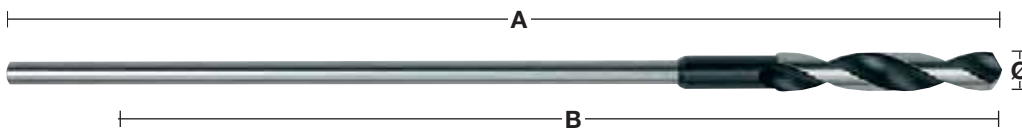

Diameter (mm)	Total length (mm) A	Working length (mm) B	Shank reception	Pack quantity	Min. order quantity	Article Number	EAN Code
6	400	300	5 mm round shank	1	1	4932399672	4002395363223
6	600	500	5 mm round shank	1	1	4932399675	4002395363254
8	400	300	6 mm round shank	1	1	4932363667	4002395331932
8	600	500	6 mm round shank	1	1	4932363674	4002395331864
10	400	300	8 mm round shank	1	1	4932363668	4002395331949
10	600	500	8 mm round shank	1	1	4932363675	4002395331871
12	400	300	8 mm round shank	1	1	4932363669	4002395331956
12	600	500	8 mm round shank	1	1	4932363676	4002395331888
14	400	300	8 mm round shank	1	1	4932363670	4002395331963
14	600	500	8 mm round shank	1	1	4932363677	4002395331895
16	400	300	10 mm round shank	1	1	4932363671	4002395331970
16	600	500	10 mm round shank	1	1	4932363678	4002395331901
18	400	300	10 mm round shank	1	1	4932363672	4002395331987
18	600	500	10 mm round shank	1	1	4932363679	4002395331918
20	400	300	10 mm round shank	1	1	4932363673	4002395331994
20	600	500	10 mm round shank	1	1	4932363680	4002395331925
22	400	300	10 mm round shank	1	1	4932399673	4002395363230
22	600	500	10 mm round shank	1	1	4932399676	4002395363261

BIG HAWG[™]

- Fast cutting: aggressive tooth geometry for greater cutting speed.
- Long life: cuts up to 600 holes in wood without needing to be resharpened.
- Easy plug removal: wide and deep gullets for easy plug removal.
- Super sharp: teeth can be resharpened with diamond file.

Suitability: softwoods, chipboard, medium density fibreboard (MDF), OSB board.



BIG HAWG[™] Hole cutters

Diameter (mm)	Max. cutting depth (mm)	No. of teeth	Pack quantity	Min. order quantity	Article Number	EAN Code
35	60	3	1	1	49568995	045242225378
54	60	3	1	1	49569000	045242200467
57	60	3	1	1	49569005	045242200474
65	60	3	1	1	49569010	045242200481
76	60	3	1	1	49569020	045242200504
86	60	3	1	1	49569025	045242225385
92	60	3	1	1	49569030	045242200511
108	60	3	1	1	49569045	045242200535
110	60	3	1	1	49569047	045242225392
117	60	3	1	1	49569050	045242200542
133	60	3	1	1	49569055	045242225408
159	60	3	1	1	49569065	045242200559



BIG HAWG[™] Hole cutter 7 pc set

Description	Pack quantity	Min. order quantity	Article Number	EAN Code
7 pc BIG HAWG [™] set	7	1	49569075	045242200566
BIG HAWG [™] hole cutter: 54, 65, 92 mm. Arbor with pilot drill, 2x additional pilot drills, diamond file, allen key.				



BIG HAWG[™] System accessories

Description	Reception	Length (mm)	Pack quantity	Min. order quantity	Article Number	EAN Code
① Arbor supplied with pilot flat drill bit.	11 mm Hex	75	1	1	49569105	045242200573
Centre pilot flat drill bit 3/16"		110	1	1	48271401	045242121397
② Diamond file for resharpening teeth.			1	1	48095055	045242089369

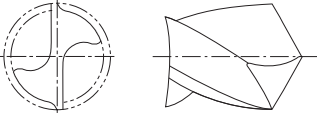
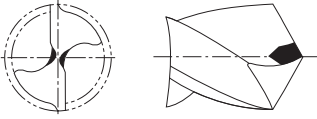
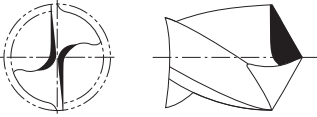
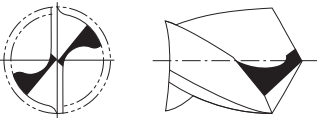
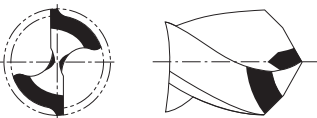
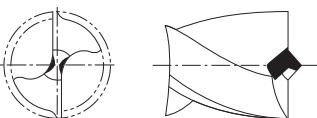
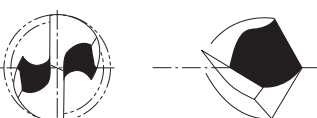

HSS Drill bit tip geometry

		Standard/Form	Application	Features
		Normal Standard Point	For standard drilling in ferrous/non ferrous metals and plastics	The wide cutting edge provides a drill bit that is robust and resistant to sideways pressure. Due to the wide cutting edge higher feed pressure is required. Can be easily resharpened.
		Chisel Edge Point DIN 1412 A	For drilling work in solid steel with large diameter drill bits.	Good and easy centering. Requires very low feed pressure – approx. 30% less than a normal point drill bit.
		Chisel Edge Point with corrected cutting edge DIN 1412 B	For drilling in high strength steel and high alloy steels. Also suitable for drilling thin sheet material.	Robust and resistant to sideways pressure.
		Split Point DIN 1412 C	For drilling in high strength steel and high alloy steels. Suitable for deep drilling bits.	Excellent chip removal makes this design ideal for deep drilling applications. Good centering. Low feed pressure required.
		Double Angle Point for Cast Iron DIN 1412 D	For drilling cast iron.	Extended major cutting edges reduce wear on the cutting corners for improved lifetime. Good heat conduction. Resistant to sideways pressure.
		Centre Point DIN 1412 E	For drilling thin sheet metal and soft materials.	Easy centering. Low feed pressure required. Does not snatch when drilling thin materials. Accurate and clean holes.
		U Point	For high performance drilling in high strength steels such as stainless and acid resistant steel.	Easy centering. Produces small metal chips ensuring low heat build up and quicker material resulting in faster drilling.

HSS Drill bit application guide



The following table gives recommended drilling speeds for the most efficient cutting speed. The tables should only be used as a guide and are dependant on the user and material being drilled. Coolants and lubricants will improve tool life by up to 5 times and workpiece finish.

Material class		Material type	Hardness/ Tensile Strength N/mm ²	Rockwell	Hole diameter Ø mm – RPM					Cooling agent
					Ø 1–2	Ø 3–5	Ø 6–10	Ø 11–15	Ø 16–20	
Steel	Speed	Non-alloyed construction steel, non-alloyed case hardened steel	< 400	< HRB 69	4770	1870	930	630	470	Drilling emulsion, cutting oil
			400–800	< HRC 21	4450	1770	870	580	430	
		Sheet Steel	< 800	< HRC 21	4450	1760	860	560	430	Drilling emulsion, ester oil
		Non-alloyed tool steel	< 800	< HRC 21	4440	1760	860	560	430	Drilling emulsion, cutting oil
		Alloyed tool steel	< 800	< HRC 21	3950	1550	780	520	390	Drilling emulsion, ester oil
			> 800	> HRC 21	1950	800	390	275	200	
	Alloyed hardened & tempered steel	< 1200	< HRC 37	2100	890	450	300	210	Drilling emulsion, ester oil	
> 1200		> HRC 38	1350	540	260	170	120			
Feed	Feed (mm/rev)				0.03	0.09	0.15	0.20	0.25	
Stainless steel	Speed	Stainless steel	< 1000	< HRC 30	2250	930	450	290	220	Rapeseed oil, cutting oil
		Stainless steel	1000–1200	HRC 30–37	1430	560	280	190	130	
	Feed	Feed (mm/rev)				0.02	0.06	0.13	0.18	0.24
Cast iron	Speed	Malleable cast iron	750	HRB 99	4700	2000	1100	800	600	Dry
		Soft	450	HRB 75	4500	1700	950	650	550	Drilling emulsion, cutting oil
		Hard	700	HRB 96	3450	1350	680	440	340	
	Feed	Feed (mm/rev)				0.05	0.10	0.16	0.20	0.25
Aluminium	Speed		< 350	< HRC 59	8700	3560	1720	1130	860	Drilling emulsion, cutting oil
	Feed	Feed (mm/rev)				0.02	0.08	0.13	0.18	0.23
Copper	Speed				5100	2000	990	670	500	Drilling emulsion, cutting oil
	Feed	Feed (mm/rev)				0.02	0.10	0.20	0.28	0.35
Bronze	Speed				7950	3190	1480	1010	770	Dry
	Feed	Feed (mm/rev)				0.02	0.11	0.21	0.32	0.35
Brass	Speed				7950	3190	1480	1010	770	Drilling emulsion
	Feed	Feed (mm/rev)				0.02	0.11	0.21	0.32	0.35
Magnesium	Speed				9550	3800	1900	1250	970	Dry
	Feed	Feed (mm/rev)				0.05	0.10	0.25	0.30	0.35
Plastics	Speed	PVC, Polyamide, Thermoplastics			3500	2500	1800	700	450	Water
	Feed	Feed (mm/rev)				0.05	0.10	0.16	0.21	0.23

RPM: The number of revolutions that a spindle/a cutting tool completes in one minute.

Feed: This is the linear distance at which the cutter is advanced against the workpiece during one rotation of the cutting tool. It is expressed in units of distance per revolution – millimetres per revolution.

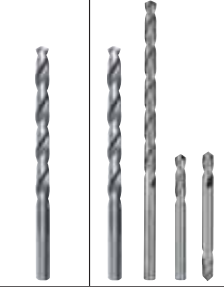
HSS Drill bit application guide

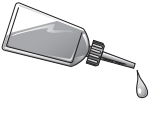
									
Material class	Material type	Hardness/ Tensile Strength N/mm ²	Rockwell	HSS-R DIN 338	HSS-G Thunderweb DIN 338 DIN 340 DIN 1897 Double Ended	RED COBALT - HSS-Ground - DIN 338 RED HEX - Shockwave HSS- Ground Titanium	Step drills	Cooling agent	
Steel	Non-alloyed construction steel, non-alloyed case hardened steel	< 400	< HRB 69		●	●	●	Drilling emulsion, cutting oil	
		400–800	< HRC 21	●	●	●	●		
	Sheet Steel	< 800	< HRC 21		●	●	●	Drilling emulsion, ester oil	
	Non-alloyed tool steel	< 800	< HRC 21	●	●	●	●	Drilling emulsion, cutting oil	
	Alloyed tool steel	< 800	< HRC 21			●	●	●	Drilling emulsion, ester oil
		> 800	> HRC 21			●	●	▲	
Alloyed hardened & tempered steel	< 1200	< HRC 37				●	▲	Drilling emulsion, ester oil	
	> 1200	> HRC 38				●	▲		
Stainless steel	Stainless steel	< 1000	< HRC 30		▲	●	▲	Rapeseed oil, cutting oil	
	Stainless steel	1000–1200	HRC 30–37			●	▲		
Cast iron	Malleable cast iron	750	HRB 99	●	●	●	●	Dry	
	Soft	450	HRB 75	●	●	●	●	Drilling emulsion, cutting oil	
	Hard	700	HRB 96	●	●	●	●		
Aluminium		< 350	< HRC 59		▲	●	●	Drilling emulsion, cutting oil	
Copper					▲	●	●	Drilling emulsion, cutting oil	
Bronze				●	●	●	●	Dry	
Brass				●	●	●	●	Drilling emulsion	
Magnesium						●		Dry	
Plastics	PVC, Polyamide, Thermoplastics				●	●	●	Water	
Wood				●	●	●		Dry	

● Most suitable. Recommended for these materials. ▲ Suitable. Recommended for intermittent use in these materials.

Metal drill bits HSS Rollforged - DIN 338 with reduced shank

High speed steel rollforged metal drill bits produced according to DIN 338.

Oxide coating enables quick swarf removal.

Normal point shaped cutting tip with 118° angle.

Type N flute normal angle.

Suitable for drilling in steel, cast iron, alloyed and non-alloyed material up to 800 N/mm².

Colour: black.

Ø 13.5 mm - Ø 16 mm = 10 mm shank / Ø 16.5 mm - Ø 20 mm = 13 mm shank.

Diameter (mm)	Total length (mm) A	Working length (mm) B	Pack quantity	Min. order quantity	Article Number	EAN Code
13.5	160	108	1	1	4932373318	4002395348435
14.0	160	108	1	1	4932373319	4002395348442
14.5	169	108	1	1	4932373320	4002395348459
15.0	169	114	1	1	4932373321	4002395348466
15.5	178	120	1	1	4932373322	4002395348473
16.0	178	120	1	1	4932373323	4002395348480
16.5	184	125	1	1	4932373324	4002395348497
17.0	184	125	1	1	4932373325	4002395349104
17.5	191	130	1	1	4932373326	4002395349111
18.0	191	130	1	1	4932373327	4002395349128
18.5	198	135	1	1	4932373328	4002395349135
19.0	198	135	1	1	4932373329	4002395349142
19.5	205	140	1	1	4932373330	4002395349159
20.0	205	140	1	1	4932373331	4002395349166

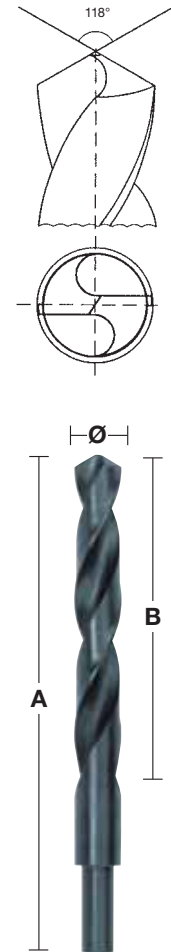

Metal drill bits HSS Rollforged - DIN 338 - cassettes

Description	Supplied in	Pack quantity	Min. order quantity	Article Number	EAN Code
HSS-R drill bit set (19 pcs).					
① Ø 1 / 1.5 / 2 / 2.5 / 3 / 3.5 / 4 / 4.5 / 5 / 5.5 / 6 / 6.5 / 7 / 7.5 / 8 / 8.5 / 9 / 9.5 / 10 mm.	Metal case	19	1	4932352468	4002395371273
HSS-R drill bit set (25 pcs).					
② Ø 1 / 1.5 / 2 / 2.5 / 3 / 3.5 / 4 / 4.5 / 5 / 5.5 / 6 / 6.5 / 7 / 7.5 / 8 / 8.5 / 9 / 9.5 / 10 / 10.5 / 11 / 11.5 / 12 / 12.5 / 13 mm.	Metal case	25	1	4932352469	4002395371280

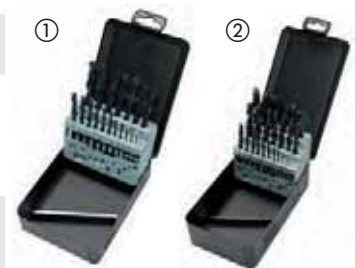

Metal drill bits HSS Rollforged - DIN 338 - 5 and 10 pack

High speed steel rollforged metal drill bits produced according to DIN 338. Oxide coating enables quick swarf removal. Normal point shaped cutting tip with 118° angle. Type N flute normal angle. Suitable for drilling in steel, cast iron, alloyed and non-alloyed material up to 800 N/mm². Colour: black.

Diameter (mm)	Total length (mm) A	Working length (mm) B	Pack quantity	Min. order quantity	Article Number	EAN Code
1.0	34	12	10	1	4932363444	4002395329458
1.5	40	18	10	1	4932363449	4002395329502
2.0	49	24	10	1	4932363454	4002395329557
2.5	57	30	10	1	4932363459	4002395329601
3.0	61	33	10	1	4932363464	4002395329656
3.2	65	36	10	1	4932363466	4002395329670
3.5	70	39	10	1	4932363469	4002395329700
4.0	75	43	10	1	4932363474	4002395329755
4.2	75	43	10	1	4932363476	4002395329779
4.5	80	47	10	1	4932363479	4002395329809
4.8	86	52	10	1	4932363482	4002395329830
5.0	86	52	10	1	4932363484	4002395329854
5.5	93	57	10	1	4932363489	4002395329908
6.0	93	57	10	1	4932363494	4002395329953
6.5	101	63	10	1	4932363499	4002395330003
6.8	109	69	10	1	4932363502	4002395330034
7.0	109	69	10	1	4932363504	4002395330058
7.5	109	69	10	1	4932363509	4002395330102
8.0	117	75	10	1	4932363514	4002395330157
8.5	117	75	10	1	4932363519	4002395330201
9.0	125	81	10	1	4932363524	4002395330256
9.5	125	81	10	1	4932363529	4002395330300
10.0	133	87	10	1	4932363534	4002395330355
10.5	133	87	5	1	4932363539	4002395330409
11.0	142	94	5	1	4932363544	4002395330454
11.5	142	94	5	1	4932363549	4002395330508
12.0	151	101	5	1	4932363554	4002395330553
12.5	151	101	5	1	4932363559	4002395330607
13.0	151	101	5	1	4932363564	4002395330652



Metal drill bits HSS Rollforged - DIN 338 - 345 pc cabinet

Diameter (mm)	Total length (mm) A	Working length (mm) B	Pack quantity	Min. order quantity	Article Number	EAN Code
Metal drill bit cabinet with HSS Rollforged metal drill bits (345 pcs).			345	1	4932352674	4002395373321
1.0	34	12	20			
1.5	40	18	20			
2	49	24	20			
2.5	57	30	20			
3	61	33	20			
3.5	70	39	20			
4	75	43	20			
4.5	80	47	20			
5	86	52	20			
5.5	93	57	20			
6	93	57	20			
6.5	101	63	20			
7	109	69	10			
7.5	109	69	10			
8	117	75	20			
8.5	117	75	10			
9	125	81	10			
9.5	125	81	5			
10	133	87	10			
10.5	133	87	5			
11	142	94	5			
11.5	142	94	5			
12	151	101	5			
12.5	151	101	5			
13	151	101	5			



THUNDERWEB

Metal drill bits HSS Ground - DIN 338



THUNDERWEB

The **THUNDERWEB** design is characterised by a conical shaped web which gets thicker towards the back of the drill bit. The web is the internal core of the drill bit.

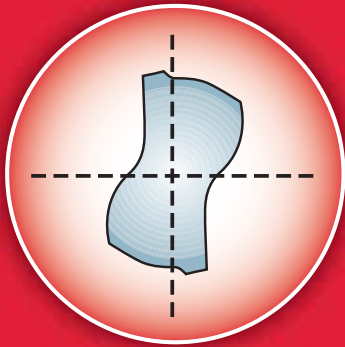

Parabolic web cross section

- Large web thickness. Strength built in.
- Accepts higher feed pressure and torque.
- Less breakages. Good for drilling deep holes and on curved surfaces.
- Long life.



Standard drill bit

The web on standard drill bits is a constant thickness throughout the length of the bit.

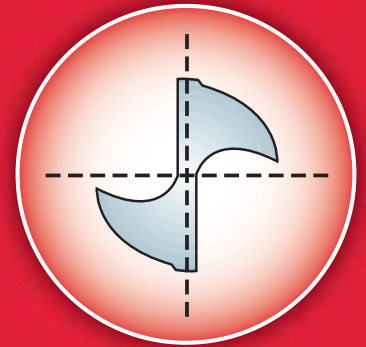

Conventional type web cross section

THUNDERWEB SPECIFICATION

FLUTE GEOMETRY

- **THUNDERWEB** flute form ejects hot chips rapidly. Disseparates heat better increasing lifetime.
- Open flute form reduces drill drawback when drilling deeper holes.
- Sharpened edges reduce binding for faster cleaner cuts.
- Flatter twist angle creates smaller chippings, ideal for drilling harder steels ie. stainless steel.

135° SPLIT POINT

- Precision starting, drill bit won't walk.
- Penetrates quickly.
- Good for drilling on curved surfaces.
- Requires less effort/feed pressure.
- Excellent for very hard materials.



THUNDERWEB - Metal drill bits HSS Ground - DIN 338

Diameter (mm)	Total length (mm) A	Working length (mm) B	Pack quantity	Min. order quantity	Article Number	EAN Code
1.0	34	12	2	1	4932352345	4002395370047
1.5	40	18	2	1	4932352346	4002395370054
2.0	49	24	2	1	4932352347	4002395370061
2.5	57	30	2	1	4932352348	4002395370078
3.0	61	33	2	1	4932352349	4002395370085
3.2	65	36	2	1	4932352350	4002395370092
3.5	70	39	2	1	4932352351	4002395370108
4.0	75	43	2	1	4932352352	4002395370115
4.2	75	43	1	1	4932352353	4002395370122
4.5	80	47	1	1	4932352354	4002395370139
4.8	86	52	1	1	4932352355	4002395370146
5.0	86	52	1	1	4932352356	4002395370153
5.5	93	57	1	1	4932352357	4002395370160
6.0	93	57	1	1	4932352358	4002395370177
6.5	101	63	1	1	4932352359	4002395370184
6.8	109	69	1	1	4932352360	4002395370191
7.0	109	69	1	1	4932352361	4002395370207
7.5	109	69	1	1	4932352362	4002395370214
8.0	117	75	1	1	4932352363	4002395370221
8.5	117	75	1	1	4932352364	4002395370238
9.0	125	81	1	1	4932352365	4002395370245
9.5	125	81	1	1	4932352366	4002395370252
10.0	133	87	1	1	4932352367	4002395370269
10.5	133	87	1	1	4932352368	4002395370276
11.0	142	94	1	1	4932352369	4002395370283
11.5	142	94	1	1	4932352370	4002395370290
12.0	151	101	1	1	4932352371	4002395370306
12.5	151	101	1	1	4932352372	4002395370313
13.0	151	101	1	1	4932352373	4002395370320

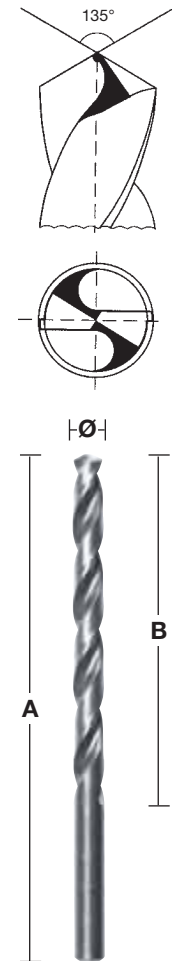

THUNDERWEB - DIN 338 - 5 and 10 pack

NEW

Diameter (mm)	Total length (mm)	Working length (mm)	Pack quantity	Min. order quantity	Article Number	EAN Code
1	34	12	10	1	4932352377	4002395370368
1.1	36	14	10	1	4932459826	4058546029982
1.2	38	16	10	1	4932459827	4058546029999
1.3	38	16	10	1	4932459828	4058546030001
1.4	40	18	10	1	4932459829	4058546030018
1.5	40	18	10	1	4932352378	4002395370375
1.6	43	20	10	1	4932459830	4058546030025
1.7	43	20	10	1	4932459831	4058546030032
1.8	46	22	10	1	4932459832	4058546030049
1.9	46	22	10	1	4932459833	4058546030056
2	49	24	10	1	4932352379	4002395370382
2.1	49	24	10	1	4932459834	4058546030063
2.2	53	27	10	1	4932459835	4058546030070
2.3	53	27	10	1	4932459836	4058546030087
2.4	57	30	10	1	4932430569	4002395382309
2.5	57	30	10	1	4932352380	4002395370399
2.6	57	30	10	1	4932459837	4058546030094
2.7	61	33	10	1	4932459838	4058546030100
2.8	61	33	10	1	4932459839	4058546030117
2.9	61	33	10	1	4932459840	4058546030124
3	61	33	10	1	4932352381	4002395370405
3.1	65	36	10	1	4932459841	4058546030131
3.2	65	36	10	1	4932352382	4002395370412
3.3	65	36	10	1	4932459842	4058546030148
3.4	70	39	10	1	4932459843	4058546030155



THUNDERWEB - DIN 338 - 5 and 10 pack

NEW



Diameter (mm)	Total length (mm)	Working length (mm)	Pack quantity	Min. order quantity	Article Number	EAN Code
3.5	70	39	10	1	4932352383	4002395370429
3.6	70	39	10	1	4932459844	4058546030162
3.7	70	39	10	1	4932459845	4058546030179
3.8	75	43	10	1	4932430547	4002395382088
3.9	75	43	10	1	4932459846	4058546030186
4	75	43	10	1	4932352384	4002395370436
4.1	75	43	10	1	4932459847	4058546030193
4.2	75	43	10	1	4932352385	4002395370443
4.3	80	47	10	1	4932459848	4058546030209
4.4	80	47	10	1	4932459849	4058546030216
4.5	80	47	10	1	4932352386	4002395370450
4.6	80	47	10	1	4932459850	4058546030223
4.7	80	47	10	1	4932459851	4058546030230
4.8	86	52	10	1	4932352387	4002395370467
4.9	86	52	10	1	4932459852	4058546030247
5	86	52	10	1	4932352388	4002395370474
5.1	86	52	10	1	4932459853	4058546030254
5.2	86	52	10	1	4932430548	4002395382095
5.3	86	52	10	1	4932459854	4058546030261
5.4	93	57	10	1	4932459855	4058546030278
5.5	93	57	10	1	4932352389	4002395370481
5.6	93	57	10	1	4932430570	4002395382316
5.7	93	57	10	1	4932459856	4058546030285
5.8	93	57	10	1	4932430549	4002395382101
5.9	93	57	10	1	4932459857	4058546030292
6	93	57	10	1	4932352390	4002395370498
6.1	101	63	10	1	4932459858	4058546030308
6.2	101	63	10	1	4932430550	4002395382118
6.3	101	63	10	1	4932459859	4058546030315
6.4	101	63	10	1	4932430571	4002395382323
6.5	101	63	10	1	4932352391	4002395370504
6.6	101	63	5	1	4932459860	4058546030322
6.7	101	63	5	1	4932459861	4058546030339
6.8	109	69	5	1	4932352392	4002395370511
6.9	109	69	5	1	4932459862	4058546030346
7	109	69	5	1	4932352393	4002395370528
7.1	109	69	5	1	4932459863	4058546030353
7.2	109	69	5	1	4932430551	4002395382125
7.3	109	69	5	1	4932459864	4058546030360
7.4	109	69	5	1	4932459865	4058546030377
7.5	109	69	5	1	4932352394	4002395370535
7.6	117	75	5	1	4932459866	4058546030384
7.7	117	75	5	1	4932459867	4058546030391
7.8	117	75	5	1	4932459868	4058546030407
7.9	117	75	5	1	4932459869	4058546030414
8	117	75	5	1	4932352395	4002395370542
8.1	117	75	5	1	4932459870	4058546030421
8.2	117	75	5	1	4932430552	4002395382132
8.3	117	75	5	1	4932459871	4058546030438
8.4	117	75	5	1	4932430553	4002395382149
8.5	117	75	5	1	4932352396	4002395370559
8.6	125	81	5	1	4932459872	4058546030445
8.7	125	81	5	1	4932459873	4058546030452
8.8	125	81	5	1	4932459874	4058546030469
8.9	125	81	5	1	4932459875	4058546030476
9	125	81	5	1	4932352397	4002395370566
9.1	125	81	5	1	4932459876	4058546030483
9.2	125	81	5	1	4932459877	4058546030490
9.3	125	81	5	1	4932459878	4058546030506
9.4	125	81	5	1	4932459879	4058546030513
9.5	125	81	5	1	4932352398	4002395370573
9.6	133	87	5	1	4932459880	4058546030520
9.7	133	87	5	1	4932459881	4058546030537
9.8	133	87	5	1	4932459882	4058546030544
9.9	133	87	5	1	4932459883	4058546030551

THUNDERWEB - DIN 338 - 5 and 10 pack

NEW

Diameter (mm)	Total length (mm)	Working length (mm)	Pack quantity	Min. order quantity	Article Number	EAN Code
10	133	87	5	1	4932352399	4002395370580
10.5	133	87	5	1	4932352400	4002395370597
11	142	94	5	1	4932352401	4002395370603
11.5	142	94	5	1	4932352402	4002395370610
12	151	101	5	1	4932352403	4002395370627
12.5	151	101	5	1	4932352404	4002395370634
13	151	101	5	1	4932352405	4002395370641



Metal drill bits THUNDERWEB - DIN 338 cassettes

Description	Supplied in	Pack quantity	Min. order quantity	Article Number	EAN Code
THUNDERWEB HSS-G Set (19 pcs).					
① Ø 1 / 1.5 / 2 / 2.5 / 3 / 3.5 / 4 / 4.5 / 5 / 5.5 / 6 / 6.5 / 7 / 7.5 / 8 / 8.5 / 9 / 9.5 / 10 mm.	Plastic cassette	19	1	4932352374	4002395370337
② Counter display with 6 x 19 pc HSS-G drill set 4932352374.	-	6	1	4932352375	4002395370344
THUNDERWEB HSS-G Set (25 pcs).					
③ Ø 1 / 1.5 / 2 / 2.5 / 3 / 3.5 / 4 / 4.5 / 5 / 5.5 / 6 / 6.5 / 7 / 7.5 / 8 / 8.5 / 9 / 9.5 / 10 / 10.5 / 11 / 11.5 / 12 / 12.5 / 13 mm.	Plastic cassette	25	1	4932352376	4002395370351



RED HEX - Shockwave HSS-Ground Titanium Metal drill bits

- Impact rated drill bit with 1/4" hex shank optimised for impact drivers.
- The 135° tip angle reduces tip walking and allows a precise start.
- The flute design allows for a faster material ejection and decreases heat build up for more efficiency.
- The titanium coating dispenses heat.
- Higher versatility thanks to the 1/4" hex shank which makes this drill bit suitable for impact and drill drivers.

RED HEX

Diameter (mm)	Total length (mm) A	Working length (mm) B	Pack quantity	Min. order quantity	Article Number	EAN Code
2	59.5	17	2	1	48894703	045242501557
2.5	62	19	2	1	48894704	045242501564
3	65	23	2	1	48894763	045242506866
3.2	66.5	23	2	1	48894706	045242501571
3.5	69	25	2	1	48894707	045242501588
4	71.5	26	2	1	48894708	045242501595
4.2	74	28	1	1	48894709	045242501601
4.5	76	29	1	1	48894710	045242501618
4.8	78	29	1	1	48894711	045242501625
5	93	46	1	1	48894712	045242501632
5.5	104	59	1	1	48894764	045242506873
6	105	60	1	1	48894714	045242501649
6.5	107	63	1	1	48894715	045242501656
6.8	108	64	1	1	48894716	045242501663
7	109	65	1	1	48894717	045242501670
7.5	110	66	1	1	48894718	045242501687
8	111	67	1	1	48894719	045242501694
8.5	114	70	1	1	48894720	045242501700
9	117	73	1	1	48894721	045242501717
9.5	118	74	1	1	48894722	045242501724
10	120	76	1	1	48894723	045242501731
10.5	122	78	1	1	48894724	045242501748
11	125	81	1	1	48894725	045242501755
11.5	126	82	1	1	48894726	045242501762
12	127	83	1	1	48894727	045242501779
12.5	128	83	1	1	48894728	045242501786
13	130	85	1	1	48894729	045242501793
Shockwave HSS-G TiN Red Hex drill bit set in plastic cassette (10 pcs)						
①			10	1	48894759	045242502066
Ø 3 / 3.5 / 4 / 4.5 / 5 / 6 / 7 / 8 / 9 / 10 mm.						
Shockwave HSS-G TiN Red Hex drill bit set in plastic cassette (19 pcs)						
②			19	1	48894760	045242502073
Ø 2 / 2.5 / 2 x 3 / 3.5 / 2 x 4 / 4.5 / 5.5 / 6 / 6.5 / 7 / 7.5 / 8 / 8.5 / 9 / 9.5 / 10 mm.						

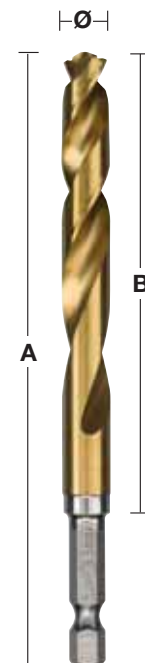

135° SPLIT POINT™

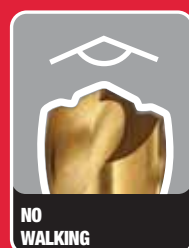

FOR IMPACTS & DRILLS



Metal drill bits HSS Ground Long - DIN 340 / 5 and 10 pack

High quality high speed steel. Split point DIN 1412 C.
 Right hand cutting edge. 135° angle for improved centering.
 Most suitable for drilling deep holes in channels or where there are hollow sections.
 Suitable for drilling steel, cast iron, alloyed and non alloyed material up to 900 N/mm².
 Also suitable for wood and plastics.

Diameter (mm)	Total length (mm) A	Working length (mm) B	Pack quantity	Min. order quantity	Article Number	EAN Code
2.0	85	56	10	1	4932430328	4002395379897
2.5	95	62	10	1	4932430329	4002395379903
3.0	100	66	10	1	4932430330	4002395379910
3.5	112	73	10	1	4932430331	4002395379927
4.0	119	78	10	1	4932430332	4002395379934
4.5	126	82	10	1	4932430333	4002395379941
5.0	132	87	10	1	4932430334	4002395379958
5.5	139	91	10	1	4932430335	4002395379965
6.0	139	91	10	1	4932430336	4002395379972
6.5	148	97	10	1	4932430337	4002395379989
7.0	156	102	10	1	4932430338	4002395379996
8.0	165	109	10	1	4932430339	4002395380008
9.0	175	115	10	1	4932430340	4002395380015
10.0	184	121	10	1	4932430341	4002395380022
11.0	195	128	5	1	4932430342	4002395380039
12.0	205	134	5	1	4932430343	4002395380046
13.0	205	134	5	1	4932430344	4002395380053

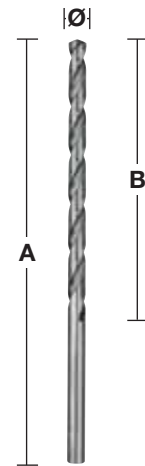
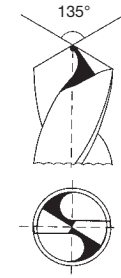

Metal drill bits HSS Ground Short - DIN 1897 - 5 and 10 pack

Drill bit quality: High quality high speed steel. Tip geometry: Split Point DIN 1412 C. Point angle: 118°. Tolerance: h8. Flute / Helix angle: Type N flute and normal 20 - 30° angle. Right hand cutting edge. Surface / Colour: Polished silver. Withstands high drill point pressure due to short overall length. Excellent concentricity. Polished type N flute with right hand cutting edge, eliminates binding for faster chip removal and faster cutting with less effort.
Application: Most suited for drilling sheet and thin walled materials.
Suitable for drilling in sheet steel, thin alloyed and non-alloyed material up to 900 N/mm². Also suitable for wood and plastics.

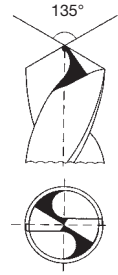

Diameter (mm)	Total length (mm) A	Working length (mm) B	Pack quantity	Min. order quantity	Article Number	EAN Code
2.0	38	12	10	1	4932352200	4002395368532
2.5	43	14	10	1	4932352201	4002395368549
3.0	46	16	10	1	4932352202	4002395368556
3.2	49	18	10	1	4932352203	4002395368563
3.3	49	18	10	1	4932352204	4002395368570
3.5	52	20	10	1	4932352205	4002395368587
3.7	52	20	10	1	4932352206	4002395368594
4.0	55	22	10	1	4932352207	4002395368600
4.2	55	22	10	1	4932352208	4002395368617
4.5	58	24	10	1	4932352209	4002395368624
4.8	62	26	10	1	4932352210	4002395368631
5.0	62	26	10	1	4932352211	4002395368648
5.2	62	26	10	1	4932352212	4002395368655
5.5	66	28	10	1	4932352213	4002395368662
6.0	66	28	10	1	4932352214	4002395368679
6.5	70	31	10	1	4932352215	4002395368686
7.0	74	34	10	1	4932352216	4002395368693
7.5	74	34	5	1	4932352217	4002395368709
8.0	79	37	5	1	4932352218	4002395368716
8.5	79	37	5	1	4932352219	4002395368723
9.0	84	40	5	1	4932352220	4002395368730
10.0	89	43	5	1	4932352221	4002395368747

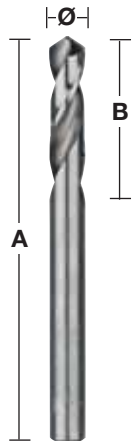

Metal drill bits HSS Ground - Double ended

Drill bit quality: High quality high speed steel. Tip geometry: Split Point DIN 1412 C. Point angle: 135°. Tolerance: h8. Flute / Helix angle: Type N flute and normal 20 - 30° angle. Right hand cutting edge. Surface / Colour: Polished silver. Split point tip for good centering. Both ends can be used. Due to its short length it can be used with higher feed pressure without the risk of breakage. Excellent concentricity. Polished type N flute with right hand cutting edge, eliminates binding for faster chip removal and faster cutting with less effort.
Application: Suitable drilling in steel, non-ferrous metals and plastic. Most suitable for thin sheet materials, e.g. rivet holes.

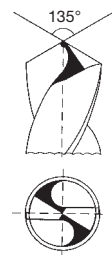

Diameter (mm)	Total length (mm) A	Working length (mm) B	Pack quantity	Min. order quantity	Article Number	EAN Code
2.5	43	10	10	1	4932352222	4002395368754
3.0	46	11	10	1	4932352223	4002395368761
3.2	49	12	10	1	4932352224	4002395368778
3.3	49	12	10	1	4932352225	4002395368785
3.5	52	14	10	1	4932352226	4002395368792
4.0	55	14	10	1	4932352227	4002395368808
4.1	55	14	10	1	4932352228	4002395368815
4.2	55	14	10	1	4932352229	4002395368822
4.5	58	16	10	1	4932352230	4002395368839
4.8	62	18	10	1	4932352231	4002395368846
5.0	62	18	10	1	4932352232	4002395368853
5.5	66	19	10	1	4932352233	4002395368860
6.0	66	19	10	1	4932352234	4002395368877

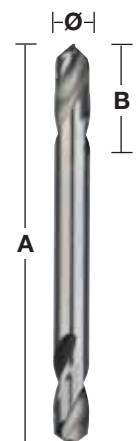

RED COBALT - HSS-Ground - DIN 338 Metal drill bits

NEW

Metal drill bits ground from solid extremely heat resistant cobalt-alloyed high speed steel produced according to DIN 338.

Split point shaped cutting tip with 135° angle for improved centering - no center punch required.

5% Cobalt content. Withstands high drilling heat.

Type N flute normal angle.

Suitable for drilling high alloy content steels and metals with tensile strengths over 1000 N/mm² like heat and acid proof steels and stainless steel.

3-flat shank from 5 mm diameter for better grip and prevents chuck slippage.

Colour: bronze.

**RED
COBALT**

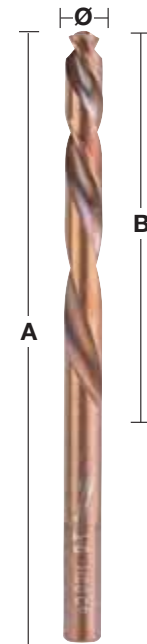
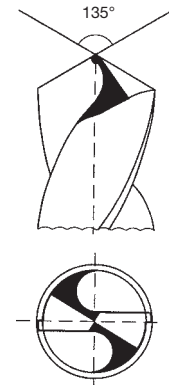

Diameter (mm)	Total length (mm) A	Working length (mm) B	Pack quantity	Min. order quantity	Article Number	EAN Code
1.0	34	12	2	1	4932363248	4002395333080
1.5	40	18	2	1	4932363249	4002395333097
2.0	49	24	2	1	4932363250	4002395333103
2.5	57	30	2	1	4932363251	4002395333110
3.0	61	33	2	1	4932363253	4002395333134
3.2	65	36	2	1	4932363254	4002395333141
3.5	70	39	2	1	4932363256	4002395333165
4.0	75	43	2	1	4932363258	4002395333189
4.2	75	43	1	1	4932363260	4002395333202
4.5	80	47	1	1	4932363262	4002395333226
4.8	86	52	1	1	4932363263	4002395333233
5.0	86	52	1	1	4932363264	4002395333240
5.5	93	57	1	1	4932363267	4002395333271
6.0	93	57	1	1	4932363268	4002395333288
6.5	101	63	1	1	4932363269	4002395333295
6.8	109	69	1	1	4932363270	4002395333301
7.0	109	69	1	1	4932363271	4002395333318
7.5	109	69	1	1	4932363272	4002395333325
8.0	117	75	1	1	4932363274	4002395333349
8.5	117	75	1	1	4932363276	4002395333363
9.0	125	81	1	1	4932363277	4002395333370
9.5	125	81	1	1	4932363278	4002395333387
10.0	133	87	1	1	4932363279	4002395333394
10.5	133	87	1	1	4932363281	4002395333417
11.0	142	94	1	1	4932363282	4002395333424
11.5	142	94	1	1	4932363283	4002395333431
12.0	151	101	1	1	4932363284	4002395333448
12.5	151	101	1	1	4932363285	4002395333455
13.0	151	101	1	1	4932363286	4002395333462

RED COBALT - HSS-Ground - DIN 338 Metal drill bits - cassettes

NEW

Description	Supplied in	Pack quantity	Min. order quantity	Article Number	EAN Code
RED COBALT - HSS Ground - DIN 338 set (19 pcs).					
① Ø 1 / 1.5 / 2 / 2.5 / 3 / 3.5 / 4 / 4.5 / 5 / 5.5 / 6 / 6.5 / 7 / 7.5 / 8 / 8.5 / 9 / 9.5 / 10 mm.	Plastic cassette	19	1	4932352470	4002395371297
RED COBALT - HSS Ground - DIN 338 set (25 pcs).					
② Ø 1 / 1.5 / 2 / 2.5 / 3 / 3.5 / 4 / 4.5 / 5 / 5.5 / 6 / 6.5 / 7 / 7.5 / 8 / 8.5 / 9 / 9.5 / 10 / 10.5 / 11 / 11.5 / 12 / 12.5 / 13 mm.	Plastic cassette	25	1	4932352471	4002395371303



RED COBALT - HSS-Ground - DIN 338 Metal drill bits - 5 and 10 pack

NEW

Metal drill bits ground from solid extremely heat resistant cobalt-alloyed high speed steel produced according to DIN 338.

Polished finish. Split point shaped cutting tip with 135° angle for improved centering - no center punch required.

5% Cobalt content withstands high drilling heat.

Type N flute normal angle.

Suitable for drilling high alloy content steels and metals with tensile strengths over 1000 N/mm² like heat and acid proof steels and stainless steel.

3-flat shank from 5 mm diameter for better grip and prevents chuck slippage.

Colour: bronze.

**RED
COBALT**

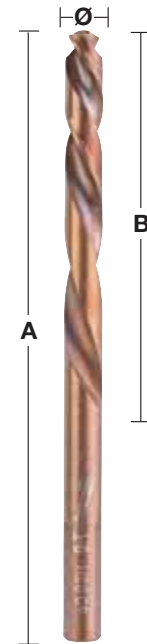
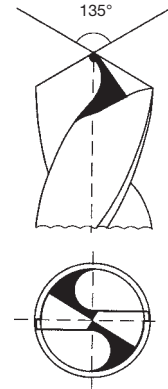

Diameter (mm)	Total length (mm) A	Working length (mm) B	Pack quantity	Min. order quantity	Article Number	EAN Code
1.0	34	12	10	1	4932373332	4002395349173
1.5	40	18	10	1	4932373333	4002395349180
2.0	49	24	10	1	4932373334	4002395349197
2.5	57	30	10	1	4932373335	4002395349807
3.0	61	33	10	1	4932373336	4002395349814
3.2	65	36	10	1	4932373337	4002395349821
3.5	70	39	10	1	4932373338	4002395349838
4.0	75	43	10	1	4932373339	4002395349845
4.2	75	43	10	1	4932373340	4002395349852
4.5	80	47	10	1	4932373341	4002395349869
4.8	86	52	10	1	4932373342	4002395349876
5.0	86	52	10	1	4932373343	4002395349883
5.5	93	57	10	1	4932373344	4002395349890
6.0	93	57	10	1	4932373345	4002395347100
6.5	101	63	10	1	4932373346	4002395347117
6.8	109	69	5	1	4932373347	4002395347124
7.0	109	69	5	1	4932373348	4002395347131
7.5	109	69	5	1	4932373349	4002395347148
8.0	117	75	5	1	4932373350	4002395347155
8.5	117	75	5	1	4932373351	4002395347162
9.0	125	81	5	1	4932373352	4002395347179
9.5	125	81	5	1	4932373353	4002395347186
10.0	133	87	5	1	4932373354	4002395347193
10.5	133	87	5	1	4932373355	4002395347803
11.0	142	94	5	1	4932373356	4002395347810
11.5	142	94	5	1	4932373357	4002395347827
12.0	151	101	5	1	4932373358	4002395347834
12.5	151	101	5	1	4932373359	4002395347841
13.0	151	101	5	1	4932373360	4002395347858

Step drills

- Step Drill advantages over conventional drill bits:
 - One drill bit to drill multiple sizes - Do more carry less!
 - Best option for enlarging existing holes.
 - More durable than twist drill bits, thick core resists breakage.
 - More accurate and less walking, tip starts on contact.
 - Clean burr free holes, less reaming required.
 - Drills plastic without splitting or cracking.

- Step drills are ideal for drilling into the following materials:
 - Ferrous & non-ferrous sheets metals, profiles and pipes.
 - Copper, brass and aluminium.
 - Stainless steel.
 - Plastics.
 - Maximum material thickness 4 mm.
 - To ensure best lifetime we recommend the use of a coolant.

- Trades:
 - Electrical: drilling of panels and cabinets for cable gland installation.
 - Plumbing / HVAC: access holes for pipework and installtion.
 - Metal workers / fabrication: various sizes and hole enlargement.
 - Automotive: holes for cable installation (mobile telephones, antennas, re-directing electrical wiring).
 - Maintenance repair operations: various applications, sizes and hole enlargement.



Milwaukee® Advantages

Spot drill - Drill - Debur - All in one go

- ① Rapid Strike tip for improved centering - less walking and fast drilling without the need to punch or pre drill the material.
- ② Special tip and step geometry for jam-free performance - less risk of drill snagging when used with high speed cordless tools and also prevents deformation of the drilled material.
- ③ Optimised 2 flute ground sharpened edge geometry for 2 x faster and smoother cutting.
- ④ Produced from custom engineered steel with black oxide coating for 4 x longer life. Optimised for use with high speed cordless drills.
- ⑤ Laser engraved size markings for best long term visibility.
- ⑥ Each step is relief ground to drill and deburr automatically.
- ⑦ With 3 flat secure grip to prevent step drill from slipping in the chuck and ensure maximum transmission of torque.



UPTO
2x
FASTER

UPTO
4x
LIFE

UPTO
25%
MORE HOLES
PER CHARGE

Step drills

	Description	Shank diameter (mm)	Overall length (mm)	No. of steps	Pack quantity	Min. order quantity	Article Number	EAN Code
①	PG 7 - PG 21	10	68	9	1	1	48899321	045242364060
②	M 6 - M 32	10	92	13	1	1	48899332	045242344437
③	4 - 12 mm / 1"	6	65	9	1	1	48899301	045242342532
④	4 - 12 mm / 2"	6	65	5	1	1	48899302	045242342549
⑤	4 - 20 mm	8	65	9	1	1	48899320	045242344406
⑥	6 - 35 mm	10	90	14	1	1	48899335	045242344413
⑦	Step drill set (3 pcs) Includes step drills no. 3, 5, 6.				3	1	48899399	045242344420

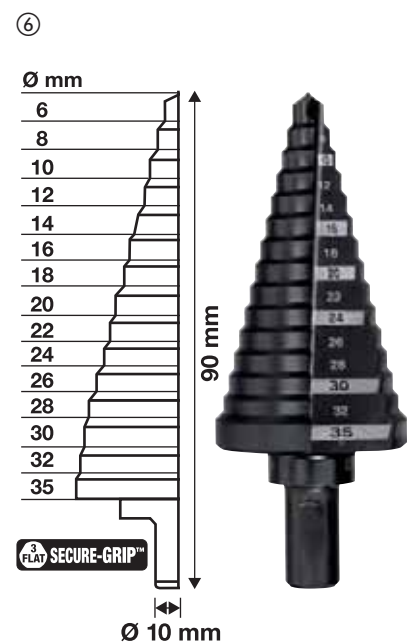
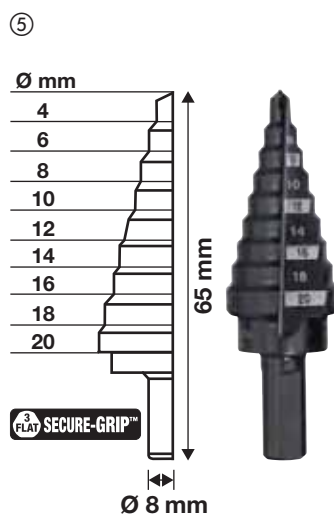
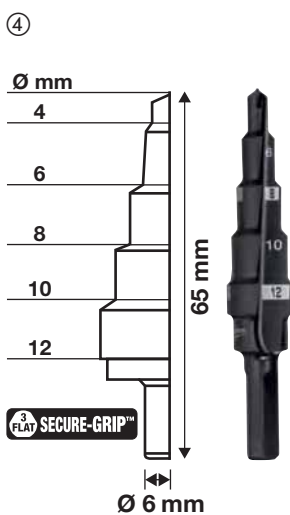
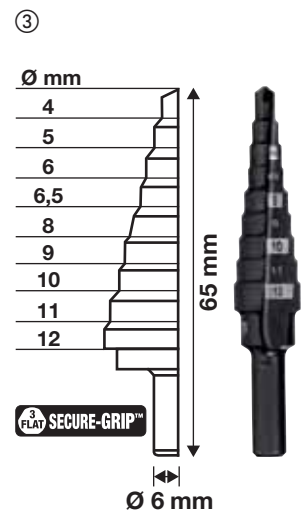
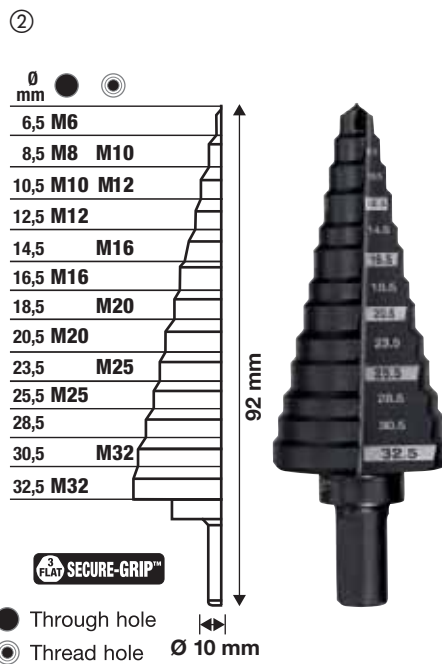

Magnetic Drilling



100% Faster

Speed and time savings are achieved due to the following factors. Firstly the annular cutter principle of only cutting material from the periphery of the hole as opposed to the twist drill which must cut the complete diameter of the hole. Secondly the benefit of two aggressive sharp angles per cutting edge help to achieve faster feed rates and lower cutting resistance.

30% More productivity

Because the annular cutter is only cutting material from the periphery of the hole.

Less motor energy and driving power is required.

The larger the drill diameter the greater the energy saving.

Longer lifetime

The annular cutters cutting edges do less work than the twist drill resulting in more holes between sharpening. Thick 6 mm body together with special tooth geometry ensures high stability and reduces to a minimum the risk of breakage due to overloading.

Speed chart

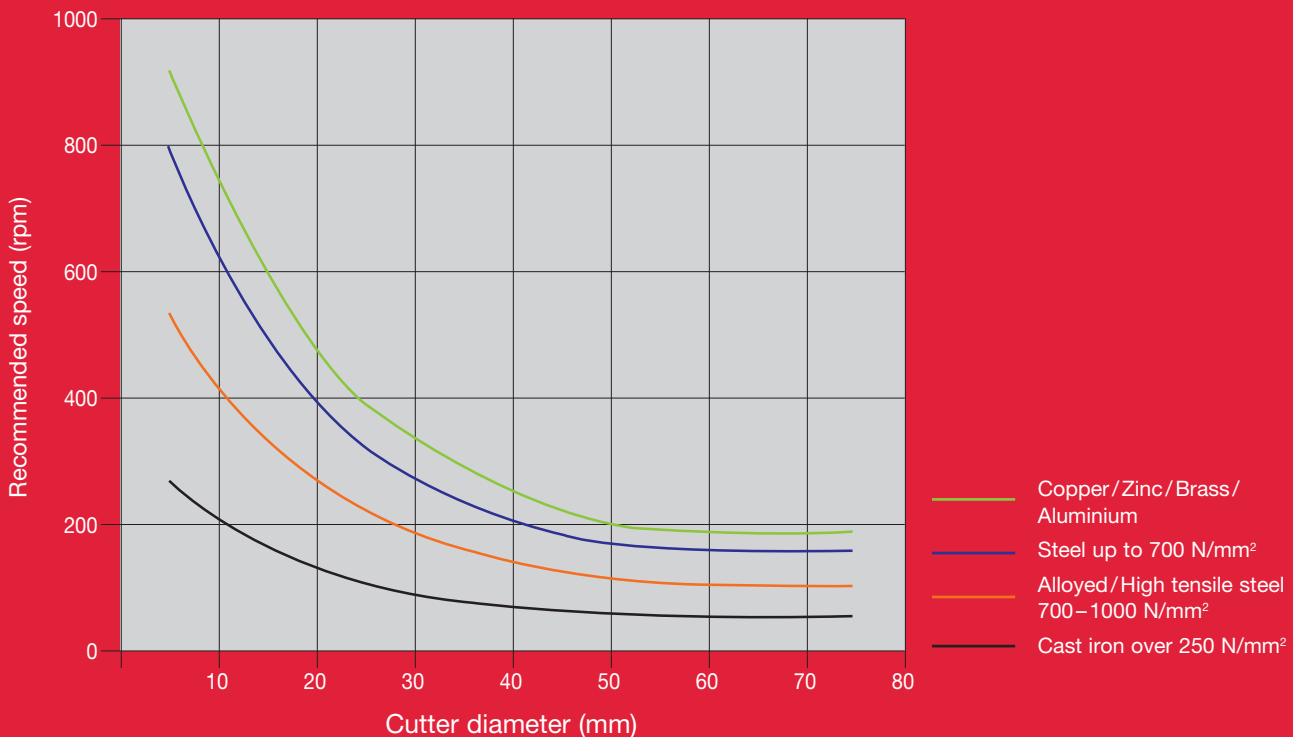

HSS annular cutters

Thick walled HSS annular cutters for increased durability and life time. With standard 19 mm Weldon reception.

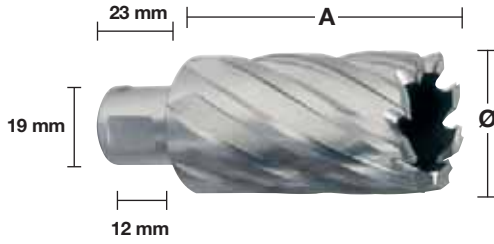

30 mm

Diameter (mm)	Total length (mm) A	Pack quantity	Min. order quantity	Article Number	EAN Code
12	30	1	1	4932371740	4002395344161
13	30	1	1	4932371741	4002395344178
14	30	1	1	4932343270	4002395315130
15	30	1	1	4932343271	4002395315147
16	30	1	1	4932343272	4002395315154
17	30	1	1	4932343273	4002395315161
18	30	1	1	4932343274	4002395315178
19	30	1	1	4932343275	4002395315185
20	30	1	1	4932343276	4002395315192
21	30	1	1	4932343277	4002395315208
22	30	1	1	4932343278	4002395315215
23	30	1	1	4932343279	4002395315222
24	30	1	1	4932343280	4002395315239
25	30	1	1	4932343281	4002395315246
26	30	1	1	4932343282	4002395315253
27	30	1	1	4932343283	4002395315260
28	30	1	1	4932343284	4002395315277
29	30	1	1	4932343285	4002395315284
30	30	1	1	4932343286	4002395315291
31	30	1	1	4932343287	4002395315307
32	30	1	1	4932343288	4002395315314
33	30	1	1	4932371742	4002395344185
34	30	1	1	4932371743	4002395344192
35	30	1	1	4932371744	4002395344208
36	30	1	1	4932371745	4002395344215
37	30	1	1	4932371746	4002395344222
38	30	1	1	4932371747	4002395344239
39	30	1	1	4932371748	4002395344246
40	30	1	1	4932371749	4002395344253
41	30	1	1	4932371750	4002395344260
42	30	1	1	4932371751	4002395344277
43	30	1	1	4932371752	4002395344284
44	30	1	1	4932371753	4002395344291
45	30	1	1	4932371754	4002395344307
46	30	1	1	4932371755	4002395344314
47	30	1	1	4932371756	4002395344321
48	30	1	1	4932371757	4002395344338
49	30	1	1	4932371758	4002395344345
50	30	1	1	4932371759	4002395344352

50 mm

Diameter (mm)	Total length (mm) A	Pack quantity	Min. order quantity	Article Number	EAN Code
14	50	1	1	4932343289	4002395315352
15	50	1	1	4932343290	4002395315369
16	50	1	1	4932343291	4002395315376
17	50	1	1	4932343292	4002395315383
18	50	1	1	4932343293	4002395315390
19	50	1	1	4932343294	4002395315406
20	50	1	1	4932343295	4002395315413
21	50	1	1	4932343296	4002395315420
22	50	1	1	4932343297	4002395315437
23	50	1	1	4932343298	4002395315444
24	50	1	1	4932343299	4002395315451
25	50	1	1	4932343300	4002395315468
26	50	1	1	4932343301	4002395315475
27	50	1	1	4932343302	4002395315482
28	50	1	1	4932343303	4002395315499
29	50	1	1	4932343304	4002395315505
30	50	1	1	4932343305	4002395315512
31	50	1	1	4932343306	4002395315529
32	50	1	1	4932343307	4002395315536
33	50	1	1	4932371760	4002395344369
34	50	1	1	4932371761	4002395344376
35	50	1	1	4932371762	4002395344383
36	50	1	1	4932371763	4002395344390
37	50	1	1	4932371764	4002395344406
38	50	1	1	4932371765	4002395344413
39	50	1	1	4932371766	4002395344420
40	50	1	1	4932371767	4002395344437
41	50	1	1	4932371768	4002395344444
42	50	1	1	4932371769	4002395344451
43	50	1	1	4932371770	4002395344468
44	50	1	1	4932371771	4002395344475
45	50	1	1	4932371772	4002395344482
46	50	1	1	4932371773	4002395344499
47	50	1	1	4932371774	4002395344505
48	50	1	1	4932371775	4002395344512
49	50	1	1	4932371776	4002395344529
50	50	1	1	4932371777	4002395344536

Description	Supplied in	Pack quantity	Min. order quantity	Article Number	EAN Code
Telescopic ejector pin for 30 mm cutters.		2	1	49590011	045242364039
Telescopic ejector pin for 50 mm cutters.		2	1	49590012	045242364046
6 pc HSS annular cutter set 19 mm Weldon reception and ejector pin short series - 30 mm.					
①	Plastic case	6	1	4932372533	4002395345236
Ø 14 / 16 / 18 / 20 / 22 / 24 mm.					

System accessories - Magnetic drill stands

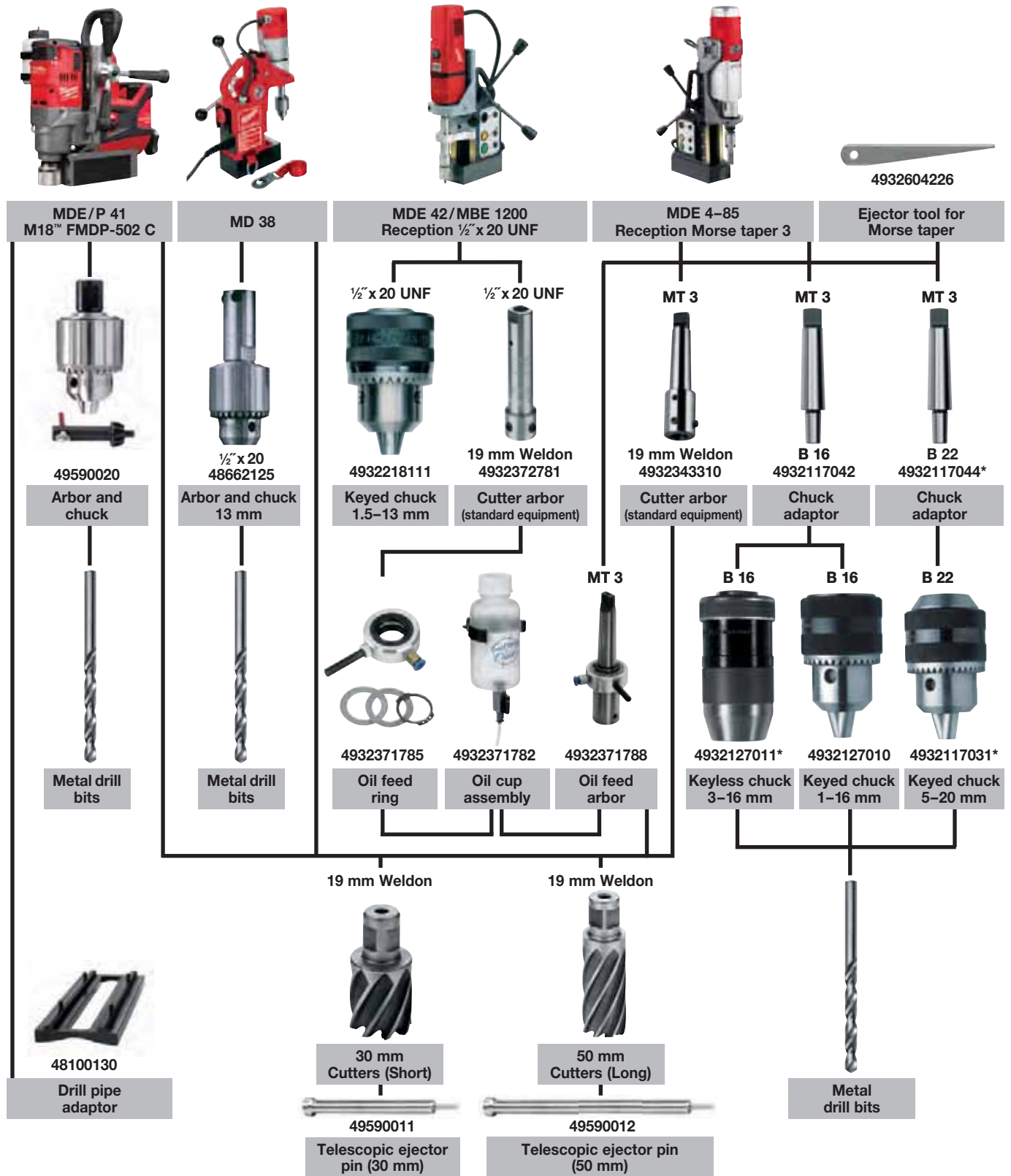

* while stocks last



Nothing but **HEAVY DUTY**.™

High Performance Bi-Metal Holesaws

HOLE DOZER™

The Milwaukee® *Hole Dozer*™ is the jobsite workhorse that provides unstoppable durability through the most demanding applications.



Ø 14-152 mm



Ø 160-210 mm



- Lifetime warranty against tooth breakage
- Rip guard tooth geometry provides for the most durable tooth form and best lifetime

PLUG JACK™

PLUG JACK™



- Multiple leverage points to work cut material out of the holesaw for faster plug removal
 - Deepest access for thick plugs
 - Higher access for thin material
- Minimises downtime between cuts
- New coating allows less friction and increases drilling speed



Tooth design

A variable 4–6 teeth per inch tooth design with a positive 10° tooth angle provides the following benefits:

- Faster and more aggressive cut.
- Improved heat dispersion during cutting ensures that the teeth stay sharper for longer.
- Deeper curved gullets provide more efficient chip clearance preventing clogging and heat build up.
- Special shaped tooth angle has less tendency to snag on thinner materials.
- Teeth are alternate/side set to minimise binding and friction.
- Requires less feed pressure – This is achieved by the combination of aggressive tooth geometry and good chip clearance resulting in the requirement of less force during drilling.

Holesaw body

- 1.27 mm thick steel holesaw body is rigid to retain its shape but also has built in elasticity.
- Effective sawing depth is 41 mm.

Applications

- High quality manufacturing techniques ensure high rotational precision, therefore these holesaws are suitable for use both in hand and pillar drills (manual feed only).
- This high quality holesaw range is the perfect solution for cutting all types of materials:
 - Steel up to 1000 N/mm² strength
 - Stainless steel and acid resistant steel
 - Non-ferrous metals
 - Cast iron
 - Aluminium
 - Wood
 - Medium density fibreboard (MDF)
 - Gypsum plasterboard
 - Sandwich materials
 - PVC

Tooth material

- Type Matrix II premium high speed steel is used for the toothed area of the holesaw. Matrix II steel contains 8% cobalt allowing the teeth to retain the original tooth hardness even at high working temperatures when used in metal cutting applications.
- Bi-Metal construction – High speed steel teeth are laser welded onto a low alloy steel body. The teeth are then vacuum hardened to 65 HRC at a temperature of 600°C to give maximum durability and lifetime.
- Due to the high wear resistance of the Matrix II steel, these holesaws are ideal for cutting difficult and hard materials such as stainless steel and acid resistant steels as well as softer materials like wood.

Back plate design

- The back plates are constructed with thick steel thus the holes will not enlarge over time. Thick backs add strength and rigidity minimising vibrations.
- 4 drive pin holes for easier arbor location.
- Perfectly manufactured round back plate, especially important for the larger diameter holesaws.



FIXTEC arbors

① For holesaws Ø 14–30 mm

FIXTEC “twist release” quick change arbor. Prevents holesaw locking onto the arbor. Compatible to all manufacturers holesaws – no adapter required.

② For holesaws Ø 32–210 mm

The locking nut secures and locks the arbor drive plate against the back of the holesaw for a stable fit, eliminating holesaw wobble and vibration.



①



②

Hole Dozer[™] holesaws - A cut above the rest!

Diameter (mm)	Ø (inch)	Max. cutting depth (mm)	Pack quantity	Min. order quantity	Article Number	EAN Code
14	9/16	41	1	1	49560002	045242271061
16	5/8	41	1	1	49560012	045242192922
17	11/16	41	1	1	49560014	045242193639
19	3/4	41	1	1	49560023	045242192632
20	25/32	41	1	1	49560024	045242271016
21	13/16	41	1	1	49560027	045242192649
22	7/8	41	1	1	49560032	045242192878
24	15/16	41	1	1	49560037	045242192885
25	1	41	1	1	49560043	045242192526
27	1 1/16	41	1	1	49560047	045242192892
29	1 1/8	41	1	1	49560052	045242192939
30	1 3/16	41	1	1	49560057	045242192946
32	1 1/4	41	1	1	49560062	045242192977
33	1 5/16	41	1	1	49560067	045242192984
35	1 3/8	41	1	1	49560072	045242192991
37	1 7/16	41	1	1	49560077	045242193028
38	1 1/2	41	1	1	49560082	045242193035
40	1 9/16	41	1	1	49560087	045242193042
41	1 5/8	41	1	1	49560092	045242193073
43	1 11/16	41	1	1	49560097	045242193080
44	1 3/4	41	1	1	49560102	045242193097
46	1 13/16	41	1	1	49560107	045242193127
48	1 7/8	41	1	1	49560112	045242193134
50	1 31/32	41	1	1	49560113	045242271023
51	2	41	1	1	49560117	045242193141
52	2 1/16	41	1	1	49560122	045242193172
54	2 1/8	41	1	1	49560127	045242193189
56	4/6	41	1	1	49560129	045242504664
57	2 1/4	41	1	1	49560132	045242193196
59	2 5/16	41	1	1	49560137	045242193226
60	2 3/8	41	1	1	49560142	045242193233
64	2 1/2	41	1	1	49560147	045242193240
65	2 9/16	41	1	1	49560153	045242193271
67	2 5/8	41	1	1	49560158	045242193288
68	2 11/16	41	1	1	49560159	045242271030
70	2 3/4	41	1	1	49560163	045242193295
73	2 7/8	41	1	1	49560167	045242193325
76	3	41	1	1	49560173	045242193332
79	3 1/8	41	1	1	49560177	045242193349
83	3 1/4	41	1	1	49560183	045242193370
86	3 3/8	41	1	1	49560187	045242193387
89	3 1/2	41	1	1	49560193	045242193394
92	3 5/8	41	1	1	49560197	045242193431
95	3 3/4	41	1	1	49560203	045242193448
98	3 7/8	41	1	1	49560207	045242193479
102	4	41	1	1	49560213	045242193486
105	4 1/8	41	1	1	49560217	045242193493
111	4 3/8	41	1	1	49560227	045242193530
114	4 1/2	41	1	1	49560233	045242193547
121	4 3/4	41	1	1	49560237	045242193578
127	5	41	1	1	49560243	045242193585
133	5 1/4	41	1	1	49560244	045242271078
140	5 1/2	41	1	1	49560247	045242193592
152	6	41	1	1	49560253	045242193622
160	6 5/16	38	1	1	4932399885	4002395365395
168	6 5/8	38	1	1	4932399886	4002395365401
177	6 31/32	38	1	1	4932399887	4002395365418
200	7 7/8	38	1	1	4932399888	4002395365425
210	8 9/32	38	1	1	4932399889	4002395365432

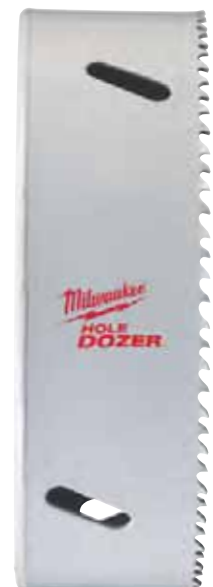

Hole Dozer™ holesaws: Recommended cutting speed in RPM

Diameter (mm)	Ø (inch)	Metal	Cast Iron	Steel	Non ferrous metal	Aluminium	Wood	MDF
14	9/16	580	400	300	790	900	1500	750
16	5/8	550	365	275	730	825	1500	750
17	11/16	500	330	250	665	750	1500	750
19	3/4	460	300	230	600	690	1500	750
20	25/32	425	280	210	560	635	1500	750
21	13/16	425	280	210	560	635	1500	750
22	7/8	390	260	195	520	585	1500	750
23	29/32	370	250	185	500	550	1500	750
25	1	350	235	175	470	525	1500	750
27	1 1/16	325	215	160	435	480	1400	700
29	1 1/8	300	200	150	400	450	1400	700
30	1 3/16	285	190	145	380	425	1400	700
32	1 1/4	275	180	140	380	410	1400	700
33	1 5/16	260	175	135	345	390	1400	700
35	1 3/8	250	165	125	330	375	1400	700
37	1 7/16	240	160	120	315	360	1400	700
38	1 1/2	230	150	115	300	345	1400	700
40	1 9/16	220	145	110	290	330	1200	600
41	1 5/8	210	140	105	280	315	1200	600
43	1 11/16	205	135	100	270	305	1200	600
44	1 3/4	195	130	95	260	295	1200	600
46	1 13/16	190	125	95	250	285	1200	600
48	1 7/8	180	120	90	240	270	1200	600
50	1 31/32	175	120	85	230	260	1200	600
51	2	170	115	85	230	255	1200	600
52	2 1/16	165	110	80	220	245	1200	600
54	2 1/8	150	100	75	200	225	1000	500
56	4/6	145	100	75	195	225	1000	500
57	2 1/4	145	100	75	195	225	1000	500
59	2 5/16	145	100	75	195	225	1000	500
60	2 3/8	140	95	70	190	220	1000	500
63	2 31/64	135	90	65	180	205	900	450
64	2 1/2	135	90	65	180	205	900	450
65	2 9/16	130	85	65	175	200	800	400
68	2 11/16	125	80	60	160	185	800	400
73	2 7/8	120	80	60	160	180	800	400
76	3	115	75	55	150	170	700	350
79	3 1/8	110	70	55	140	165	700	350
83	3 1/4	105	50	40	140	155	700	350
86	3 3/8	100	45	30	130	150	500	250
89	3 1/2	95	45	30	130	145	500	250
92	3 5/8	95	60	45	120	140	500	250
95	3 3/4	90	60	45	120	135	500	250
98	3 7/8	90	60	45	120	135	500	250
102	4	85	55	40	110	130	400	200
105	4 1/8	80	55	40	110	120	400	200
111	4 3/8	80	50	40	100	120	300	150
114	4 1/2	75	50	35	100	105	300	150
121	4 3/4	75	50	35	95	95	300	150
127	5	65	45	30	90	90	200	100
133	5 1/4	60	40	25	85	85	200	100
140	5 1/2	60	40	25	85	85	200	100
146	5 3/4	55	35	25	75	75	200	100
152	6	55	35	25	75	75	200	100
160	6 5/16	50	30	25	60	60	150	75
168	6 3/8	50	30	25	55	55	150	75
177	6 31/32	45	25	25	55	55	150	75
200	7 7/8	40	25	25	50	50	100	50
210	8 9/32	40	20	25	50	50	100	50
	-	Cutting oil	Dry	Cutting oil	Cutting oil	Turpentine	Dry	Dry



Speed kills!

Operating at higher speeds than those recommended will shorten the life of the holesaw and produce very inefficient cutting.



Feed Pressure:

Variables in material, work configuration should be considered. Apply sufficient feed pressure to aid good chip re-removal. Reduce the pressure when the holesaw becomes hot or if the teeth start to clog with material. Insufficient feed pressure will dull tooth points prematurely but too much pressure can totally destroy teeth.



Cooling Lubricant:

Cutting oil serves two purposes when sawing in metals. It cools the saw and the work piece. It reduces heat and abrasion which can shorten cutting life. It also aids re-moving swarf from the cutting surface. Using a cooling lubricant will extend the life of your holesaw by 500%.

Hole Dozer[™] holesaw sets

Description	Pack quantity	Min. order quantity	Article Number	EAN Code
7 pc Hole Dozer Holesaw set.				
① Holesaws: Ø 19, 22, 25, 29, 32 mm. Arbor - for holesaws Ø 14 - 30 mm (ld. No. 49567010). Spacer and adaptor. 1/8" Hex allen key.	7	1	49224083	045242310760
10 pc holesaw set.				
② Holesaws: Ø 25, 32, 40, 54, 68, 76 mm. Arbor - for holesaws Ø 14 - 30 mm (ld. No. 49567010). Arbor - for holesaws Ø 32 - 152 mm (ld. No. 49569100). 2 x Pilot drill bits, 1/8" Hex allen key.	10	1	49224201	045242348091
14 pc holesaw set.				
③ Holesaws: Ø 19, 22, 25, 29, 32, 35, 38, 44, 51, 57 mm. Arbor - for holesaws Ø 14 - 30 mm (ld. No. 49567010). Arbor - for holesaws Ø 32 - 152 mm (ld. No. 49569100). 2 x Pilot drill bits, 1/8" ~ 3 mm allen key.	14	1	49224152	045242271047
17 pc holesaw set.				
④ Holesaws: Ø 20, 22, 25, 32, 40, 44, 51, 57, 64, 65, 67, 68, 76 mm. Arbor - for holesaws Ø 14 - 30 mm (ld. No. 49567010). Arbor - for holesaws Ø 32 - 152 mm (ld. No. 49569100). 2 x Pilot drill bits, 1/8" allen key (ld. No. 49960060).	17	1	49224102	045242271054
Holesaw kit box.				
⑤ Arbor with pilot drill (ld. No. 49567010). Arbor with pilot drill (ld. No. 49569100). 2 x Pilot drill bits, 1/8" allen key (ld. No. 49960060).	1	1	4932430327	4002395379880



Hole Dozer™ holesaws bulk packs

NEW

Diameter (mm)	Ø (inch)	Max. cutting depth (mm)	Pack quantity	Min. order quantity	Article Number	EAN Code
19	3/4	41	1	25	49565090	045242176199
20	29/32	41	1	25	49565091	045242528943
22	7/8	41	1	25	49565100	045242156375
25	1	41	1	25	49565110	045242156382
29	1 1/8	41	1	25	49565120	045242156399
30	1 3/16	41	1	25	49565125	045242243976
32	1 1/4	41	1	25	49565130	045242156412
35	1 3/8	41	1	25	49565140	045242156429
38	1 1/2	41	1	25	49565150	045242156436
41	1 5/8	41	1	25	49565152	045242176229
44	1 3/4	41	1	25	49565155	045242176267
51	2	41	1	25	49565160	045242156443
54	2 1/8	41	1	25	49565165	045242176366
57	2 1/4	41	1	25	49565167	045242176373
60	2 3/8	41	1	25	49565169	045242528950
64	2 1/2	41	1	25	49565170	045242156467
67	2 5/8	41	1	16	49565175	045242176380
68	2 11/16	41	1	16	49565178	045242528967
76	3	41	1	16	49565180	045242176397
89	3 1/2	41	1	9	49565190	045242176403
92	3 5/8	41	1	9	49565195	045242176410
102	4	41	1	9	49565200	045242176427
105	4 1/8	41	1	9	49565205	045242176434



Hole Dozer™ holesaws with carbide teeth

NEW

Up to 10x more life, high heat and wear resistance compared to Bi-Metal holesaws. 4 Tpi aggressive tooth geometry with large gullets for improved material removal. Offset teeth for less resistance. PLUG JACK™ slot geometry provides deep access to remove thick plugs and high leverage for thin materials. Application areas: plumbing (ceramic tiles - soft, cast iron), metalworking (stainless steel, high alloy steels, aluminium) and composites (plastics, sandwich material, computer flooring, fibreglass, plastic coated wood boards, nail embedded wood)

Diameter (mm)	Ø (inch)	Max. cutting depth (mm)	Pack quantity	Min. order quantity	Article Number	EAN Code
16	5/8	41	1	1	49560701	045242503957
19	3/4	41	1	1	49560702	045242503971
22	7/8	41	1	1	49560704	045242503995
25	1	41	1	1	49560707	045242504008
29	1 1/8	41	1	1	49560708	045242504015
32	1 1/4	41	1	1	49560710	045242504022
35	1 3/8	41	1	1	49560712	045242504039
38	1 1/2	41	1	1	49560713	045242504053
41	1 5/8	41	1	1	49560715	045242504084
44	1 3/4	41	1	1	49560717	045242504107
48	1 7/8	41	1	1	49560719	045242504114
51	2	41	1	1	49560720	045242504145
54	2 1/8	41	1	1	49560722	045242504152
57	2 1/4	41	1	1	49560724	045242504169
60	2 3/8	41	1	1	49560726	045242504176
64	2 1/2	41	1	1	49560727	045242504183
67	2 5/8	41	1	1	49560729	045242504190
70	2 3/4	41	1	1	49560731	045242504206
73	2 7/8	41	1	1	49560733	045242504213
76	3	41	1	1	49560734	045242504220
83	3 1/4	41	1	1	49560736	045242504237
89	3 1/2	41	1	1	49560738	045242504244
92	3 5/8	41	1	1	49560739	045242504251
95	3 3/4	41	1	1	49560740	045242504268
102	4	41	1	1	49560742	045242504275
108	4 1/4	41	1	1	49560744	045242504282
114	4 1/2	41	1	1	49560746	045242504299
127	5	41	1	1	49560748	045242504305
152	6	41	1	1	49560749	045242504312



System accessories - Hole Dozer[™] holesaws

Description	Fits holesaw Ø	Shank reception	Holesaw or core reception	Pack quantity	Min. order quantity	Article Number	EAN Code
① Fixtec „Twist Release“ quick change arbor.	Ø 14-30 mm	9.5 mm Hex	1/2" x 20	1	1	49567210	045242225774
② Arbor.	Ø 14-30 mm	9.5 mm Hex	1/2" x 20	1	1	49567010	045242200177
③ Arbor.	Ø 32-210 mm	9.5 mm Hex	5/8" x 18	1	1	49567250	045242225798
④ Arbor.	Ø 32-210 mm	11 mm Hex	5/8" x 18	1	1	49569100	045242200832
⑤ Extension - 300 mm long.	-	9.5 mm Hex	-	1	1	48284008	045242225811
⑥ Extension - 300 mm long.	-	11 mm Hex	-	1	1	48284006	045242122516
Pilot drill bit fits to all arbors Ø 6 mm and 89 mm length.				1	1	49568010	045242200450
⑦ Pilot drill long bit fits to all arbors Ø 6 mm and 100 mm length.				1	1	49568000	045242200351
Allen key 1/8" for all arbors.				1	1	49960060	045242221455
Grub screw for arbors.				1	1	06832712	4002395874354



Adjustable hole cutter

For cutting large diameter holes for air conditioning pipes, fans, downlights and ceiling speakers. Dust collection shroud for 100% dust free work when overhead drilling. Diameter is adjustable from 51 mm to 178 mm in 6.4 mm steps. Laser marked preset diameters at 51 - 178 mm. Suitable for use on drywall (max. 25 mm) and ceiling tile. Not suitable for OSB wood boards.

Description	Pack quantity	Min. order quantity	Article Number	EAN Code
Adjustable hole cutter				
① Pilot drill, 2 blades, QL arbor and dust collection shroud.	5	1	49560260	045242350261
② QL arbor with 1/4" Hex reception. 75 mm long.	1	1	48281000	045242122622
Replacement blade and pilot drill set				
③ Pilot drill bit, 2 x blades and allen hex key.	4	1	49560290	045242346370



Diamond Plus™ wet / dry drill bits and holesaws

Diamond grit edge drills and holesaws have been specially developed for professionals that need to drill in extremely hard materials such as porcelain/gres/quarry tiles, cast iron or fibreglass where it is increasingly difficult to drill with conventional holesaws. These holesaws guarantee excellent performance and superior life time even in the hardest of materials.

Water starved: These holesaws only require limited water supply unlike conventional diamond drills that require a continuous flow of water. Just dip the drill bit or holesaw into water at the start of each hole to be cut and thereafter every 5 second cut duration.

Clean holes: Drills clean, precise holes without any perimeter scratches.

Lifetime: To ensure long lifetime, we use high grade diamond for fast cutting and a superior brazed bond matrix to give best durability.

Durability: Tough alloy body which does not bend or distort easily.

Easy slug ejection: Offset slug ejection slots for greater leverage when removing tight slugs.

Versatile: Can be used either on angle grinders with relevant adaptor or with a drill.



Diameter (mm)	Reception	Pack quantity	Min. order quantity	Article Number	EAN Code
5	1/4" Hex	1	1	49560503	045242223732
6	1/4" Hex	1	1	49560505	045242223749
8	1/4" Hex	1	1	49560507	045242223756
10	1/4" Hex	1	1	49560509	045242223763
12	1/4" Hex	1	1	49560511	045242223770
15	1/4" Hex	1	1	49560513	045242223787
20	1/4" Hex	1	1	49560515	045242223794
25	1/4" Hex	1	1	49560517	045242223800

Diameter (mm)	Reception	Pack quantity	Min. order quantity	Article Number	EAN Code
22	1/2" x 20	1	1	49565605	045242308439
29	1/2" x 20	1	1	49565615	045242308446
32	5/8" x 18	1	1	49565620	045242308453
35	5/8" x 18	1	1	49565625	045242308460
38	5/8" x 18	1	1	49565630	045242308477
44	5/8" x 18	1	1	49565640	045242308491
51	5/8" x 18	1	1	49565645	045242308507
68	5/8" x 18	1	1	49565664	045242337835

Application areas

Ceramic tiles – all types hard and soft:
Porcelain/Gres/Granite/Quarry/Terrazzo/
Artificial stone/Terracota/Agglomerate/Glazed

Cast iron

Fibreglass/GRP
(Glass reinforced plastic)/Perspex



Description	Fits holesaw Ø	Shank reception	Holesaw or core reception	Pack quantity	Min. order quantity	Article Number	EAN Code
Arbor.	Ø 14-30 mm	9.5 mm Hex	1/2" x 20	1	1	49567010	045242200177
Arbor.	Ø 32-210 mm	9.5 mm Hex	5/8" x 18	1	1	49567250	045242225798
Grinder adaptor.	Ø 22-29mm	M14	1/2" x 20	1	1	4932430464	4002395381258
Grinder adaptor.	Ø 32-68mm	M14	5/8" x 18	1	1	4932430465	4002395381265

How to use on an angle grinder:

1. Screw the grinder adaptor M14 to the holesaw and tighten firmly with a spanner. Then apply the spindle lock on the angle grinder and fit the adaptor directly onto the spindle; tighten firmly with a spanner.
2. If the tile is not fitted to a wall or floor ensure it is secured firmly with a clamp.
3. Dip the holesaw tips into water.
4. Switch on angle grinder to full speed. Slowly approach the tile with the holesaw at a 20-30° angle with light pressure to avoid skating on the tile. Once the holesaw starts to cut into the tile and forms a groove, gradually raise the holesaw so that it is horizontal with the tile.
5. Every 5 seconds dip the holesaw in water.
6. Apply light pressure and an oscillating circular motion during cutting to maximise tool life.

Holesaw drilling guide

- Drilling guide provides a secure drilling into the material without slipping around and damaging the surface.

Description	Pack quantity	Min. order quantity	Article Number	EAN Code
Drilling guide for drills / holesaws Ø 19 - 68 mm.	1	1	4932352332	4002395369911



IMPACT HOLESAWS



Optimised for use with cordless tools



- ① Thin wall
 - 8 TPI = smooth burr free holes
 - 0.6 mm thick = less resistance
- ② Shallow cup optimised for drilling thin metal
- ③ 8% Cobalt Bi-Metal for best durability and lifetime
- ④ Ejection spring auto ejects slugs
- ⑤ Stop shoulder prevents over drilling
- ⑥ 1/4" Hex shank = impact driver compatible

Suitability

Max. 2 mm steel, aluminium and stainless steel (max. 1.5 mm)

Shockwave impact holesaws

	Diameter (mm)	Pack quantity	Min. order quantity	Article Number	EAN Code
	19	1	1	49569805	045242321094
	22	1	1	49569810	045242321100
	25	1	1	49569815	045242321117
①	29	1	1	49569820	045242321124
	32	1	1	49569825	045242321131
	35	1	1	49569830	045242321148
	38	1	1	49569835	045242321155
②	3 pc Shockwave impact set. Ø 22 / 29 / 35 mm.	3	1	49224800	045242321162
	Ejection spring and grub screw.	1	1	4932430466	4002395381272
	Pilot drill bit with arbor.	1	1	4932430477	4002395381388



Screwdriving bits





The ribs are cold formed to exact specification ensuring reduced wear from slippage. The tip is subjected to a special hardening process with temperatures up to 870°C.

The outcome is a bit with a hardness of 60 HRC. This extra hard tip ensures extra long life under constant use.

The body is manufactured from the highest quality S2 european steel.

The sign of "Quality". All bits are laser marked with the Milwaukee® logo and tip reception for easy identification.

	Type	Total length (mm)	Pack quantity	Min. order quantity	Article Number	EAN Code
Phillips 	PH 1	25	25	1	4932399586	4002395362363
	PH 2	25	25	1	4932399587	4002395362370
	PH 3	25	25	1	4932399588	4002395362387
Pozidrive 	PZ 1	25	25	1	4932399589	4002395362394
	PZ 2	25	25	1	4932399590	4002395362400
	PZ 3	25	25	1	4932399591	4002395362417
Torx 	TX 10	25	25	1	4932399594	4002395362448
	TX 15	25	25	1	4932399595	4002395362455
	TX 20	25	25	1	4932399596	4002395362462
	TX 25	25	25	1	4932399597	4002395362479
	TX 30	25	25	1	4932399599	4002395362493
	TX 40	25	25	1	4932399600	4002395362509

Trade case - 35 pcs

Description	Pack quantity	Min. order quantity	Article Number	EAN Code
-------------	---------------	---------------------	----------------	----------

Screwdriving bit set.

Screwdriving bits 25 mm length: PH 1 x 2 / PH 2 x 3 / PH 3 x 2. PZ 1 x 2 / PZ 2 x 3 / PZ 3 x 2. TX 10 x 2 / TX 15 x 2 / TX 20 x 3. TX 25 x 3 / TX 30 x 2 / TX 40 x 2.
 Screwdriving bits 50 mm length: PH 1 x 1 / PH 2 x 1. PZ 1 x 1 / PZ 2 x 1. TX 20 x 1 / TX 25 x 1.
 Magnetic bit holder with 1/4" Hex reception x 1.

35 1 **4932352068** 4002395367214



Magnetic bit holders

Description	Pack quantity	Min. order quantity	Article Number	EAN Code
-------------	---------------	---------------------	----------------	----------

① Magnetic bit holder with quick release clutch. Total length 58 mm. 1 1 **4932373483** 4002395351060

② Magnetic bit holder for drywall. 1 1 **4932430179** 4002395378401



Compact screwdriving bit cassettes

- This high quality cassette aimed at the professional user is available in 3 different assortments.
- Slimline pocket design: 110 mm x 65 mm x 15 mm.
- Secure latch system - easy opening and safe closing.
- Extra side compartment accepts either 50 mm screwdriving bits or drill bits.
- Front window to protect bits from dust.
- High quality screwdriving bits with hardness of 60 HRC and 1/4" Hex reception. 25 mm bits manufactured according to DIN 3126 - C 6.3. 50 mm bits are manufactured according to DIN 3126 - E 6.3.
- HSS-G Metal drill bits are ground from one piece of solid high speed steel according to DIN 1412 C. Split point shaped cutting tip with 135° angle for improved centering. Type N flue design for fast chip removal. Reception manufactured according to DIN 3126 - E 6.3. Suitable for drilling in steel, cast iron, alloyed and non alloyed material up to 900 N/mm².
- Magnetic bit holder with quick release clutch.

Description	Pack quantity	Min. order quantity	Article Number	EAN Code
12 pc compact screwdriving bit set.				
① 25 mm: SL 0.8 x 5.5 mm x 1. 25 mm: PH 1 x 1 / PH 2 x 2 / PH 3 x 1. 25 mm: PZ 1 x 1 / PZ 2 x 2 / PZ 3 x 1. 50 mm: PH 2 x 1. 50 mm: PZ 2 x 1. Magnetic bit holder with quick release clutch.	12	1	4932399513	4002395361601
27 pc screwdriving bit set.				
② 27 pc robust and compact with an extra big latch. PH 1 x 2 / PH 2 x 2 / PH 3 x 1. PZ 1 x 2 / PZ 2 x 4 / PZ 3 x 2. TX 10 x 2 / TX 15 x 3 / TX 20 x 3. TX 25 x 3 / TX 30 x 1 / TX 40 x 1. Magnetic bit holder with quick release clutch.	27	1	4932352747	4002395374052

①



②



NEW SHOCKWAVE

**ULTIMATE FIT,
BEST DURABILITY**

MADE FROM PROPRIETARY STEEL AND HEAT TREATED TO CONTROL HARDNESS, INNOVATIVELY DESIGNED GEOMETRIC SHOCK ABSORPTION ZONE TO EXTEND LIFE.



UP TO
30x
LIFE™*



SHOCKZONE™
ABSORBS MORE
TORQUE



CUSTOM
MACHINED TIP™
PRECISE FIT

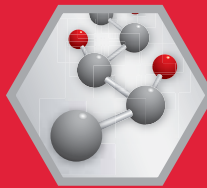

CUSTOM
ALLOY™ 76
STEEL

The true **high performance solution** for your **impact driver**

SHOCKWAVE  **IMPACT DUTY**™



*vs. standard no impact bits

Shockwave Impact Duty™ screwdriving bits

IMPACT

Designed for use with Impact Drivers the Shockwave Impact Duty™ accessory line is not only ideal for heavy duty impact applications, but also delivers a full system solution for all the user's drilling and fastening needs.

Shock Zone Geometry - Designed to Flex.



The larger optimized Shock Zone are reduces stress at the tip resulting in less tip breakages. The combination of the Shock Zone design and special heat treatment absorbs impacts and allows the bit to flex with spring like action.

Precision milled tip provides the best fit with screw head, reducing cam out and stripping, resulting in outstanding lifetime.

Custom engineered steel - Milwaukee® custom metal formula makes the Shockwave bits more resistant to shock from impacting.



A) 25 mm ¼" Hex - DIN 3126 - C 6.3
B) 50 mm ¼" Hex - DIN 3126 - E 6.3
C) 90 mm ¼" Hex - DIN 3126 - E 6.3

	Type	Total length (mm)	Supplied in	Pack quantity	Min. order quantity	Article Number	EAN Code
Phillips 	PH 1	25	①	2	1	4932430850	4002395385126
		90	①	1	1	4932430851	4002395385133
	PH 2	25	①	2	1	4932430852	4002395385140
		25	②	25	10	4932430853	4002395385157
		50	①	1	1	4932430854	4002395385164
		50	②	10	10	4932430855	4002395385171
		90	①	1	1	4932430856	4002395385188
	PH 3	25	①	2	1	4932430857	4002395385195
		50	①	1	1	4932430858	4002395385201
90		①	1	1	4932430859	4002395385218	
Pozidrive 	PZ 1	25	①	2	1	4932430860	4002395385225
		25	②	25	10	4932430861	4002395385232
		90	①	1	1	4932430862	4002395385249
	PZ 2	25	①	2	1	4932430863	4002395385256
		25	②	25	10	4932430864	4002395385263
		50	①	1	1	4932430865	4002395385270
		50	②	10	10	4932430866	4002395385287
		90	①	1	1	4932430867	4002395385294
	PZ 3	25	①	2	1	4932430868	4002395385300
			②	25	10	4932430869	4002395385317
		50	①	1	1	4932430870	4002395385324

① Blister



② Storage container





Minimum order quantity = 10 pcs (come in counter display) Orders > 10 pcs must be ordered in multiples of 10 (i.e. 10, 20, 30)

Counter display



SHOCKWAVE TM

IMPACT DUTY

	Type	Total length (mm)	Supplied in	Pack quantity	Min. order quantity	Article Number	EAN Code
	TX 10	25	①	2	1	4932430871	4002395385331
		25	①	2	1	4932430872	4002395385348
		25	②	25	10	4932430873	4002395385355
		50	①	1	1	4932451286	4002395157440
	TX 20	25	①	2	1	4932430874	4002395385362
		25	②	25	10	4932430875	4002395385379
		50	①	1	1	4932430876	4002395385386
		50	②	10	10	4932430877	4002395385393
		90	①	1	1	4932430878	4002395385409
	TX 25	25	①	2	1	4932430879	4002395385416
		25	②	25	10	4932430880	4002395385423
		50	①	1	1	4932430881	4002395385430
		50	②	10	10	4932430882	4002395385447
		90	①	1	1	4932430883	4002395385454
	TX 27	25	①	2	1	4932430884	4002395385461
	TX 30	25	①	2	1	4932430885	4002395385478
		25	②	25	10	4932430886	4002395385485
		50	①	1	1	4932430887	4002395385492
	TX 40	25	①	2	1	4932430888	4002395385508
		25	②	25	10	4932430889	4002395385515
50		①	1	1	4932430890	4002395385522	
TX 50	25	①	2	1	4932430891	4002395385539	
	25	②	20	10	4932430892	4002395385546	
	Hex 2.5 mm	25	①	2	1	4932430893	4002395385553
	Hex 3 mm	25	①	2	1	4932430894	4002395385560
	Hex 4 mm	25	①	2	1	4932430895	4002395385577
	Hex 5 mm	25	①	2	1	4932430896	4002395385584
	Hex 6 mm	25	①	2	1	4932430897	4002395385591
	Hex 8 mm	25	①	2	1	4932430898	4002395385607
	Hex 10 mm	25	①	2	1	4932430899	4002395385614
	Hex 12 mm	25	①	2	1	4932430900	4002395385621
	SL 0.6 x 4.5	25	①	2	1	4932430901	4002395385638
	SL 0.8 x 5.5	25	①	2	1	4932430902	4002395385645
	SL 1.2 x 6.5	25	①	2	1	4932430903	4002395385652

① Blister



② Storage container



Minimum order quantity = 10 pcs (come in counter display) Orders > 10 pcs must be ordered in multiples of 10 (i.e. 10, 20, 30)

Counter display



Shockwave Impact Duty™ sets

Description	Pack quantity	Min. order quantity	Article Number	EAN Code
15 pc Shockwave puck set ① Shockwave Impact Duty™ screwdriving bits: 15 x 25 mm length: 1 x PH1 / 2 x PH2. 1 x PZ1 / 2 x PZ2 / 1 x PZ3. 1 x TX10 / 2 x TX15 / 2 x TX20 / 1 x TX25 / 1 x TX30. 1 x magnetic bit holder 60 mm length.	15	10	4932430904	4002395385669
33 pc Shockwave bits & nut drivers set ② Shockwave Impact Duty™ screwdriving bits: 24 x 25 mm length: 1 x PH1 / 2 x PH2 / 1 x PH3, 2 x PZ1 / 3 x PZ2 / 2 x PZ3, 2 x TX10 / 2 x TX15 / 3 x TX20 / 2 x TX25 / 2 x TX30 / 1 x TX40 / 1 x TX50. 5 x 50 mm length: 1 x PH2 / 1 x PZ2, 1 x TX15 / 1 x TX20 / 1 x TX25. 3 x Shockwave Impact Duty™ magnetic nut drivers: 48 mm length 1 x Hex 7 mm / 1 x Hex 8 mm / 1 x Hex 10 mm. 1 x magnetic bit holder 60 mm length.	33	6	4932430905	4002395385676
62 pc Shockwave bit set NEW Shockwave Impact Duty™ screwdriving bits: 27 x 25 mm length: 2 x PH1 / 4 x PH2 / 1 x PH3, 3 x PZ1 / 4 x PZ2 / 2 x PZ3, 2 x TX15 / 2 x TX20 / 2 x TX25 / 2 x TX30 / 1 x TX40, 1 x Hex 3 mm / 1 x Hex 4 mm. 16 x 50 mm length: 1 x PH1 / 2 x PH2, 1 x PZ1 / 2 x PZ2 / 1 x PZ3, 2 x TX15 / 2 x TX20 / 2 x TX25 / 2 x TX30. 6 x 90 mm length: 1 x PH2, 1 x PZ1 / 1 x PZ2, 1 x TX15 / 1 x TX25 / 1 x TX30. 1 x magnetic bit holder 60 mm length, 1 x magnetic bit holder 152 mm length. 2 x Shockwave Impact Duty™ sockets 1/2" square 78 mm length: 19 mm / 21 mm. 3 x Shockwave Impact Duty™ nut drivers 48 mm length: Hex 7 mm / Hex 8 mm / Hex 10 mm. 5 x Shockwave Impact Duty™ 1/4" Red Hex drill bits: Ø 3 mm / 4 mm (2) / 5 mm (2) / 6 mm / 7 mm.	62	6	4932464168	4058546221133
24 pc Shockwave bit set NEW Shockwave Impact Duty™ screwdriving bits: 13 x 25 mm length: 1 x PH1 / 2 x PH2 / 1 x PH3, 1 x PZ1 / 3 x PZ2 / 1 x PZ3, 1 x TX15 / 1 x TX20 / 1 x TX25 / 1 x TX30. 10 x 50 mm length: 1 x PH1 / 1 x PH2, 1 x PZ1 / 2 x PZ2 / 1 x PZ3, 1 x TX15 / 1 x TX20 / 1 x TX25 / 1 x TX30. 1 x magnetic bit holder 60 mm length.	24	6	4932464169	4058546221140
31 pc Shockwave bit set NEW Shockwave Impact Duty™ screwdriving bits: 23 x 25 mm length: 1 x PH1 / 2 x PH2 / 1 x PH3, 1 x PZ1 / 2 x PZ2 / 1 x PZ3, 2 x TX15 / 2 x TX20 / 1 x TX25 / 2 x TX30 / 1 x TX40 / 1 x TX50, 1 x Hex 4 mm / 1 x Hex 5 mm / 1 x Hex 6 mm / 1 x Hex 8 mm / 1 x Hex 10 mm / 1 x Hex 12 mm. 1 x magnetic bit holder 60 mm length, 1 x magnetic bit holder 152 mm length. 3 x Shockwave Impact Duty™ automotive sockets 1/2" square: 85 mm length: 17 mm / 19 mm / 21 mm. 3 x Shockwave Impact Duty™ nut drivers 48 mm length: Hex 8 mm / Hex 10 mm / Hex 13 mm.	31	6	4932464170	4058546221157



SHOCKWAVE IMPACT DUTY™

Shockwave Impact Duty™ sets

Description	Pack quantity	Min. order quantity	Article Number	EAN Code
<p>48 pc Shockwave drill & drive set</p> <p>Shockwave Impact Duty™ screwdriving bits: 32 x 25 mm length 2 x PH1 / 2 x PH2 / 1 x PH3, 2 x PZ1 / 3 x PZ2 / 1 x PZ3, 3 x TX10 / 3 x TX15 / 3 x TX20 / 3 x TX25 / 3 x TX30 / 1 x TX40, 1 x Hex 4 mm / 1 x Hex 5 mm, 1 x SL 0.6 x 4.5 / 1 x SL 0.8 x 5.5 / 1 x SL 1.2 x 6.5. 8 x 50 mm length 1 x PH1 / 1 x PH2, 1 x PZ1, 1 x TX10 / 1 x TX15 / 1 x TX20 / 1 x TX25 / 1 x TX30. 3 x 90 mm length 1 x PZ2, 1 x TX20 / 1 x TX25. 1 x magnetic bit holder 60 mm length. 4 x Shockwave Impact Duty™ 1/4" Hex drill bits: Ø 3 / 4 / 5 / 6 mm.</p>	48	6	4932430906	4002395385683
<p>56 pc Shockwave drive set</p> <p>Shockwave Impact Duty™ screwdriving bits: 48 x 25 mm length 2 x PH1 / 3 x PH2 / 1 x PH3, 3 x PZ1 / 4 x PZ2 / 2 x PZ3, 3 x TX10 / 3 x TX15 / 4 x TX20 / 4 x TX25 / 4 x TX30 / 3 x TX40 / 2 x TX50, 2 x Hex 4 mm / 2 x Hex 5 mm, 2 x SL 0.6 x 4.5 / 2 x SL 0.8 x 5.5 / 2 x SL 1.2 x 6.5. 7 x 50 mm length 1 x PH2, 1 x PZ1 / 1 x PZ2, 1 x TX10 / 1 x TX15 / 1 x TX20 / 1 x TX25. 1 x magnetic bit holder 60 mm length.</p>	56	6	4932430907	4002395385690
<p>40 pc Shockwave drill & drive set</p> <p>Shockwave Impact Duty™ screwdriving bits: 25 x 25 mm length 1 x PH1 / 2 x PH2, 1 x PZ1 / 3 x PZ2, 2 x TX10 / 2 x TX15 / 3 x TX20 / 2 x TX25 / 2 x TX30 / 1 x TX40 / 1 x TX50, 1 x Hex 4 mm / 1 x Hex 5 mm, 1 x SL 0.6 x 4.5 / 1 x SL 0.8 x 5.5 / 1 x SL 1.2 x 6.5. 8 x 50 mm length 1 x PH2, 1 x PZ1 / 1 x PZ2, 1 x TX10 / 1 x TX15 / 1 x TX20 / 1 x TX25 / 1 x TX30. 1 x magnetic bit holder 60 mm length. 1 x magnetic bit holder 152 mm length. 3 x Shockwave Impact Duty™ 1/4" Hex drill bits: Ø 3 / 4 / 5 mm. 2 x Shockwave Impact Duty™ magnetic nut drivers: 48 mm length 1 x Hex 8 mm / 1 x Hex 10 mm.</p>	40	6	4932430908	4002395385706



①



②



③



Shockwave Impact Duty™ drive guide cassettes

- Slimline pocket design.
- Drive Guide bit holder with extendable sleeve to hold long screws secure. Up to 110 mm total length.
- Front loading screwdriver handle.
- Metal wire stripper for Ø 0.75 / 1.0 / 1.5 / 2.5 mm² .
- Wire loop maker up to 5 mm² .



Description	Total length (mm)	Pack quantity	Min. order quantity	Article Number	EAN Code
-------------	-------------------	---------------	---------------------	----------------	----------

12 pc Shockwave drive guide set 1

① 1 x PH2, 1 x PZ1 / 2 x PZ2 / 1 x PZ3, 1 x TX20 / 1 x TX25, 1 x SL 0.6 x 4.5 mm / 1 x SL 0.8 x 5.5 mm, 1 x Hex 4 / 1 x Hex 5, 1 x drive guide bit holder 76 mm length.	25	12	10	4932430909	4002395385713
---	----	----	----	------------	---------------

①



12 pc Shockwave drive guide set 2

② 1 x PH2, 1 x PZ1 / 2 x PZ2 / 1 x PZ3, 1 x TX15 / 1 x TX20 / 2 x TX25 / 1 x TX30 / 1 x TX40, 1 x drive guide bit holder 76 mm length.	25	12	10	4932430910	4002395385720
--	----	----	----	------------	---------------

②



12 pc Shockwave drive guide set 3

③ 2 x TX10 / 3 x TX15 / 2 x TX20 / 2 x TX25 / 1 x TX30 / 1 x TX40, 1 x drive guide bit holder 76 mm length.	25	12	10	4932430911	4002395385737
---	----	----	----	------------	---------------

③



Automotive socket set

- Colour coded for easy identification.
- Made from high quality alloy steel for strength and durability.
- Set includes 17 mm, 19 mm and 21 mm.

Description	Pack quantity	Min. order quantity	Article Number	EAN Code
-------------	---------------	---------------------	----------------	----------

Automotive socket set.

17, 19 and 21 mm 1/2" sockets.

3	1	4932451568	4002395140091
---	---	------------	---------------



SHOCKWAVE IMPACT DUTY™

1/2" Sockets

- Impact duty (Chrome-Molybdenum) steel is high quality alloy steel which provides ultimate strength and durability.
- Best fitting thanks to 6 gripping points.
- Recessed corners allow torque to be transferred across the flats of the socket rather than producing stress on the points or corners.
- Thin wall construction provides access to tight spaces.
- Deep wall construction provides clearance for protruding bolts.
- Laser etched size markings for easy identification and won't wear off.
- Up to 4500 Nm torque.

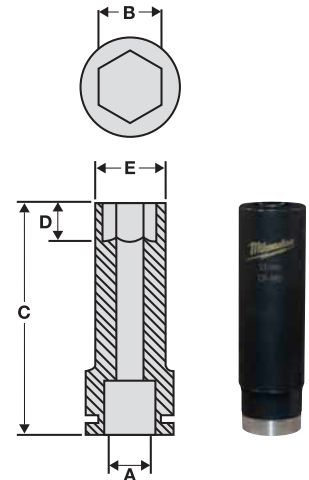

A (MM)	B (MM)	C (MM)	D (MM)	E (MM)	For anchor thread size	Pack quantity	Min. order quantity	Article Number	EAN Code
1/2" square	8	78	12	15	M5	1	1	4932352847	4002395375059
1/2" square	10	78	12	17	M6	1	1	4932352848	4002395375066
1/2" square	11	78	12	18	-	1	1	4932352849	4002395375073
1/2" square	12	78	12	19	M7	1	1	4932352850	4002395375080
1/2" square	13	78	12	20	M8	1	1	4932352851	4002395375097
1/2" square	14	78	15	22	M9	1	1	4932352852	4002395375103
1/2" square	16	78	15	23.8	-	1	1	4932352853	4002395375110
1/2" square	17	78	18	25.8	M10	1	1	4932352854	4002395375127
1/2" square	19	78	21	27.8	M12	1	1	4932352855	4002395375134
1/2" square	21	78	24	29.8	-	1	1	4932352856	4002395375141
1/2" square	24	78	24	33.8	M16	1	1	4932352857	4002395375158
1/2" square	27	78	24	37.8	M18	1	1	4932352858	4002395375165
1/2" square	30	78	24	41.8	M20	1	1	4932352859	4002395375172
1/2" square	32	78	24	43.8	M22	1	1	4932352860	4002395375189

10 piece Shockwave Impact Duty™ 1/2" socket set.

① Contents: 8 / 10 / 11 / 12 / 13 / 14 / 16 / 17 / 19 / 21 mm.	10	1	4932352861	4002395375196
--	----	---	------------	---------------



1/4" Sockets

Description	Pack quantity	Min. order quantity	Article Number	EAN Code
-------------	---------------	---------------------	----------------	----------

20 pc Shockwave Impact Duty™ 1/4" socket set

① 12 x 1/4" sockets: 4 / 4.5 / 5 / 5.5 / 6 / 7 / 8 / 9 / 10 / 11 / 12 / 13 mm. 50 mm total length. 6 x screwdriving bits 25 mm in length: PH 2, PZ 2, TX 15, TX 20, TX 25, TX 30. 1 x socket adaptor 1/4" Hex > 1/4" square drive. 1 x bit adaptor 1/4" square (F) > 1/4" Hex. Magnetic bit holder for screwdriving bits.	20	1	4932352862	4002395375202
---	----	---	------------	---------------

A	B (MM)	C (MM)	D (MM)	E (MM)	F (MM)
1/4"	4	50	3	7.7	12.8
1/4"	4.5	50	3.5	8	12.8
1/4"	5	50	4	8.8	12.8
1/4"	5.5	50	4.5	9.5	12.8
1/4"	6	50	6	9.8	12.8
1/4"	7	50	6	11.4	12.8
1/4"	8	50	7.5	12.5	12.8
1/4"	9	50	7.5	13.8	13.8
1/4"	10	50	9	14.3	14.3
1/4"	11	50	11	16.8	16.8
1/4"	12	50	12	17.8	17.8
1/4"	13	50	12	18.8	18.8

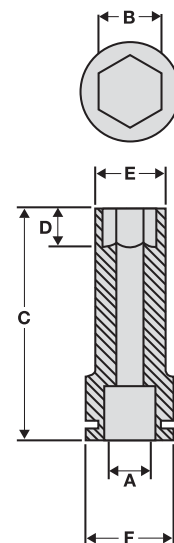

Magnetic bit holder

Custom engineered steel and heat treatment for maximum strength and flexibility.
 Solid construction withstands abuse in impact applications.
 Strong magnetic tip for secure grip.

Description	Total length (mm) A	Pack quantity	Min. order quantity	Article Number	EAN Code
① Magnetic bit holder with 1/4" Hex reception (DIN 3126 - E 6.3).	60	1	1	4932352406	4002395370658
② 100 pcs bulk box. Orders are only possible in multiples of 100 pcs (i.e. 200, 300...). Minimum order quantity is 100 pcs.	60	1	100	4932430478	4002395381395
③ Magnetic bit holders- long series 152 mm with 1/4" Hex reception (DIN 3126 - E 6.3).	152	1	1	48324511	045242301980
④ Magnetic bit holders- long series 305 mm with 1/4" Hex reception (DIN 3126 - E 6.3).	305	1	48324512	045242301997	

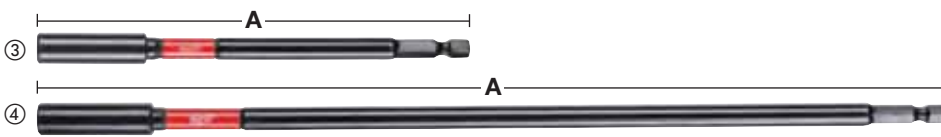
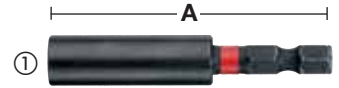

Locking bit holders

NEW

Custom engineered steel - Milwaukee® custom metal formula makes the Shockwave bits more resistant to shock from impacting.
 Optimised Shockzone absorbs up to 3X more torque.
 Dual internal magnets ensures magnetism to fasteners.
 Auto-Locking - One handed bit release.
 Slim profile maximises access.
 Shockwave Impact Duty™ - Optimised for impact drivers.

Description	Total length (mm) A	Pack quantity	Min. order quantity	Article Number	EAN Code
① Locking bit holder 1/4" Hex reception 73 mm long.	73	1	1	4932459398	4058546010591
② Locking bit holder 1/4" Hex reception 152 mm long.	152	1	1	48324532	045242483488
③ Locking bit holder 1/4" Hex reception 305 mm long.	305	1	1	48324533	045242483495

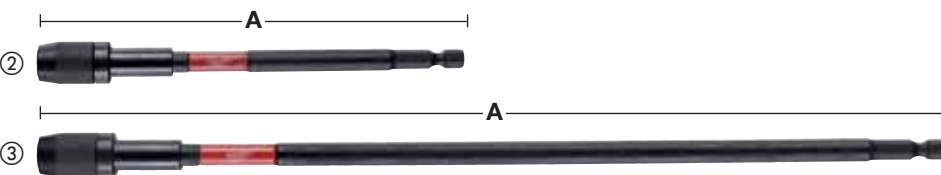

SHOCKWAVE IMPACT DUTY TM

Socket and bit adaptors

Description	Total length (mm)	Pack quantity	Min. order quantity	Article Number	EAN Code
① Socket adaptor: 1/4" Hex - 1/4" square drive. DIN 3126 - E 6.3.	50	1	1	48325030	045242195039
② Socket adaptor: 1/4" Hex - 1/2" square drive. DIN 3126 - E 6.3.	50	1	1	48325032	045242195046
③ Bit adaptor: 1/2" square drive - 1/4" F. To accept screwdriving bits.	50	1	1	48034410	



KNUCKLETM

Offset attachment for heavy duty impact applications.

- Impact rated. Can be used with both cordless and impact drills.
- Very compact offset attachment.
- Ideally suited to working in confined and limited spaces.
- Solid metal construction to absorb impact action.
- 0° and 30° positions.
- 1/4" Hex shank fits directly into the chuck preventing slippage.
- Suitable for use with 1/4" Hex impact drivers up to 180 Nm torque.



* Height when 30° tilted 40 mm



Description	Pack quantity	Min. order quantity	Article Number	EAN Code
KnuckleTM				
1 x Knuckle TM , 1 x PH1 / 2 x PH2, 1 x PZ1 / 2 x PZ2 / 1 x PZ3, 1 x TX15 / 1 x TX20 / 1 x TX25.	11	1	4932459781	4058546029531



Magnetic nut drivers

Custom engineered steel and heat treatment for maximum strength and extreme durability. Strong magnetic tip for secure grip. Reception: 1/4" Hex (DIN 3126 - E 6.3). Very suitable for high torque and impact applications.

Size AF (across flats) (mm)	For anchor rod thread size	Total length (mm) A	Pack quantity	Min. order quantity	Article Number	EAN Code
5.5	M3	65	1	1	4932352536	4002395371945
6.0	M3.5	65	1	1	4932352537	4002395371952
1/4"	-	65	1	1	4932352538	4002395371969
7.0	M4	65	1	1	4932352539	4002395371976
5/16"	-	65	1	1	4932352540	4002395371983
8.0	M5	65	1	1	4932352541	4002395371990
3/8"	-	65	1	1	4932352542	4002395372003
10.0	M6	65	1	1	4932352543	4002395372010
12.0	M7	65	1	1	4932352544	4002395372027
13.0	M8	65	1	1	4932352545	4002395372034
17.0	M10	65	1	1	4932352546	4002395372041
① 5 piece Shockwave Impact Duty [™] nut driver set. Ø 7 / 8 / 10 / 12 / 13 mm.			5	1	4932352822	4002395374809



OSD2 - Offset Screwdriver/ drill

The **OSD 2** screwdriver / drill angle attachment is the ideal solution for all screwdriving and drilling applications in restricted areas.



1/4" magnetic Hex bit reception accepts both standard 25 mm (C 6.3) and ball end reception (E 6.3), with bit locking mechanism.

Metal gears and housing for smooth and precise running and excellent power transmission.

360° rotatable softgrip side handel for left and right hand use with 4 lock positions.

Two step Hex shaft to fit either 1/4" (6 mm) Hex shaft or 10 mm Hex shaft.

Industrial quality designed for use with all cordless tools in applications up to 40 Nm torque and a maximum of 1750 rpm.

The OSD2 is capable of both drilling and screwdriving applications offering maximum versatility.

Only 51 mm in height for use in confined spaces.



Description	Pack quantity	Min. order quantity	Article Number	EAN Code
① OSD 2 Counter display.	1	1	4932352320	4002395369799
② 6 x OSD 2 (single OSD 2 4932352320).	6	1	4932352321	4002395369805

System attachments - Screwdrivers

Description	Fits corded screwdrivers	Pack quantity	Min. order quantity	Article Number	EAN Code
① Drywall sleeve assembly.	DWE 4000 Q, DWSE 4000 Q, TKSE 2500 Q, 6790, 6743	1	1	49261036	045242185245
② Self drill sleeve assembly.	TKSE 2500 Q, 6790	1	1	49261082	045242185375
Magnetic bit holder 1/4". Length 76 mm.	DWE 4000 Q, DWSE 4000 Q, 6743	1	1	48323065	045242128600
Magnetic bit holder 1/4". Length 76 mm. Requires additionally 49261036 sleeve assembly.	TKSE 2500 Q, 6790	1	1	48323070	045242128655
3 piece Hexagon socket set.					
③ Ø 6 / 8 / 10 mm magnetic sockets.		3	1	49663004	045242207848
④ M12 BDDX-OA Offset attachment for screwdriving applications. 12 fixing positions.		1	1	4932430432	4002395380930
⑤ M12 BDDX-RAA Right angle attachment for drilling and screwdriving applications in confined spaces. 90° angle. 12 fixing positions. Direct bit reception.		1	1	4932430433	4002395380947
⑥ Collated attachment for M18 FSG.		1	1	4933459202	4002395289974
⑦ PH2 148 mm screwdriving bit for M18 FSG.		3	1	4932459393	4058546010546
⑧ Mag / Ring Bit Holder 75 mm for M18 FSG.		1	1	4932459394	4058546010553



System attachments - Sharp-Fire screwdrivers

Description	Fits corded screwdrivers	Pack quantity	Min. order quantity	Article Number	EAN Code
① Square drive bit. For use with Sharp-Fire magazine 48051000. 120 mm long.	DWE 4000 Q, SE 2500 LMQ, TKSE 2500 Q	1	1	48301526	045242124312
① Square drive bit. For use with Sharp-Fire magazine 48051005. 140 mm long.	DWE 4000 Q, SE 2500 LMQ, TKSE 2500 Q	1	1	48301527	045242124329
② Phillips drive bit. For use with Sharp-Fire magazine 48051005. 140 mm long.	DWE 4000 Q, SE 2500 LMQ, TKSE 2500 Q	1	1	48301528	045242124336

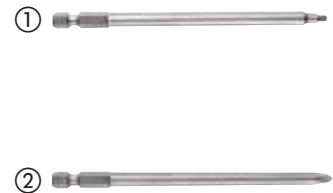







System attachments - Impact wrenches

Description	Pack quantity	Min. order quantity	Article Number	EAN Code
Detent pin square type. Socket will not slip off unless detent pin is pressed in.	1	1	49170405	045242178919
① Adaptor 1/2" square drive to 7/16" and Hex 11 mm. For use with 7/16" selffeed bits and impact auger bits.	1	1	48660061	045242155118



Description	Pack quantity	Min. order quantity	Article Number	EAN Code
Rubber Sleeve for M18 CIW	1	1	49162754	045242320455
Rubber Sleeve for M18 CHIW & M28 CHIW	1	1	49162763	045242324255
② Rubber Sleeve for M18 FMTIWP	1	1	49162861	045242510146
Rubber Sleeve for M18 FHIWP12	1	1	49162766	045242506415
Rubber Sleeve for M18 FHIWF12	1	1	49162767	045242506422

FIXTEC and SDS-plus chuck adaptors

Tool Drive	Reception	Id. No. 4932	EAN Code 4002395	
① FIXTEC	SDS-plus	379877	346561	① 
② FIXTEC	SDS-plus	399152	357628	② 
③ FIXTEC	SDS-plus	352299	369584	③ 
④ FIXTEC	1/2" x 20 UNF	371807	344710	④ 
⑤ FIXTEC	1/2" x 20 UNF	399154	357635	⑤ 
<p>Only suitable for PLH 16 QEX, V28 HX, V18 HX, PLH 26 QEX, PH 30 Power X, KH 26 XE, KH 24 XE, KH 28 Super XE, BH 26 LXE and PH 26 X.</p>				
⑥ SDS-plus	1/2" x 20 UNF	367438	337668	⑥ 
<p>Chuck adaptor with direct bit reception (1/4" Hex) to accept screwdriving bits. Threaded housing enables adaptor to be tightened to the chuck resulting in no wobble.</p>				
⑦ SDS-plus	1/2" x 20 UNF	367166	334438	⑦ 
<p>Chuck adaptor with retaining screw.</p>				

Keyed chucks

Chuck jaws open (mm)	Drill reception	Locking device	Safety screw	Rotary drill	Percussion drill	Battery drill	Chuck key	Pack quantity	Min. order quantity	Article Number	EAN Code
1.0-10 1/2" x 20		✓	✓	✓	✓	✓	A	1	1	4932269401	4002395302932
1.5-13 1/2" x 20		✓	✓	✓	✓	✓	A	1	1	4932267980	4002395300488
1.0-16 Taper B16				✓			C	1	1	4932127010	4002395306169
3.0-16 M18x2.5	✓	✓	✓	✓	✓		C	1	1	4932320014*	4002395310784
3.0-16 1/2" x 20				✓	✓		C	1	1	4932363753	4002395332953



Keyed chucks - machine specific

Chuck jaws open (mm)	Drill reception	Fits drill drivers	Safety screw	Chuck key	Pack quantity	Min. order quantity	Article Number	EAN Code
1.0-10	3/8" x 24	HDE 6 RQ	✓	H	1	1	48660817	045242155705
2.0-13	1/2" x 20	HDE 13 RQD	✓	K	1	1	48661355	045242156542



Keyed chucks with 1/4" Hex reception

Chuck jaws open (mm)	Drill reception	Battery drill	Chuck key	Pack quantity	Min. order quantity	Article Number	EAN Code
0.5-6.5	1/4" Hex	✓	D	1	1	4932314867	4002395300112



Chuck keys

Description	Type	Ref. No.	Pack quantity	Min. order quantity	Article Number	EAN Code
① Chuck key	A	S2A	1	1	4932221378	4002395302765
	B	S2AT	1	1	4932310612	4002395309177
	C	S3T	1	1	4932221379	4002395306381
	D	S14	1	1	4932304684*	4002395300105
	E	S4	1	1	4932221380	4002395306398
	G	S2	1	1	4932319995	4002395303724
	H		1	1	48663350	045242157600
	J		1	1	48663240	045242157501
	K		1	1	48663280	045242157556
② Spanner (SW13) to remove chucks.			1	1	4932315788	4002395302611
③ Morse taper No. 3 adaptor for chucks with B16 taper.	MT3 - B16		1	1	4932117042	4002395305834
Ejector tool DIN 317 size 3.			1	1	4932604226	4002395311248

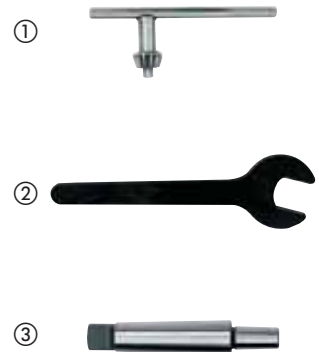

* while stocks last

Keyless chucks

Chuck jaws open (mm)	Reception	Locking device	Safety screw	Rotary drill	Percussion drill	Battery drill	Pack quantity	Min. order quantity	Article Number	EAN Code
1.0-10	3/8" x 24		✓	✓		✓	1	1	4932349457	4002395318155
1.0-10	1/2" x 20	✓	✓	✓	✓	✓	1	1	4932364382	4002395337675
1.5-13	1/2" x 20	✓		✓	✓	✓	1	1	4932376531	4002395346332
1.5-13	1/2" x 20	✓	✓	✓	✓	✓	1	1	4932376533	4002395346349
1.5-13	1/2" x 20	✓		✓	✓	✓	1	1	4932364265*	4002395334056
1.5-13	1/2" x 20	✓	✓	✓	✓	✓	1	1	4932364267*	4002395334070



* Industrial quality

Keyless chucks for FIXTEC (spindle lock) machines

Chuck jaws open (mm)	Reception	Locking device	Safety screw	Rotary drill	Percussion drill	Battery drill	Pack quantity	Min. order quantity	Article Number	EAN Code
1.0-10	3/8" x 24	✓	✓	✓	✓	✓	1	1	4932371018	4002395339365
1.0-10	1/2" x 20	✓	✓	✓	✓	✓	1	1	4932372443	4002395345458
1.5-13	1/2" x 20	✓	✓	✓	✓	✓	1	1	4932371913	4002395345366
1.5-13	3/8" x 24	✓	✓	✓	✓	✓	1	1	4932399492	4002395361137



Industrial keyless chucks for percussion drills

Chuck jaws open (mm)	Reception	Locking device	Rotary drill	Percussion drill	Battery drill	Pack quantity	Min. order quantity	Article Number	EAN Code
1.0-13	1/2" x 20	✓	✓	✓	✓	1	1	4932364266	4002395334063



Keyless chucks - specific tool related chucks

Chuck jaws open (mm)	Reception	Machine specific	Locking device	Rotary drill	Safety screw	Pack quantity	Min. order quantity	Article Number	EAN Code
① 1.0-10	1/2" x 20	HDE 10 RQX			✓	1	1	48661520	045242156795
① 1.5-13	1/2" x 20	HDE 13 RQX			✓	1	1	42660755	4002395891436
② 1.5-13	FIXTEC		✓	✓		1	1	4932399214	4002395358236
③ 1.0-10	FIXTEC	M12 BDDX		✓		1	1	4932430444	4002395381050



Wet Diamond Drilling Cores

WCHP-SB
8–50 mm



- ① Standard 1/2" G reception
- ② Standard 1 1/4" UNC reception
- ③ Engraving of diameter and type on the core reception for longterm visibility
- ④ Laser welded segments guarantee against break off
- ④ 10 mm segment height for superior lifetime



WCHP-SB
52–152 mm



WCHP
52–350 mm



- Extra thin 2 mm segment for fast and aggressive drilling in reinforced concrete
- Closed ring segment for outstanding performance in tough applications

- Uniquely designed TURBO shaped segments
- Pre-grinded, for best performance right from the first hole
 - One outer and two inner slots enable improved cooling and increased material removal

Material	WCHP-SB WCHP
Aerated/breeze concrete blocks	✓
Artificial stone – hard	✗
Asphalt	✗
Concrete pipes	✓
Concrete reinforced – very abrasive: e.g. – with flint aggregate – with silex (flint) aggregate – soft/green concrete	◆
Concrete reinforced – low abrasive: e.g. – with limestone aggregate	✓
Concrete reinforced – with hard aggregates: e.g. – with granite aggregate – quartz sand aggregate	✓
Fireclay bricks	✗
Lime/sandstone blocks – very hard	✗
Lime/sandstone blocks – medium to hard	◆
Lime/sandstone blocks – soft/abrasive	◆
Granite	✗
Marble	◆
Porphyry	✗
Screed	✓
Stoneware/clay pipes	◆
Slate	◆
Tiles – hard	◆
Tiles – soft	◆

✓ Most suitable. Recommended for these materials.

◆ Limited suitability – recommended for intermittent use. Very good drilling characteristics, but reduced lifetime.

✗ Not suitable. Not recommended for these materials.

Wet diamond drilling cores

Diameter (mm)	Description	Fits DD3-152	Fits DCM2-250C & DCM2-350C	Core reception	Working length (mm) B	Total length (mm) A	Pack quantity	Min. order quantity	Article Number	EAN Code
8	WCHP-SB 8	✓	◆	1/2" G	70	135	1	1	4932352072	4002395367269
12	WCHP-SB 12	✓	◆	1/2" G	200	265	1	1	4932352074	4002395367283
14	WCHP-SB 14	✓	◆	1/2" G	300	365	1	1	4932352075	4002395367290
16	WCHP-SB 16	✓	◆	1/2" G	300	365	1	1	4932352077	4002395367313
18	WCHP-SB 18	✓	◆	1/2" G	300	365	1	1	4932352078	4002395367320
20	WCHP-SB 20	✓	◆	1/2" G	300	365	1	1	4932352079	4002395367337
22	WCHP-SB 22	✓	◆	1/2" G	300	365	1	1	4932352080	4002395367344
24	WCHP-SB 24	✓	◆	1/2" G	300	365	1	1	4932352081	4002395367351
25	WCHP-SB 25	✓	◆	1/2" G	300	365	1	1	4932352082	4002395367368
28	WCHP-SB 28	✓	◆	1/2" G	300	365	1	1	4932352083	4002395367375
30	WCHP-SB 30	✓	◆	1/2" G	300	365	1	1	4932352084	4002395367382
32	WCHP-SB 32	✓	◆	1/2" G	300	365	1	1	4932352085	4002395367399
35	WCHP-SB 35	✓	◆	1/2" G	300	365	1	1	4932352086	4002395367405
37	WCHP-SB 37	✓	◆	1/2" G	300	365	1	1	4932352087	4002395367412
40	WCHP-SB 40	✓	◆	1/2" G	300	365	1	1	4932352088	4002395367429
42	WCHP-SB 42	✓	◆	1/2" G	300	365	1	1	4932352089	4002395367436
45	WCHP-SB 45	✓	◆	1/2" G	300	365	1	1	4932352090	4002395367443
50	WCHP-SB 50	✓	◆	1/2" G	300	365	1	1	4932352092	4002395367467
52	WCHP 52		✓	1 1/4" UNC	420	500	1	1	4932399707	4002395363582
52	WCHP-SB 52	✓		1 1/4" UNC	420	500	1	1	4932352734	4002395373925
62	WCHP 62		✓	1 1/4" UNC	420	500	1	1	4932399708	4002395363599
62	WCHP-SB 62	✓		1 1/4" UNC	420	500	1	1	4932352735	4002395373932
72	WCHP 72		✓	1 1/4" UNC	420	500	1	1	4932399709	4002395363605
82	WCHP 82		✓	1 1/4" UNC	420	500	1	1	4932399710	4002395363612
82	WCHP-SB 82	✓		1 1/4" UNC	420	500	1	1	4932352736	4002395373949
92	WCHP 92		✓	1 1/4" UNC	420	500	1	1	4932399711	4002395363629
92	WCHP-SB 92	✓		1 1/4" UNC	420	500	1	1	4932352737	4002395373956
102	WCHP 102		✓	1 1/4" UNC	420	500	1	1	4932399712	4002395363636
102	WCHP-SB 102	✓		1 1/4" UNC	420	500	1	1	4932352738	4002395373963
112	WCHP 112		✓	1 1/4" UNC	420	500	1	1	4932399713	4002395363643
112	WCHP-SB 112	✓		1 1/4" UNC	420	500	1	1	4932352739	4002395373970
122	WCHP 122		✓	1 1/4" UNC	420	500	1	1	4932399714	4002395363650
122	WCHP-SB 122	✓		1 1/4" UNC	420	500	1	1	4932352740	4002395373987
132	WCHP 132		✓	1 1/4" UNC	420	500	1	1	4932399715	4002395363667
132	WCHP-SB 132	✓		1 1/4" UNC	420	500	1	1	4932352741	4002395373994
152	WCHP 152		✓	1 1/4" UNC	420	500	1	1	4932399716	4002395363674
152	WCHP-SB 152	✓		1 1/4" UNC	420	500	1	1	4932352742	4002395374007
162	WCHP 162		✓	1 1/4" UNC	420	500	1	1	4932399717	4002395363681
172	WCHP 172		✓	1 1/4" UNC	420	500	1	1	4932352052	4002395367092
182	WCHP 182		✓	1 1/4" UNC	420	500	1	1	4932399718	4002395363698
202	WCHP 202		✓	1 1/4" UNC	420	500	1	1	4932399719	4002395363704
225	WCHP 225		✓	1 1/4" UNC	420	500	1	1	4932399720	4002395363711
250	WCHP 250		✓	1 1/4" UNC	420	500	1	1	4932399721	4002395363728
300	WCHP 300		✓	1 1/4" UNC	420	500	1	1	4932399722	4002395363735
350	WCHP 350		✓	1 1/4" UNC	420	500	1	1	4932399723	4002395363742

✓ Most suitable

◆ Limited suitability

WCHP-SB
Ø 8–50 mm

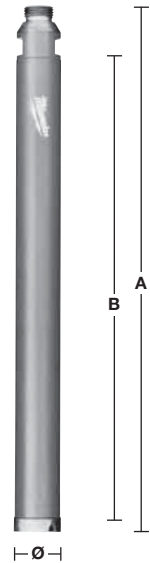

WCHP-SB
Ø 52–152 mm

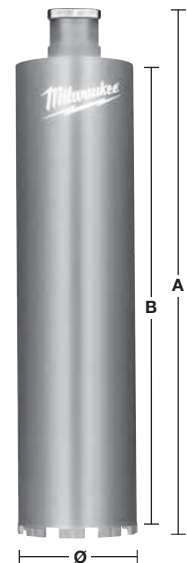

WCHP
Ø 52–350 mm

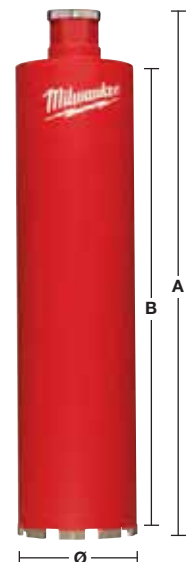

System attachments - wet diamond drilling

Description	Fits DD3-152	Fits DCM2-250C & DCM2-350C	Pack quantity	Min. order quantity	Article Number	EAN Code
Fixing kit. For exclusive use in concrete. Ø 16 mm drill bit is required to set the drop anchor.						
① Stud bolt, setting tool, wing nut, washer and 5 pcs M12" drop anchor.	✓	✓	9	1	4932399731	4002395363827
1 3/8" open ended spanner. For holding the motor output spindle while removing a core bit.		✓	1	1	49964705	04524222766
32 mm ended spanner. For holding the motor output spindle while removing a core bit.	✓		1	1	4931428009	4002395844791
41 mm open ended spanner. For removing the core bit from the motor spindle.	✓	✓	1	1	4931428010	4002395844807
Fixtec release. Suitable for all diamond motors with 1 1/4" spindle reception. Prevents the core bit from locking itself too tight onto the machine spindle. The core bits can then be released and removed with minimum effort.	✓	✓	1	1	4932352053	4002395367108
1 1/4" female to 1/2" female adaptor. To enable the connection of <50 mm diamond core bits on a 1 1/4" machine spindle thread.	✓	✓	1	1	4932352627	4002395372850
1 1/4" female / male extension rod, length 300 mm.	✓	✓	1	1	4932399724	4002395363759
1 1/4" female / male extension rod, length 500 mm.	✓	✓	1	1	4932399725	4002395363766
Telescopic extension. Extension pole used to fix drill rig to the ground instead of anchor bolts. Maximum load of 500 kg and adjustable extension height from 1.8-2.9 m.	✓	✓	1	1	4932399732	4002395363834
Vacuum pump VP6. For fastening of the diamond drill rig on smooth and even surfaces.						
⑤ Suction capacity: 850 mbar. Max. vacuum pressure: 6 m³/h / 100 l/min. Rated voltage: 220-240 V.	✓	✓	1	1	4932352094	4002395367474
⑥ Vacuum plate. Replacement rubber seal 4931428665.	✓		1	1	4932352676	4002395373345
WT 10 watertank. 10 liters capacity, steel, water tank with inside and outside polyester coating. Reliable brass pump with a max. pressure bar of 6 bar. 2.5 m hose with quick connection system fits direct to Milwaukee® diamond drills.	✓	✓	1	1	4932399726	4002395363773
⑧ Water collection ring. For use with drill rig DR 152 T. For use with max. Ø 152 mm core bits.			1	1	4932352677	4002395373352
Replacement rubber ring for DR 152 T.			1	1	4932352678	4002395373369
⑨ Water collection ring. For use with drill rig DR 250 TV. For use with max. Ø 180 mm core bits.			1	1	4932399727	4002395363780
Replacement rubber ring for DR 250 TV.			1	1	4932399729	4002395363803
⑨ Water collection ring. For use with drill rig DR 350 T. For use with max. Ø 300 mm core bits.			1	1	4932399728	4002395363797
Replacement rubber ring for DR 350 T.			1	1	4932399730	4002395363810
⑩ Spacer block T = 50 mm. Needs to be mouted between drill rig and motor cores > 250 mm and max. 350 mm. Included in drill rig DR 350 T.		✓	1	1	4932399736	4002395363872
Quick connection motor mounting plate. Included in both drill rigs DR 250 TV and DR 350 T.		✓	1	1	4932399733	4002395363841



FIXTEC Diamond Core System

The patented Milwaukee® range of FIXTEC diamond core adaptors allows changing diamond cores in a matter of seconds without the use of extra tools.

The most common complaint with existing systems is that the diamond core locks itself tight onto the machine making it increasingly difficult to later remove the core, even with the aid of spanners and wrenches. However with the new FIXTEC adaptor solution from Milwaukee® this is a problem of the past, the cores can be unscrewed, removed and exchanged quite simply by hand – there is no need for spanners or wrenches.

The revolutionary FIXTEC adaptors are available with or without dust absorption and with different tool receptions making them compatible to other manufacturers tools.

The Past



The Future



FIXTEC solution

FIXTEC solution with dust extraction

FIXTEC Clean Liner Rotor (CLR) Fits to diamond cores with 1 1/4" UNC thread. The added advantage of dust absorption allows drilling speed to be increased and extends the lifetime of the diamond cores.

Description	Tool reception	Core reception	Pack quantity	Min. order quantity	Article Number	EAN Code
② FIXTEC Clean Line Rotor (CLR).	M18 x 2.5	1 1/4" UNC	1	1	4932352172	4002395368242



FIXTEC solution without dust extraction

FIXTEC adaptor Fits to diamond cores with M16 thread. As centering drill bit a standard SDS-plus drill bit can be used.

Description	Tool reception	Core reception	Pack quantity	Min. order quantity	Article Number	EAN Code
FIXTEC adaptor. Tool changing in seconds. No extra tool required.	M18 x 2.5	M16	1	1	4932399174	4002395357819
	11 mm Hex	M16	1	1	4932399220	4002395358342



Dry diamond cores with dust extraction - DCHXL

- 10 mm high segments for longer life.
- Laser welded segments for extra durability.
- Use with the machine set to rotary only, not suitable for hammer action.
- During pre-drilling the centering unit (centering stars, guide rod and SDS Plus pilot drill bit) must be used.



Material	DCHXL	Material	DCHXL
Aerated/breeze concrete blocks	◆	Granite	✘
Artificial stone – hard	✘	Lime/sandstone – hard	✓
Brick – very hard, engineering brick	✓	Lime/sandstone – soft/abrasive	◆
Brick – medium	✓	Marble	✘
Brick – soft	◆	Tiles	✘
Concrete	✘		

✓ Most suitable. Recommended for these materials.
 ✘ Not suitable. Not recommended for these materials.

◆ Limited suitability – recommended for intermittent use.
 Very good in drilling characteristics, but reduced lifetime.

Descrip- tion	Diameter (mm)	Core reception	Working length (mm) B	Total length (mm) A	Pack quantity	Min. order quantity	Article Number	EAN Code
DCHXL 38*	38	1 1/4" UNC	420	490	1	1	4932399753	4002395364060
DCHXL 52	52	1 1/4" UNC	420	490	1	1	4932399163	4002395357703
DCHXL 68	68	1 1/4" UNC	420	490	1	1	4932399164	4002395357710
DCHXL 82	82	1 1/4" UNC	420	490	1	1	4932399165	4002395357727
DCHXL 102	102	1 1/4" UNC	420	490	1	1	4932399166	4002395357734
DCHXL 107	107	1 1/4" UNC	420	490	1	1	4932399754	4002395364077
① DCHXL 112	112	1 1/4" UNC	420	490	1	1	4932399167	4002395357741
DCHXL 117	117	1 1/4" UNC	420	490	1	1	4932399755	4002395364084
DCHXL 122	122	1 1/4" UNC	420	490	1	1	4932399168	4002395357758
DCHXL 127	127	1 1/4" UNC	420	490	1	1	4932399169	4002395357765
DCHXL 132	132	1 1/4" UNC	420	490	1	1	4932399170	4002395357772
DCHXL 152	152	1 1/4" UNC	420	490	1	1	4932399171	4002395357789
DCHXL 162	162	1 1/4" UNC	420	490	1	1	4932399172	4002395357796

* During pre-drilling no centering star required.

Description	Tool reception	Core reception	Pack quantity	Min. order quantity	Article Number	EAN Code
-------------	----------------	----------------	---------------	---------------------	----------------	----------

② FIXTEC Clean Line Rotor (CLR). M18 x 2.5 1 1/4" UNC 1 1 4932352172 4002395368242

Description	Pack quantity	Min. order quantity	Article Number	EAN Code
-------------	---------------	---------------------	----------------	----------

③ Guide rod for DD2-160. Supplied with locking screw (4931622432). Requires allen key (4931616044) and SDS-plus pilot drill bit (Ø 8 x 160 mm, 4932307071). 1 1 4932399173 4002395357802

④ Guide rod for DD3-152. Requires SDS-plus pilot drill bit (Ø 8 x 110 mm, 4932307070). 1 1 4932352679 4002395373376

Dia- meter (mm)	Article Number	EAN Code	Dia- meter (mm)	Article Number	EAN Code
52	4931393176	4002395358380	117	4931403508	4002395364107
68	4931393177	4002395358397	122	4931393181	4002395780709
82	4931393178	4002395358403	127	4931393182	4002395780716
⑤ 102	4931393179	4002395358410	132	4931393183	4002395358458
107	4931403507	4002395364091	152	4931393184	4002395358465
112	4931393180	4002395358427	162	4931393185	4002395358472

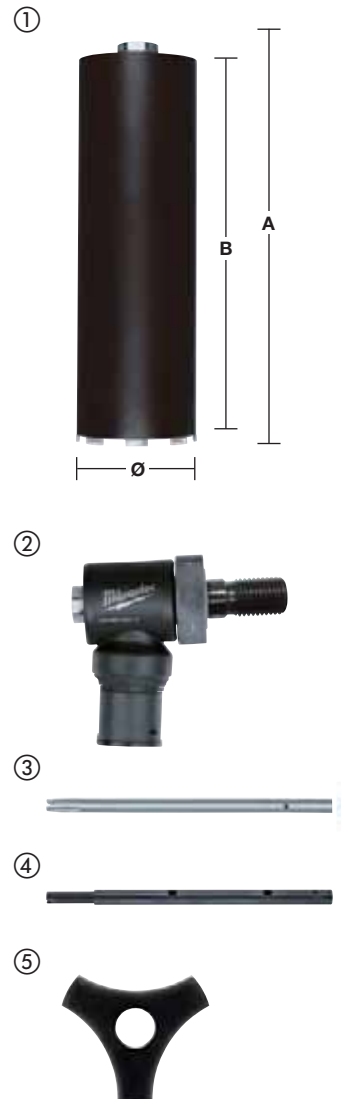

Dry diamond cores for electrical sockets with dust extraction - DCHX

- 10 mm high segments for longer life.
- Laser welded segments for extra durability.
- Suitable for installation of electrical sockets and junction boxes.
- Use with the machine set to rotary only, not suitable for hammer action.

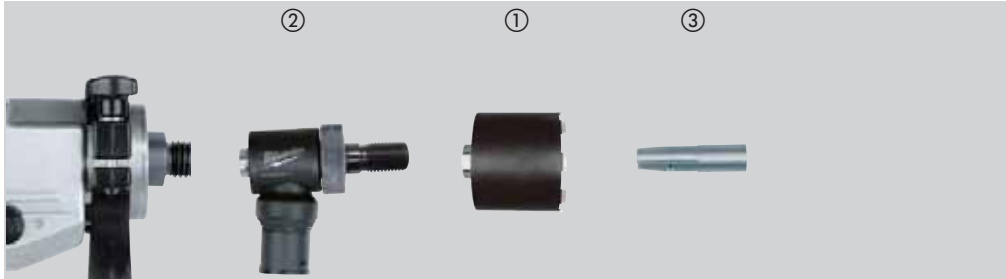

Material	DCHX	Material	DCHX
Aerated/breeze concrete blocks	◆	Granite	✘
Artificial stone – hard	✘	Lime/sandstone – hard	✓
Brick – very hard, engineering brick	✓	Lime/sandstone – soft/abrasive	◆
Brick – medium	✓	Marble	✘
Brick – soft	◆	Tiles	✘
Concrete	✘		

- ✓ Most suitable. Recommended for these materials.
- ◆ Limited suitability – recommended for intermittent use. Very good in drilling characteristics, but reduced lifetime.
- ✘ Not suitable. Not recommended for these materials.

	Description	Diameter (mm)	Core reception	Working length (mm) B	Total length (mm) A	Pack quantity	Min. order quantity	Article Number	EAN Code
①	DCHX 68	68	1 1/4" UNC	60	130	1	1	4932399217	4002395358311
	DCHX 82	82	1 1/4" UNC	60	130	1	1	4932399218	4002395358328

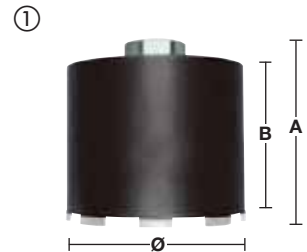

	Description	Tool reception	Core reception	Pack quantity	Min. order quantity	Article Number	EAN Code
②	FIXTEC Clean Line Rotor (CLR).	M18 x 2.5	1 1/4" UNC	1	1	4932352172	4002395368242



	Description	Pack quantity	Min. order quantity	Article Number	EAN Code
③	Guide rod for DD2-160. Supplied with locking screw (4931622432). Requires allen key (4931616044) and SDS-plus pilot drill bit (8 x 110 mm, 4932307070).	1	1	4932399221	4002395358359
	Guide rod for DD3-152. Requires SDS-plus pilot drill bit (8 x 110 mm, 4932307070).	1	1	4932352680	4002395373383



Dry diamond drilling for electrical sockets without dust extraction - DCU / DCH

- 7 mm high segments.
- Laser welded segments for extra durability.
- Suitable for installation of electrical sockets and junction boxes.
- Use with the machine set to rotary only, not suitable for hammer action.

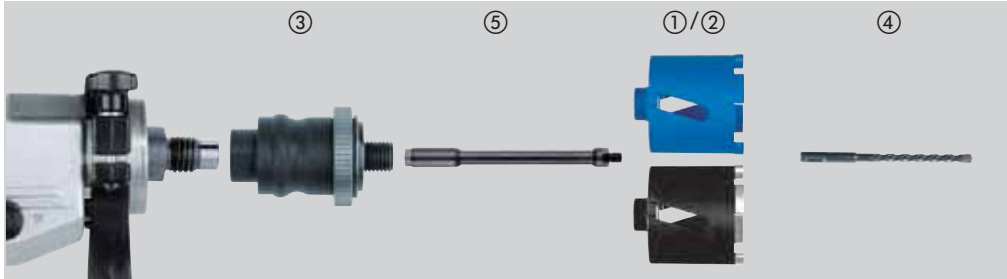

Material	DCU	DCH	Material	DCU	DCH
Aerated/breeze concrete blocks	◆	◆	Granite	✗	✗
Artificial stone – hard	✗	✗	Lime/sandstone – hard	◆	✓
Brick – very hard, engineering brick	◆	✓	Lime/sandstone – soft/abrasive	✓	◆
Brick – medium	✓	✓	Marble	✗	✗
Brick – soft	✓	◆	Tiles	✗	✗
Concrete	✗	✗			

- ✓ Most suitable. Recommended for these materials.
- ◆ Limited suitability – recommended for intermittent use. Very good in drilling characteristics, but reduced lifetime.
- ✗ Not suitable. Not recommended for these materials.

- ✓ Most suitable. Recommended for these materials.
- ◆ Limited suitability – recommended for intermittent use. Very good in drilling characteristics, but reduced lifetime.
- ✗ Not suitable. Not recommended for these materials.

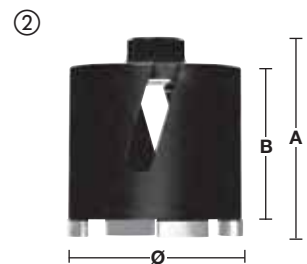
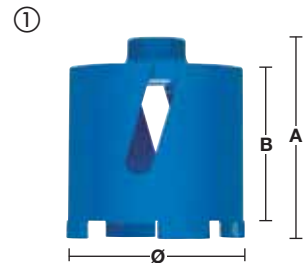

Descrip- tion	Diameter (mm)	Core reception	Working length (mm) B	Total length (mm) A	Pack quantity	Min. order quantity	Article Number	EAN Code
① DCU 68	68	M16	60	90	1	1	4932371978	4002395346035
① DCU 82	82	M16	60	90	1	1	4932371979	4002395346042
② DCH 68	68	M16	60	90	1	1	4932399579	4002395362080
② DCH 82	82	M16	60	90	1	1	4932399580	4002395362097

Description	Tool reception	Core reception	Pack quantity	Min. order quantity	Article Number	EAN Code
③ FIXTEC adaptor. Tool changing in seconds. No extra tool required.	M18 x 2.5	M16	1	1	4932399174	4002395357819
	11 mm Hex	M16	1	1	4932399220	4002395358342
④ Requires SDS-plus pilot drill bit (Ø 8 x 160 mm).			1	1	4932307071	4002395308873

Description	Adaptor reception	Core reception	Total length (mm) A	Pack quantity	Min. order quantity	Article Number	EAN Code
⑤ Extention between FIXTEC adaptor and diamond core.	M16	M16	300	1	1	4932369736	4002395346028



Dry diamond drilling without dust extraction - DCH 150

- 10 mm high segments.
- Laser welded segments for extra durability.
- Use with the machine set to rotary only, not suitable for hammer action.

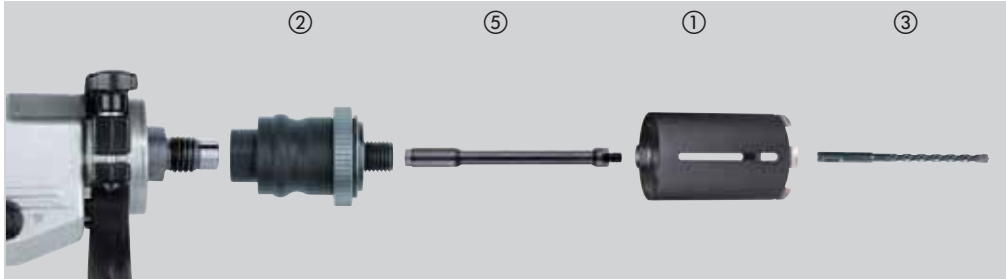

Material	DCH	Material	DCH
Aerated/breeze concrete blocks	◆	Granite	✘
Artificial stone – hard	✘	Lime/sandstone – hard	✓
Brick – very hard, engineering brick	✓	Lime/sandstone – soft/abrasive	◆
Brick – medium	✓	Marble	✘
Brick – soft	◆	Tiles	✘
Concrete	✘		

- ✓ Most suitable. Recommended for these materials.
- ◆ Limited suitability – recommended for intermittent use. Very good in drilling characteristics, but reduced lifetime.
- ✘ Not suitable. Not recommended for these materials.

- ✓ Most suitable. Recommended for these materials.
- ◆ Limited suitability – recommended for intermittent use. Very good in drilling characteristics, but reduced lifetime.
- ✘ Not suitable. Not recommended for these materials.

Description	Diameter (mm)	Core reception	Working length (mm) B	Total length (mm) A	Pack quantity	Min. order quantity	Article Number	EAN Code
DCH 150-52	52	M16	150	180	1	1	4932352628	4002395372867
DCH 150-62	62	M16	150	180	1	1	4932352629	4002395372874
DCH 150-68	68	M16	150	180	1	1	4932352630	4002395372881
DCH 150-82	82	M16	150	180	1	1	4932352631	4002395372898
DCH 150-102	102	M16	150	180	1	1	4932352632	4002395372904
DCH 150-127	127	M16	150	180	1	1	4932352633	4002395372911



Description	Tool reception	Core reception	Pack quantity	Min. order quantity	Article Number	EAN Code
FIXTEC adaptor. Tool changing in seconds. No extra tool required.	M18 x 2.5	M16	1	1	4932399174	4002395357819
	11 mm Hex	M16	1	1	4932399220	4002395358342



③ Requires SDS-plus pilot drill bit (Ø 8 x 260 mm). 1 1 4932353821 4002395320141

Description	Adaptor reception	Core reception	Total length (mm) A	Pack quantity	Min. order quantity	Article Number	EAN Code
Extension between FIXTEC adaptor and diamond core.	M16	M16	300	1	1	4932369736	4002395346028

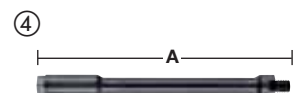

SPEEDCROSS

MILWAUKEE® SPEEDCROSS DIAMOND BLADES ARE ENGINEERED FOR ALL CONSTRUCTION SITE PROFESSIONALS WHO DEMAND ONLY THE BEST IN PERFORMANCE WHEN WORKING IN THE TOUGHEST ENVIRONMENTS.



Segments

10 mm segment height to ensure long lifetime. High diamond concentration with special aggressive geometry gives a high cutting performance. Laser welded segments for 100% user safety.

Precision engineered blade body

Pre-tensioned and hardened blade body for perfect concentration and maximum resistance to heat build up.

Cool cutting slots

The slots and holes improve the airflow keeping the cutting temperature of the segments to a minimum. This safeguards the segments from heat damage and allows the user to cut more and quicker.

Noise reduction qualities

Perfect balance and concentration suppress cutting noise.

Low vibration

The tensioned blade body eliminates wobble and minimises vibration.

Laser marked

All technical/safety information plus the direction of rotation arrow is laser marked for the complete life of the blade. Even when used in abrasive materials the information will not wear off.

**DIAMOND PREMIUM BLADES
MAXIMUM SPEED!**

Speedcross Blades

SPEEDCROSS

**MAXIMUM SPEED,
LONG LIFE,
LOW VIBRATION!**

- Universal blades for a variety of materials
- Classed into two categories for maximum lifetime
- 10 mm segments height to ensure long lifetime
- Laser welded segments for best performance
- Low vibration



**HUDD
HARD UNIVERSAL**



**AUDD
ABRASIVE UNIVERSAL**

Application areas

The Speedcross blades are both universal in application but their best performance is achieved at different ends of the spectrum. The HUDD is predominantly a blade for very hard to medium hard general building materials, the harder the material the better the performance. Alternatively the AUDD is most suitable for hard materials to soft/abrasive materials, its best performance is achieved when used in standard hardness concrete and general building materials.

Hard materials

Soft/Abrasive materials

Natural stone / granite	Hard concrete	Medium strength concrete	General building materials	Brick	Soft / green concrete	Asphalt

HUDD AUDD

Speedcross HUDD

Type	Disc diameter (mm)	Bore size (mm)	Segment height (mm)	Cutting width (mm)	Pack quantity	Min. order quantity	Article Number	EAN Code
HUDD 115	115	22.23	10	2.6	1	1	4932399819	4002395364749
HUDD 125	125	22.23	10	2.6	1	1	4932399820	4002395364756
HUDD 150	150	22.23	10	2.6	1	1	4932399821	4002395364763
HUDD 230	230	22.23	10	2.6	1	1	4932399822	4002395364770



Speedcross AUDD

Type	Disc diameter (mm)	Bore size (mm)	Segment height (mm)	Cutting width (mm)	Pack quantity	Min. order quantity	Article Number	EAN Code
AUDD 115	115	22.23	10	2.6	1	1	4932399823	4002395364787
AUDD 125	125	22.23	10	2.6	1	1	4932399824	4002395364794
AUDD 150	150	22.23	10	2.6	1	1	4932399825	4002395364800
AUDD 230	230	22.23	10	2.6	1	1	4932399826	4002395364817



Diamond blades

Diamond blades DU

A general purpose blade offering good performance in speed and lifetime in a wide variety of construction materials.

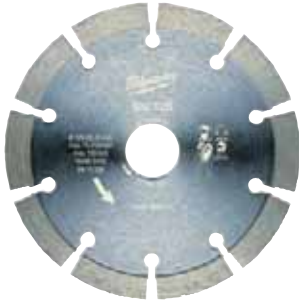

Type	Disc diameter (mm)	Bore size (mm)	Segment height (mm)	Cutting width (mm)	Pack quantity	Min. order quantity	Article Number	EAN Code
DU 115	115	22.23	10	2.2	1	1	4932399521	4002395361687
DU 125	125	22.23	10	2.3	1	1	4932399522	4002395361694
DU 180	180	22.23	10	2.4	1	1	4932399523	4002395361700
DU 230	230	22.23	10	2.6	1	1	4932399524	4002395361717

Diamond blades DUT

A general purpose turbo rimmed blade for cutting a wide variety of general building materials. The turbo rim ensures clean chip free cuts.



Type	Disc diameter (mm)	Bore size (mm)	Segment height (mm)	Cutting width (mm)	Pack quantity	Min. order quantity	Article Number	EAN Code
DUT 115	115	22.23	10	2.2	1	1	4932399526	4002395361731
DUT 125	125	22.23	10	2.3	1	1	4932399527	4002395361748
DUT 180	180	22.23	10	2.4	1	1	4932399528	4002395361755
DUT 230	230	22.23	10	2.6	1	1	4932399529	4002395361762

Diamond blades

Diamond blades DUH

A trade laser welded quality blade with exceptional performance in hard materials such as hard concrete, block paviors and masonry products.



Type	Disc diameter (mm)	Bore size (mm)	Segment height (mm)	Cutting width (mm)	Pack quantity	Min. order quantity	Article Number	EAN Code
DUH 115	115	22.23	10	2.2	1	1	4932399539	4002395361861
DUH 125	125	22.23	10	2.3	1	1	4932399540	4002395361878
DUH 180	180	22.23	10	2.4	1	1	4932399541	4002395361885
DUH 230	230	22.23	10	2.6	1	1	4932399542	4002395361892

Diamond blades DHTS

A trade quality turbo blade with extra thin body (DHTS 115 = 1.7 mm, DHTS 125 / DHTS 230 = 1.8 mm) for very fast, precise and chip free cuts in thin materials such as granite, marble slabs and tiles (type: porcelain, gres, ceramic).

Due to the high quality of this blade it is also suitable for cutting most building materials.



Type	Disc diameter (mm)	Bore size (mm)	Segment height (mm)	Cutting width (mm)	Pack quantity	Min. order quantity	Article Number	EAN Code
DHTS 115	115	22.23	10	1.2	1	1	4932399145	4002395357550
DHTS 125	125	22.23	10	1.2	1	1	4932399146	4002395357567
DHTS 230	230	22.23	10	1.9	1	1	4932399550	4002395361977

Diamond blades DHTi

Specifically designed turbo rimmed blade for clean cut edges in ceramic tiles and thin natural stone tiles / slabs.



Type	Disc diameter (mm)	Bore size (mm)	Segment height (mm)	Cutting width (mm)	Pack quantity	Min. order quantity	Article Number	EAN Code
DHTi 115	115	22.23	8	2.0	1	1	4932399552	4002395361991
DHTi 125	125	22.23	8	2.1	1	1	4932399553	4002395362004
DHTi 230	230	22.23	8	2.6	1	1	4932399555	4002395362028

Diamond blades DSU

A trade quality universal blade, specially designed for hard and abrasive materials.

Laser welded segments provide long lifetime and excellent cutting performance. Recommended for use with wall chasers.



Type	Disc diameter (mm)	Bore size (mm)	Segment height (mm)	Cutting width (mm)	Pack quantity	Min. order quantity	Article Number	EAN Code
DSU 125	125	22.23	10	2.4	1	1	4932373147	4002395346455
DSU 150	150	22.23	10	2.4	1	1	4932373148	4002395346462

Diamond blades: Which diamond cutting blade for which material?

Material	Type	Speedcross Premium		Professional					
		HUDD	AUDD	DU	DUT	DUH	DHTS	DHTi	DSU
Abrasive refractory materials		◆	✓						
Aerated concrete/breeze blocks		◆	✓	✓	✓	✓			◆
Artificial stone		✓			✓	✓			✓
Artificial stone – hard		✓				✓	✓	◆	✓
Asphalt			◆						
Basalt		✓	✓		✓	✓			✓
Brick – very hard, engineering brick		✓			◆	✓			✓
Brick – medium to hard		✓		◆	◆	✓			✓
Brick – medium to soft		✓	✓	◆	◆	◆			✓
Concrete – hard		✓	◆			✓			✓
Concrete – medium		✓	✓	✓	✓	✓			✓
Concrete – soft/green		◆	✓						◆
Concrete with flint aggregate		◆	✓						
Concrete with flint and rebar		◆	✓						
Concrete kerbstones		✓	✓			✓			✓
Concrete lintels		✓	◆			✓			✓
Concrete block paviors		✓	✓	◆	◆	✓			✓
Concrete tiles		✓	✓	✓	✓	✓	◆		✓
Concrete reinforced with rebar		✓	◆	◆	◆	✓			✓
Concrete slabs		✓	◆			✓			✓
Concrete slabs with aggregate		✓	✓		◆	✓			✓
Fireclay		✓	✓			✓			✓
General building materials		✓	✓	✓	✓	✓			✓
Gneiss		✓				◆			◆
Granite		✓			✓	✓			✓
Granite tiles/slabs		◆			✓	◆	✓		◆
Lime/sandstone blocks – hard		✓	✓			✓			✓
Lime/sandstone blocks – medium		✓	✓	◆	◆	✓			
Lime/sandstone – soft/abrasive		◆	✓	◆	◆	◆			◆
Marble tiles/slabs		◆			✓	◆	✓	◆	✓
Metal channel/profiles							◆		
Poroton		✓	✓	✓	✓	✓			✓
Porphyry		✓			◆	✓	✓		✓
Roof tiles – clay		✓	◆	◆	✓	◆	✓		✓
Roof tiles – concrete		✓	✓		✓	◆	✓		✓
Screed		◆	✓	◆	◆	◆			◆
Slate		✓	◆	◆	✓	✓	✓		◆
Stoneware/clay tiles		✓	✓		✓	✓			✓
Tiles – ceramic					◆		✓	✓	
Tiles – porcelain and gres type					◆		✓	◆	
Tiles – terrazo type		✓	◆		✓	✓	✓		✓

✓ Most suitable. Recommended for these materials. Very long service life and very good cutting characteristics.

◆ Suitable. Recommended for intermittent use in these materials. Good service life and cutting characteristics.

Combi-segment diamond cup wheels

All rounder in applications:

For quick grinding down of thick concrete layers.

For levelling of concrete, granite and natural stone surfaces.

For edge grinding applications e.g. grinding off high edges of concrete, granite, natural stone tiles.

For roughening prior to covering with a new layer of coating.

High quality diamonds and special soft bonding for low wear, especially in hard materials.

Large openings for better dust removal and segment cooling.

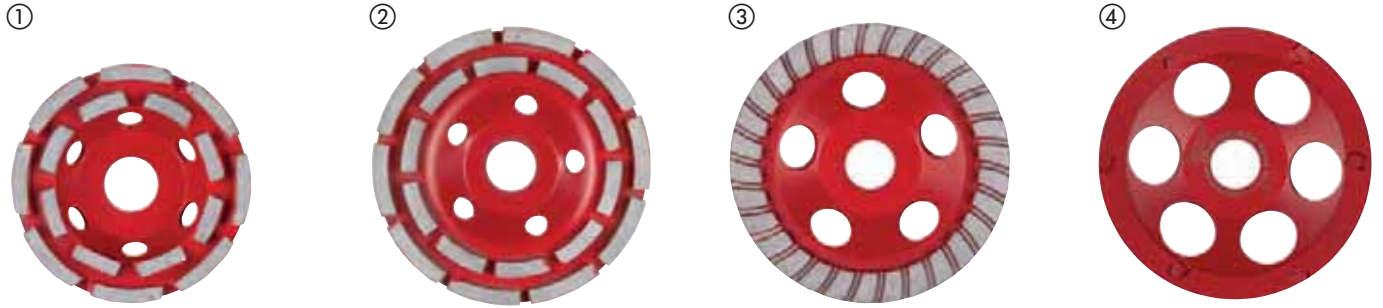

Type	Diameter (mm)	Bore size (mm)	No. of segments	Cup wheel height [mm]	Segment height (mm)	Pack quantity	Min. order quantity	Article Number	EAN Code
DCWU 100									
① Universal wheel for grinding and levelling applications. High stock removal.	100	22.23	16	21	5	1	1	4932451185	4002395138739
DCWU 125									
② Universal wheel for grinding and levelling applications. High stock removal.	125	22.23	20	21	5	1	1	4932451186	4002395138746
DCWUT 125									
③ Turbo type segment for levelling, edge grinding and for smooth finishing. Fine finish for concrete and natural stone.	125	22.23	Turbo	21	5	1	1	4932451187	4002395138753
DCWS 125									
④ PCD segment for removal of special substances: thermoplastic and epoxy based coatings, acrylic paint, glue, tile adhesive, screed, plaster.	125	22.23	6	18.5	4 / 7	1	1	4932451188	4002395138760

	DCWU 100	DCWU 125	DCWUT 125	DCWS 125
Acrylic paint and coatings				✓
Aerated and breeze concrete blocks	✓	✓	✓	
Bitumen				✓
Concrete hard	✓	✓	✓	
Concrete soft or green	◆	◆	◆	
Epoxy resin coatings and glues				✓
Granite	◆	◆	◆	
Lime and sandstone blocks hard	✓	✓	✓	
Lime and sandstone blocks soft and abrasive	◆	◆	◆	◆
Marble	◆	◆	◆	
Plasterboard	◆	◆	◆	
Porphyry	◆	◆	◆	
Screed	◆	◆	◆	
Thermoplastic protective paint, glue				✓
Tile adhesive	◆	◆	◆	✓

✓ Most suitable.

◆ Suitable - for intermittent use.

System accessories - Wall chasers

AUDD blade is a perfect solution for 80% of wall chaser applications.

- 30% less loading on the machine compared to the Milwaukee® DU blade.
- 40% higher speed of cut compared to the Milwaukee® DU blade.

SPEEDCROSS

	① HUDD	② AUDD	③ DSU
Abrasive refractory materials	◆	✓	
Aerated and breeze concrete blocks	◆	✓	◆
Brick medium to soft	✓	✓	✓
Concrete medium	✓	✓	✓
Concrete reinforced with rebar	✓	◆	✓
Concrete with flint and rebar	◆	✓	
Fireclay	✓	✓	✓
General building materials	✓	✓	✓
Granite	✓		✓
Lime and sandstone blocks soft and abrasive	◆	✓	◆
Lime and sandstone blocks medium	✓	✓	
Screed	◆	✓	◆

✓ Maximum performance ◆ Limited suitability - recommended for intermittent use





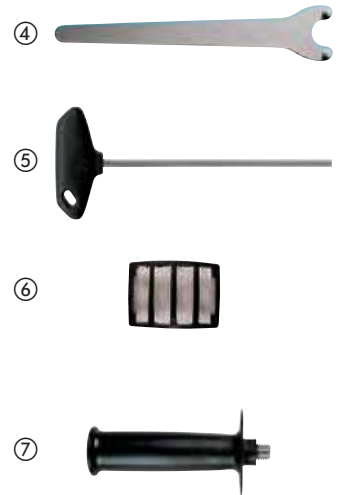

Description	Fits wall chasers	Pack quantity	Min. order quantity	Article Number	EAN Code
Transport case for wall chasers.	MFE 1500, MFE 1305, MF 1900	WCE 30, WCS 45, DME 30, DME 45	1	1	4932383357 4002395357390
④ Pin spanner.	MFE 1500, MFE 1305, MF 1900	DME 30, DME 45, WCS 45, DME 65, WCE 65, WCE 30	1	1	4932367712 4002395338467
⑤ T-handle key.	MFE 1500, MFE 1305, MF 1900	WCE 30, WCS 45, WCE 65, DME 30, DME 45, DME 65	1	1	4931362928 4002395661879
Dust protection grille against entry of ground particles.	MFE 1500, MFE 1305, MF 1900	WCE 30, WCS 45, DME 30, DME 45	1	1	4932329397 4002395303892
⑥ Dust protection grille against entry of ground particles.		WCE 65, DME 65	2	1	4932326525 4002395303311
Extension hose Ø 35 mm / 4 m long. Requires adaptor (362778).	MFE 1500, MFE 1305, MF 1900	DME 30, WCE 30, DME 45, WCS 45, DME 65, WCE 65	1	1	4932330552 4002395312719
Adaptor with bayonet fitting for direct connection of hose to machine.	MFE 1500, MFE 1305, MF 1900	WCE 30, WCS 45, WCE 65, DME 30, DME 45, DME 65	1	1	4932362778 4002395334285
⑦ Side handle	MFE 1500, MFE 1305, MF 1900	WCE 30, WCS 45, DME 30, DME 45	1	1	4932409546 4002395370870
Flange nut.	MFE 1305	DME 1300	1	1	4932334667 4002395304448
Clamping flange.	MFE 1305	DME 1300	1	1	4932334706 4002395304455
Spacer set. Contents 6 rings.	MFE 1305		6	1	4931334675 4002395762804
Spacer set.		DME 30, DME 45, DME 65, WCE 30, WCE 65	5	1	4931362797 4002395764068



Cutting and grinding discs

Milwaukee® Type - how to find the right disc

SC 41 / 115					
Material	Application	Design	Diameter		
S = Steel	C = Cutting	 flat 41	mm	inches	
C = Stone	G = Grinding	 depressed 42	100	4	
	CS = Cutting Slim	 depressed 27	115	4½	
	L = Flap	 flap 50	125	5	
	LC = Flap Ceramic		150	6	
	CT = Cutting Thin		180	7	
			230	9	
			355	14	



Extended life and moisture protection with PRO+**

■ **Special mixture delivers:**

- Up to 20% longer lifetime vs. Milwaukee® contractor series.
- Up to 20% less dust development vs. Milwaukee® contractor series.
- The new formula HydroProtect prevents the age-related loss of performance and still provides almost the entire performance after months of storage.

■ **Benefits:**

- Reduced costs per cut and shorter set up times.
- Reduction of wheel deterioration during the storage interval.
- Longer lasting high-performance.



*vs. Milwaukee® contractor series



**available on cutting and grinding discs with thickness 1, 1.5, 1.9 and 6 mm.

Thin metal cutting discs PRO+

Applications: Iron and sulphur free top line thin cut-off wheels for all steels. Best suitable for stainless and acid-resistant steel, hardox, heat-resistant cast steel, spring steel, mild and tool steel.

Characteristics: 50% less cutting time and 50% less dust than standard 3 mm thick discs. Lower material loss.



Type	Disc diameter (mm)	Thickness (mm)	Bore size (mm)	Pack quantity	Min. order quantity	Article Number	EAN Code
41	SCS 41 / 115	115	1	22.2	1	50	4932451484 4002395163953
	① Counter display (200 x SCS 41 / 115 discs).			200	1	4932451485	4002395163960
	SCS 41 / 115	115	1.5	22.2	1	50	4932451486 4002395163977
	SCS 41 / 125	125	1	22.2	1	50	4932451487 4002395163984
	① Counter display (200 x SCS 41 / 125 discs).			200	1	4932451488	4002395163991
	SCS 41 / 180	180	1.5	22.2	1	25	4932451489 4002395161300
	SCS 41 / 230	230	1.9	22.2	1	25	4932451490 4002395161317

*Orders are only possible in master cartons. Order quantities greater than the pack quantity are to be ordered in multiples (i.e. 50, 100, 150...)

Metal cutting discs PRO+

Applications: Great performance in cutting mild steel with medium strength, plain alloy tool steel, concrete reinforcing iron and steel rebar.

Characteristics: Efficient cutting properties in combination with high performance.

Type	Disc diameter (mm)	Thickness (mm)	Bore size (mm)	Pack quantity	Min. order quantity	Article Number	EAN Code
41	SC 41 / 115	115	3	22.2	1	25	4932451491 4002395161324
	SC 41 / 125	125	3	22.2	1	25	4932451492 4002395161331
	SC 41 / 180	180	3	22.2	1	25	4932451493 4002395161348
	SC 41 / 230	230	3	22.2	1	25	4932451494 4002395161362
42	SC 42 / 115	115	3	22.2	1	25	4932451495 4002395161379
	SC 42 / 125	125	3	22.2	1	25	4932451496 4002395161393
	SC 42 / 180	180	3	22.2	1	25	4932451497 4002395162000
	SC 42 / 230	230	3	22.2	1	25	4932451498 4002395162017

*Orders are only possible in master cartons. Order quantities greater than the pack quantity are to be ordered in multiples (i.e. 50, 100, 150...)

Metal cutting discs for chop saws PRO+

Applications: For structural steels, tool steel, cast iron, hard high-grade steels and concrete reinforcing steel bars (rebar).
 Characteristics: Soft cutting wheel for chop saws.

Type	Disc diameter (mm)	Thickness (mm)	Bore size (mm)	Pack quantity	Min. order quantity	Article Number	EAN Code
41 SC 41 / 355	355	2.5	25.4	1	10	4932451505	4002395162086

*Orders are only possible in master cartons. Order quantities greater than the pack quantity are to be ordered in multiples (i.e. 50, 100, 150...)

Metal grinding discs PRO+

Applications: Sound performance in mild steel and non alloy tool steel.
 Characteristics: Provides good lifetime and efficient grinding characteristics.

Type	Disc diameter (mm)	Thickness (mm)	Bore size (mm)	Pack quantity	Min. order quantity	Article Number	EAN Code
27 SG 27 / 115	115	6	22.2	1	25	4932451501	4002395162048
SG 27 / 125	125	6	22.2	1	25	4932451502	4002395162055
SG 27 / 180	180	6	22.2	1	10	4932451503	4002395162062
SG 27 / 230	230	6	22.2	1	10	4932451504	4002395162079

*Orders are only possible in master cartons. Order quantities greater than the pack quantity are to be ordered in multiples (i.e. 50, 100, 150...)

Stone cutting discs PRO+

Applications: for concrete, masonry products and thin natural stone tiles.

Type	Diameter (mm)	Thickness (mm)	Bore size (mm)	Pack quantity	Min. order quantity	Article Number	EAN Code
42 CC 42 / 115	115	3	22.2	1	25	4932451499	4002395162024
CC 42 / 230	230	3	22.2	1	25	4932451500	4002395162031

*Orders are only possible in master cartons. Order quantities greater than the pack quantity are to be ordered in multiples (i.e. 50, 100, 150...)

Thin metal cutting discs Contractor series

Applications: Iron and sulphur free thin cut-off wheels for steel.
 Suitable for acid-resistant steel, hardox, high-alloy steel, mild and tool steel. Not suitable for stainless steel.

Type	Diameter (mm)	Thickness (mm)	Bore size (mm)	Pack quantity	Min. order quantity	Article Number	EAN Code
41 SCS 41 / 115	115	1	22.2	1	50	4932451474	4002395163250
Counter display (200 x SCS 41 / 115 discs)				200	1	4932451475	4002395163267
SCS 41 / 115	115	1.5	22.2	1	50	4932451476	4002395163274
SCS 41 / 125	125	1	22.2	1	50	4932451477	4002395163281
Counter display (200 x SCS 41 / 125 discs)				200	1	4932451478	4002395163298
SCS 41 / 125	125	1.5	22.2	1	25	4932451479	4002395163908
SCS 41 / 230	230	1.9	22.2	1	25	4932451480	4002395163915

*Orders are only possible in master cartons. Order quantities greater than the pack quantity are to be ordered in multiples (i.e. 50, 100, 150...)

Metal grinding discs Contractor series

Applications: suitable for mild steel. Not suitable for stainless steel.

Type	Diameter (mm)	Thickness (mm)	Bore size (mm)	Pack quantity	Min. order quantity	Article Number	EAN Code
27 SG 27 / 115	115	6	22.2	1	25	4932451481	4002395163922
SG 27 / 125	125	6	22.2	1	25	4932451482	4002395163939
SG 27 / 230	230	6	22.2	1	10	4932451483	4002395163946

*Orders are only possible in master cartons. Order quantities greater than the pack quantity are to be ordered in multiples (i.e. 50, 100, 150...)

Flap discs



- Maximum productivity with CERA TURBO™ 50% faster material removal 2x longer lifetime.
- Ceramic hybrid disc: grinds steel, stainless steel, bronze, titanium, aluminium.
- Ceramic grain: grinds and finishes in one step! Material removal like grit 40, finishing result like grit 60!
- Self trimming backing pad: allows grinding to the last grain!
- Natural fibre backing pad: low vibration & noise, no harmful dust.
- Highly flexible: perfectly adjusts to working piece.
- Low heat development: no metal discolouration, especially on stainless steel.
- Made in Germany.
- Ideal grinding speed: Ø115 mm: 7.000 - 8.000 rpm. Ø125 mm: 6.000 - 7.000 rpm.
- Applications: Ferrous metals, non-ferrous metals (aluminium, titan, etc.), stainless steel V2A (1.4301) / V4A (1.4401).

	Type	Disc diameter (mm)	Grit	Bore size (mm)	Backing pad material	Pack quantity	Min. order quantity	Article Number	EAN Code
50	SLC 50 / 115	115	Multigrain 40/60	22.2	Natural fibre	1	10	4932430407	4002395380688
	SLC 50 / 125	125	Multigrain 40/60	22.2	Natural Fibre	1	10	4932430408	4002395380695

Orders are only possible in master cartons (with 10 x 4932430407). Minimum order quantity is 10 x 4932430407 (= 1 master carton). Order quantities greater than 10 pcs are to be ordered in multiples of 10 pcs (ie. 20, 30, 40, 50 ...).

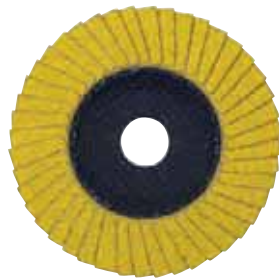

- High quality zirconium grain: longer lifetime on ferrous metals and stainless steel.
- Self trimming backing pad: allows grinding on the last grain!
- Natural fibre backing pad: low vibration & noise, no harmful dust.
- Highly flexible: perfectly adjusts to working piece.
- Low heat development: no metal discolouration, especially on stainless steel.
- Made in Germany
- Ideal grinding speed: Ø115 mm: 7.000 - 8.000 rpm. Ø125 mm: 6.000 - 7.000 rpm.
- Applications: Ferrous metals, stainless steel V2A (1.4301) / V4A (1.4401).

	Type	Disc diameter (mm)	Grit	Bore size (mm)	Backing pad material	Pack quantity	Min. order quantity	Article Number	EAN Code
50	SL 50 / 115	115	80	22.2	Natural Fibre	1	10	4932430412	4002395380732
	SL 50 / 115	115	120	22.2	Natural Fibre	1	10	4932430413	4002395380749
	SL 50 / 125	125	80	22.2	Natural Fibre	1	10	4932430414	4002395380756
	SL 50 / 125	125	120	22.2	Natural Fibre	1	10	4932430415	4002395380763

Orders are only possible in master cartons (with 10 x 4932430412). Minimum order quantity is 10 x 4932430412 (= 1 master carton). Order quantities greater than 10 pcs are to be ordered in multiples of 10 pcs (ie. 20, 30, 40, 50...).



FIXTEC Nut

- **FIXTEC:** Disc changing in seconds, no extra tools required.
- 12 seconds from removing the worn disc to fixing a new disc.
- Only 8 mm thin, enabling more surface of disc on the material.
- Compatible to all manufacturers angle grinders up to Ø 150 mm with standard M14 spindle thread.
- With integrated keyholes, for removal of the nut with a standard pin spanner in the event of the nut becoming too tight.



Description	Pack quantity	Min. order quantity	Article Number	EAN Code
FIXTEC nut - M14 thread. Counter display	1	12	4932352473	4002395371327



System attachments - Angle grinders

Description	Fits 115 mm angle grinders	Fits 125 mm angle grinders	Fits 150mm angle grinders	Fits 180mm angle grinders	Fits 230mm angle grinders	Pack quantity	Min. order quantity	Article Number	EAN Code
① Flange nut M14. Flange nut only for use on AG 25-230 Q.	✓	✓	✓	✓	✓	1	1	4932345628 49050091	4002395313105 045242174102
② Backing flange.	✓	✓	✓	✓	✓	1	1	4932263299	4002395307708
③ Two hole spanner straight.	✓	✓	✓	✓	✓	1	1	4932367712	4002395338467
④ Open-ended spanner. SW 17/24.	✓	✓	✓	✓	✓	1	1	4932345710	4002395307722
⑤ Cranked two hole spanner for steel wire brushes.				✓	✓	1	1	4932371469	4002395342181
⑥ Dust protection grille against entry of ground particles.		✓	✓			1	1	4932329397	4002395303892
				✓	✓	2	1	4932326525	4002395303311
Side handle	✓	✓	✓			1	1	4932409546	4002395370870
⑦ Anti-Vibration side handle.				✓	✓	1	1	4931433531	4002395889259
	✓	✓	✓	✓ ¹	✓	1	1	4932399991 4932399992	4002395366507 4002395366514
Hand protection guard.						1	1	4932378478	4002395347353
Flange nut set. Only for AGV 16- 180 Suitable for WS 2300 (Australia version)						3	1	4932351632	4002395321636
Flange nut M14 (4932345629), backing flange (4932371404), large flange nut (4932367952).									

¹ Only for AGV 16-180 QXC.

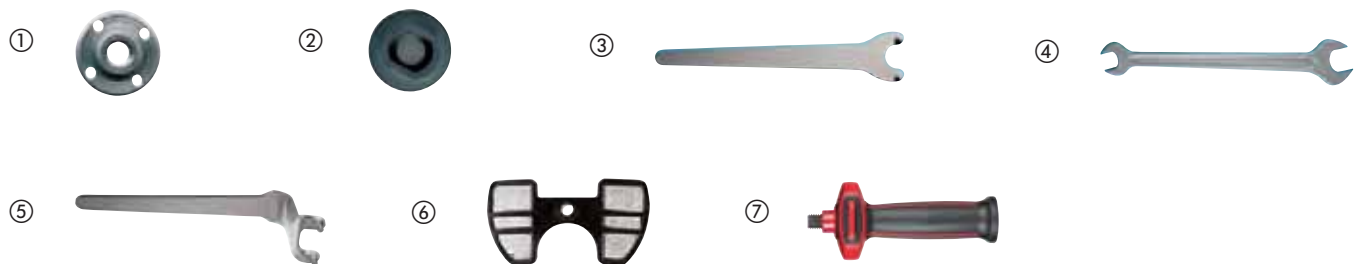

Flexible backing pads

Description	Bore size (mm)	Diameter (mm)	Fits 115 mm angle grinders	Fits 125 mm angle grinders	Fits 180mm angle grinders	Fits 230mm angle grinders	Pack quantity	Min. order quantity	Article Number	EAN Code
Flexible backing pad. Complete with flange nut M14 for all angle grinders.	14.2	110	✓				1	1	4932345760	4002395313488
	14.2	125		✓			1	1	4932345761	4002395313495
	14.2	170			✓		1	1	4932345758	4002395313501
	22.2	170			✓		1	1	4932352744	4002395374021
Replacement flange nut M14.			✓	✓	✓	✓	1	1	4932345627	4002395313112

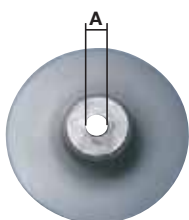

Cutting guards and dust extraction guards

Description	Fits 180mm angle grinders	Fits 230mm angle grinders	Pack quantity	Min. order quantity	Article Number	EAN Code
Dust guard for cutting, delivered with keyed guard reception and quick dust connector. Fits Milwaukee® AG 22.	✓	✓	1	1	4932459340	4058546010010
Dust guard for cutting, delivered with 2 keyless guard receptions and quick dust connector. Fits Milwaukee® AGV 22, AGVK 24 (PRC) and AG 21, AG 24 (CZW) Does not fit to LAG's equipped with autobalancer.	✓	✓	1	1	4932459341	4058546010027



Dust guards

Description	Fits 115 mm angle grinders	Fits 125 mm angle grinders	Pack quantity	Min. order quantity	Article Number	EAN Code
① Dust guard for cutting - DEC 125. 100% tool free connection to Ø 115 - 125 mm AG(V) 12, AGV 15 series and FUEL™ grinders, keyless depth adjustment from 5 - 28 mm. Guide to prevent twisting during cutting. Dust guard fits to the Milwaukee® M-Class cleaners with unique „click-system“ adaptor supplied with the vacuum cleaner.	✓	✓	1	1	4932430467	4002395381289
② Dust guard for surface conditioning - DEG 125. 100% tool free connection to Ø 125 mm AG(V) 12 and AGV 15 series grinders. Supplied with additional loop handle. Removable magnetic front cover to gain access to tight corners and edges when using a cup wheel. Dust guard fits to the Milwaukee® M-Class cleaners with unique „click-system“ adaptor supplied with the vacuum cleaner. Includes replaceable brush 4931448429.		✓	1	1	4932430468	4002395381296



Abrasive discs - Hook & Loop

Perforated sanding discs for wood, metal, paint, lacquer, plaster.

Grit type: fused alumina, half open.

Artificial resin-bonded on special tear resistant paper.

Sanding sheets for random orbital sanders Ø 125 mm - 8 holes

Grit	Paper size diameter (mm)	Pack quantity	Min. order quantity	Article Number	EAN Code
40	125	5	1	4932367740	4002395338610
60	125	5	1	4932367741	4002395338627
80	125	5	1	4932367742	4002395338634
120	125	5	1	4932367743	4002395338641
180	125	5	1	4932367744	4002395338658
240	125	5	1	4932367745	4002395338665
40	125	25	1	4932371470	4002395341870
60	125	25	1	4932371396	4002395341665
80	125	25	1	4932371397	4002395341672
120	125	25	1	4932371398	4002395341689
180	125	25	1	4932371399	4002395341696
240	125	25	1	4932371400	4002395341702

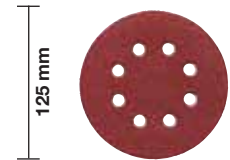

Sanding sheets for random orbital sanders Ø 150 mm - 6 holes

Grit	Paper size diameter (mm)	Pack quantity	Min. order quantity	Article Number	EAN Code
40	150	5	1	4932371590	4002395343171
60	150	5	1	4932371591	4002395343188
80	150	5	1	4932371592	4002395343195
120	150	5	1	4932371593	4002395343201
180	150	5	1	4932371594	4002395343218
240	150	5	1	4932371595	4002395343225
40	150	25	1	4932371596	4002395343232
60	150	25	1	4932371597	4002395343249
80	150	25	1	4932371598	4002395343256
120	150	25	1	4932371599	4002395343263
180	150	25	1	4932371600	4002395343270
240	150	25	1	4932371601	4002395343287

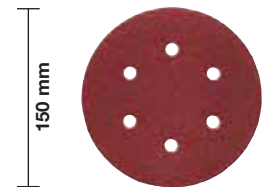

Abrasive sheets - Hook & Loop

Perforated sanding discs for wood, metal, paint, lacquer, plaster.

Grit type: fused alumina, half open.

Artificial resin-bonded on special tear resistant paper.

Sanding sheets for orbital sanders 80 x 133 mm

Grit	Paper size A x B (mm)	Pack quantity	Min. order quantity	Article Number	EAN Code
60	80 x 133	10	1	4932351666	4002395319305
80	80 x 133	10	1	4932351667	4002395319312
120	80 x 133	10	1	4932351668	4002395319329
180	80 x 133	10	1	4932351669	4002395319336
240	80 x 133	10	1	4932351670	4002395319343

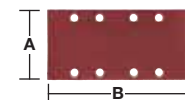

Sanding sheets for orbital sanders 115 x 107 mm

Grit	Paper size A x B (mm)	Pack quantity	Min. order quantity	Article Number	EAN Code
60	115 x 107	10	1	4932430815	4002395384761
80	115 x 107	10	1	4932430816	4002395384778
120	115 x 107	10	1	4932430817	4002395384785
240	115 x 107	10	1	4932430818	4002395384792

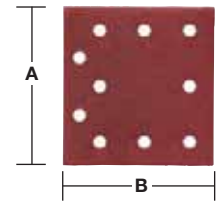

Abrasive sheets - Clamp type

Perforated sanding discs for wood, metal, paint, lacquer, plaster.

Grit type: fused alumina, half open. Artificial resin-bonded on special tear resistant paper.

Sanding sheets for orbital sanders 93 x 230 mm

Grit	Paper size A x B (mm)	Pack quantity	Min. order quantity	Article Number	EAN Code
50	93 x 230	10	1	4932305176	4002395300006
80	93 x 230	10	1	4932305177	4002395300013
100	93 x 230	10	1	4932305178	4002395300020
150	93 x 230	10	1	4932305179	4002395300037

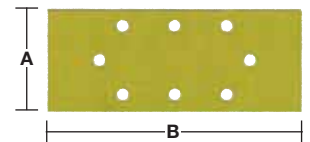

Sanding sheets for orbital sanders 115 x 140 mm

Grit	Paper size A x B (mm)	Pack quantity	Min. order quantity	Article Number	EAN Code
60	115 x 140	10	1	4932430819	4002395384815
80	115 x 140	10	1	4932430820	4002395384822
120	115 x 140	10	1	4932430822	4002395384846
240	115 x 140	10	1	4932430821	4002395384839

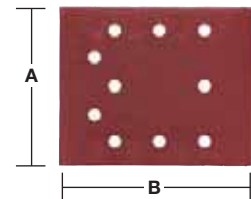

Abrasive sheets - Hook & Loop

Perforated sanding discs for wood, metal, paint, lacquer, plaster. Grit type: fused alumina, half open.

Artificial resin-bonded on special tear resistant paper.

Sanding sheets for delta sanders 105 x 105 mm

Grit	Paper size A x B (mm)	Pack quantity	Min. order quantity	Article Number	EAN Code
60	105 x 105	5	1	4932358492	4002395324248
80	105 x 105	5	1	4932358493	4002395324255
120	105 x 105	5	1	4932358494	4002395324262
180	105 x 105	5	1	4932358495	4002395324279
240	105 x 105	5	1	4932358496	4002395324286

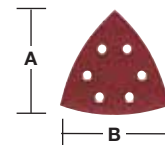

Sanding sheets for delta sanders 100 x 147 mm

Grit	Paper size A x B (mm)	Pack quantity	Min. order quantity	Article Number	EAN Code
60	100 x 147	10	1	4932355140	4002395319992
80	100 x 147	10	1	4932355141	4002395320004
120	100 x 147	10	1	4932355142	4002395320011
180	100 x 147	10	1	4932355143	4002395320028
240	100 x 147	10	1	4932355144	4002395320035

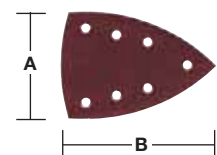

Abrasive belts

Cloth sanding belts for wood, metal, paint, lacqueur, plaster.

Grit type: fused alumina, half open.

Artificial resin-bonded on special fabric.

Sanding belts 75 x 533 mm

Grit	Paper size A x B (mm)	Pack quantity	Min. order quantity	Article Number	EAN Code
40	75 x 533	5	1	4932312475	4002395301263
60	75 x 533	5	1	4932312476	4002395301270
80	75 x 533	5	1	4932312477	4002395301287
100	75 x 533	5	1	4932312478	4002395301294
150	75 x 533	5	1	4932312479	4002395301300
240	75 x 533	5	1	4932312480	4002395301317

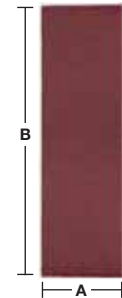

Sanding belts 100 x 560 mm

Grit	Paper size A x B (mm)	Pack quantity	Min. order quantity	Article Number	EAN Code
40	100 x 560	3	1	4932312099	4002395300419
60	100 x 560	3	1	4932312100	4002395300426
80	100 x 560	3	1	4932312101	4002395300433
100	100 x 560	3	1	4932312102	4002395300440
150	100 x 560	3	1	4932312103	4002395300457
240	100 x 560	3	1	4932312104	4002395300464

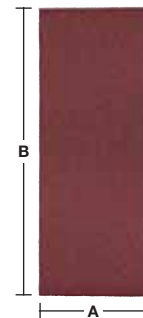

Sanding belts 100 x 610 mm

Grit	Paper size A x B (mm)	Pack quantity	Min. order quantity	Article Number	EAN Code
40	100 x 610	5	1	4932355066	4002395319824
60	100 x 610	5	1	4932355067	4002395319831
80	100 x 610	5	1	4932355068	4002395319848
100	100 x 610	5	1	4932355069	4002395319855
150	100 x 610	5	1	4932355070	4002395319862
240	100 x 610	5	1	4932355071	4002395319879

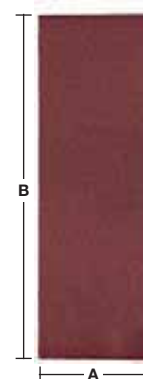

Sanding belts 100 x 620 mm

Grit	Paper size A x B (mm)	Pack quantity	Min. order quantity	Article Number	EAN Code
40	100 x 620	5	1	4932341610	4002395304882
60	100 x 620	5	1	4932341611	4002395304899
80	100 x 620	5	1	4932341612	4002395304905
100	100 x 620	5	1	4932341613	4002395304912
150	100 x 620	5	1	4932341614	4002395304929
240	100 x 620	5	1	4932341615	4002395304936

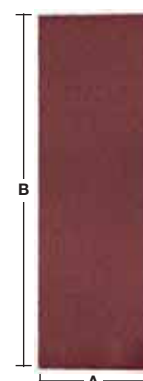

System accessories - Random orbital sanders

Description	Diameter (mm)	Fits random orbital sanders	Pack quantity	Min. order quantity	Article Number	EAN Code
Base plate Ø 125 mm, 8 holes. ① Complete with rubber ring as spare.	125	ROS 125 E	2	1	4932430091	4002395377527
Base plate Ø 150 mm, 6 holes. ① Complete with rubber ring as spare.	150	TXE 150, ROS 150 E	2	1	4932357591	4002395343317
		ROS 150 E			4932430145	4002395378067
Clean Line System. Frame with dust bag.	125	ROS 125 E	1	1	4931435448	4002395889563
	150	ROS 150	1	1	4931435911	4002395874729
Spare paper bags for 4932345544.		TXE 150, TX 125, ROS 150 E	5	1	4931442873	4002395247882
Frame holder for dust bag 4932313096.	125/150	ROS 150 E, TXE 150	1	1	4931329719	4002395610938
② Lambswool polishing disc. Finishing high gloss polishing.	150	ROS 150, ROS 150 E, TXE 150	1	1	4932373164	4002395347926
③ Lambswool polishing disc. 100% natural lambswool. Premium quality with extremely high fibre density for longer lifetime. Integrated soft touch layer guarantees perfect adjustment to flat and curved profiles. For finishing old and fresh paint. Extremely good polishing of temperature sensitive clear lacquers thanks to heat resistant fibres, e.g. polishing car bumper.	135	TX 125, ROS 125 E	1	1	4932430395	4002395380565
④ Polishing sponge hard. Polish up of weather-beaten lacquer, lacquer re-conditioning.	150	TXE 150, ROS 150 E, ROS 150	1	1	4932373165	4002395347940
⑤ Polishing sponge hard. Hard sponge with coarse foam structure. For maximum removal of the recondition-ing lacquer, removing deep scratches and polishing weather-beaten lacquer.	145	TX 125, ROS 125 E	1	1	4932430396	4002395380572

①



②



③



④



⑤



System attachments - Orbital sanders

Description	Fits orbital sanders	Pack quantity	Min. order quantity	Article Number	EAN Code
① Spare paper bags for 4932345544.	VSS 20, VSSE 20, VSS 22, VSSE 22, VS 230, VSS 260, VSSE 260	5	1	4931442873	4002395247882
② Dust bag, cloth. For use with Clean Line dust system 345547.		1	1	4932346182*	4002395313273
③ Extraction hose Ø 26 mm, 4 m. For connection to external extraction system.		1	1	4932278824	4002395308286

①



②



③



System attachments - Delta sanders

Description	Fits delta sanders	Pack quantity	Min. order quantity	Article Number	EAN Code
① Sanding plate delta 105 x 105 mm.	DSE 260	1	1	4932358439	4002395324231
② Dust bag made of sturdy fabric.	VS 11 D, FS 2, FS 2 D	1	1	4932351675	4002395320103
③ Adaptor for hose Ø 26 mm.	FS 2, FS 2 D, VS 11 D	1	1	4932351999	4002395320110
④ Extraction hose Ø 26 mm, 4 m. For connection to external extraction system.	FS 2, VS 11 D, FS 2 D	1	1	4932278824	4002395308286

①



②



③



④



System attachments - Belt sanders

Description	Fits belt sanders	Pack quantity	Min. order quantity	Article Number	EAN Code
① Extraction hose Ø 26 mm, 4 m. For connection to external extraction system.	HBSE 75 S, BS 100 S, BS 100 LE	1	1	4932278824	4002395308286
② Dust bag (spare).	BS 100 S, BS 100 LE	1	1	4932336597	4002395311026

①



②



Premium polishing accessories - Hook & Loop Ø 125 mm

Description	Diameter (mm)	Height (mm)	Pack quantity	Min. order quantity	Article Number	EAN Code
<p>① Polishing backing pad with M14 thread. Very flat design with excellent flexibility. Low vibration allows precise work on any flat and curved profiles.</p>	125		1	1	4932430394	4002395380558
<p>② Lambswool polishing disc. 100% natural lambswool. Premium quality with extremely high fibre density for longer lifetime. Integrated soft touch layer guarantees perfect adjustment to flat and curved profiles. For finishing old and fresh paint. Extremely good polishing of temperature sensitive clear lacquers thanks to heat resistant fibres, e.g. polishing car bumper.</p>	135	25	1	1	4932430395	4002395380565
<p>③ Polishing sponge hard. Hard sponge with coarse foam structure. For maximum removal of the reconditioning lacquer, removing deep scratches and polishing weather-beaten lacquer.</p>	145	30	1	1	4932430396	4002395380572
<p>④ Polishing sponge soft. Extremely soft sponge with fine foam structure. For fine polishing with polishing creams / wax compounds to remove very fine scratches and holograms (swirls).</p>	145	30	1	1	4932430397	4002395380589
<p>⑤ Microfibre polishing cloth. Super-soft premium microfibre polishing cloth for finishing gloss polishing. With good absorption properties perfectly suited for final finishing and removing water spots from sensitive surfaces. Machine-washable with 30° without softener.</p>	400 x 400		1	1	4932430398	4002395380596
<p>⑥ Polish M-Cut 1500 (250 ml). A coarse 1500 grit polish for removing deep scratches without damaging the lacquer. Suitable for removing dust grains, orange peel texture, lacquer/ paints runs and deep scratches. Free of wax, silicone and roxic solvents. Recommended for use with polishing sponge hard (4932430396) and lambswool polishing disc (4932430395).</p>			1	1	4932430475	4002395381364
<p>⑦ Polish M-Wax 6000 (250 ml). Premium high-tech wax with 6000 grit for removing fine scratches and sealing the paintwork in one step. Excellent performance in removing fine scratches / holograms / swirls. Contains the finest Brazilian Carnuba wax for long lasting mirror-like shine. Free of silicone. Recommended for use with polishing sponge soft (4932430397) and microfibre polishing cloth (4932430398).</p>			1	1	4932430476	4002395381371



①



②



③



④



⑤



⑥



⑦

Polishing accessories - Hook & Loop Ø 125 / 150 mm

Description	Diameter (mm)	Height (mm)	Pack quantity	Min. order quantity	Article Number	EAN Code
<p>Polishing backing pad. Application: Reception of felt / lambswool polishing discs and sponges. Characteristics: M14 thread, break resistant with integrated soft and flexible foam layer, Hook & Loop fixation.</p>	150	25	1	1	4932373161	4002395347285
<p>Felt polishing disc. Application: second polishing / finish of new lacquer work (spray mist and inclusion of dust), non ferrous metals and stainless steel, can also be used with polishing paste. Requires polishing backing.</p>	150	50	1	1	4932373163	4002395347902
<p>Lambswool polishing disc. Finishing high gloss polishing.</p>	150	25	1	1	4932373164	4002395347926
<p>Polishing sponge hard. Polish up of weather-beaten lacquer, lacquer re-conditioning.</p>	150	50	1	1	4932373165	4002395347940
<p>Polishing sponge soft. Second polish of lacquer, lacquer care.</p>	125	50	1	1	4932373184*	4002395347957
	150	50	1	1	4932373186	4002395347964
<p>Polishing sponge, super-soft, profiled. Polish up of lacquer, lacquer reconditioning, polishing of acrylic glass.</p>	125	25	1	1	4932373185*	4002395347971



Polishing accessories - Spot polisher

Description	Diameter (mm)	Height (mm)	Pack quantity	Min. order quantity	Article Number	EAN Code
<p>Polishing / Sanding backing pad. Thread: M9 x 0.75. Hook and loop fixation. For use with polishing sponges and abrasive paper.</p>	76		1	1	4932430488	4002395381494
<p>Polishing sponge - Hard (yellow). Hard sponge for use with more aggressive polish for removal of deep scratches. Hook and loop fixation. For use with polishing / sanding backing pad.</p>	75	25	1	1	4932430489	4002395381500
<p>Polishing sponge - Soft (white). Soft sponge for use with light polish for removal of small scratches. Hook and loop fixation. For use with polishing / sanding backing pad.</p>	80	25	1	1	4932430490	4002395381517
<p>Lambswool polishing pad. Hook and loop fixation. For use with polishing / sanding backing pad.</p>	80		1	1	4932430838	4002395385003
<p>Fibre disc backing pad. Thread: M9 x 0.75 to affix to tool. Knurled thread to fix coated abrasives and surface finishing products for coarse sanding applications, such as rust removal. Ideal for sanding small or awkward to reach areas such as pinch welds, door shuts and wheel arches.</p>	46		1	1	4932430492	4002395381531



* while stocks last

SAWZALL[®] blades

Shank reception



1/2" Universal shank

Suitable for the brands AEG, B&D, Bosch, DeWalt, Fein, Flex, Hilti, Makita, Metabo, Milwaukee[®], Porter Cable, Ridgid, Rothenberger, Ryobi, Skil.

Material qualities

To ensure maximum performance and lifetime, a number of different raw materials are used in the production of sabre saw blades. The raw material depends on the eventual application.

Bi-Metal

■ Bi-Metal blade. With high quality M2 steel cutting edge for all Heavy Duty applications.

Bi-Metal, Co

■ Bi-Metal blade with 8% cobalt. With premium Matrix II steel cutting teeth (with 8% cobalt content), the ultimate in performance and lifetime.

HCS

■ High carbon steel. Mostly suited to cutting wood and plastics.

Stainless

■ Stainless steel. Corrosion resistant blade.

TC

■ Carbide grit. For cutting cast iron pipes and abrasive materials.

■ Carbide tipped teeth. Suitable for glass fibre reinforced products and soft building blocks.

Bi-Metal blades consist of a hardened high speed steel cutting edge electron-beam welded onto a flexible alloy steel back. Bi-Metal blades are tougher, flexible reducing breakages, faster cutting and last longer than conventional carbon and all high speed steel blades. Those blades with cobalt have even harder teeth and offer double the lifetime in metal cutting applications and five times the lifetime over conventional high carbon steel blades.

The Milwaukee[®] advantage

SAWZALL[®] Blades

- Up to 50% longer life
 - Unique cryogenic heat treatment process provides tougher teeth for extreme applications
 - Excellent cutting performance and lifetime in difficult materials such as stainless steel
- ✓ Upto 65 HRC tooth hardness with cobalt for the most demanding applications in all metals and high alloy steels.
 - ✓ The blade body has a high level of elasticity and significantly reduces the risk of blade breakage.
 - ✓ Matrix II Bi-Metal strip with 8% cobalt teeth can endure high wear rates and is very heat resistant ensuring longer life.

Comparative test in 100 mm steel pipe

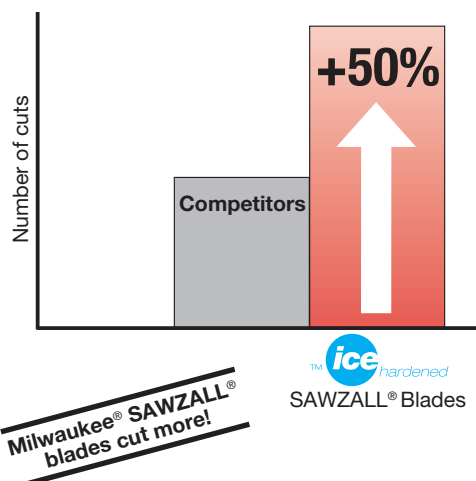

Blade shapes

SAWZALL® blades can be manufactured in many various shapes. The shape is adjusted to the application. The thickness of the blade depends on the required flexibility. More demanding applications like cutting tubes require thick blades, less demanding applications require thin, narrow blades.

The blade shapes can be divided into four different groups:

1. Universal blades



The universal blade is for general use. Its even width guarantees good cutting stability and excellent guidance. This enables straight edge cutting through many different materials.

3. Scroll blades



These blades are especially used for curve cutting. The more narrow the blade, the smaller a radius can be cut.

2. Sloped blades



Sloped blades are commonly used when cutting wood and demolition applications. The narrow tip allows for plunge cuts and curve cutting. This shape is rarely used when working in metal, since the tip does not have the necessary strength required for this application.

4. Special scroll blades



Special scroll blades were developed for both straight and curve cutting in soft material like plaster-board. The blade is wide at the rear (for straight cutting) and narrow at the front (for curve cutting).

Packaging

Our SAWZALL® blade packaging is totally language free, technical characteristics and applications are clearly illustrated for easy self-service. Blades are offered in two forms of packaging, a economic pack and for the industrial users a bulk pack container. Both forms of packaging can be reused as a storage facility for used blades.



Tooth geometry

The blade length (A) represents the complete length of the blade – A.
 The tooth pitch is shown in millimetres (mm) and in inches.

Tooth pitch in mm

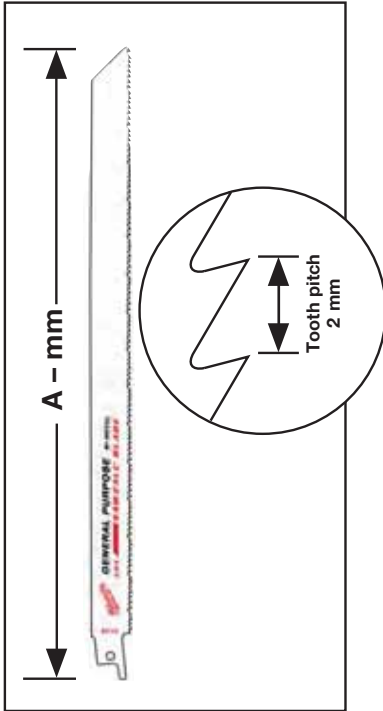

Teeth per inch

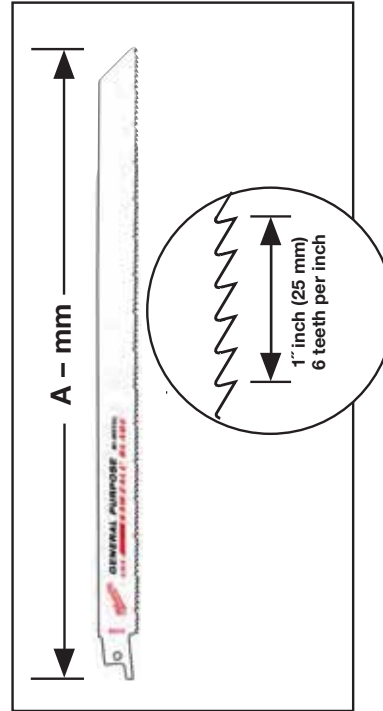

To attain the correct blade length, it is necessary to take the width of material to be cut and add an extra 80 mm. Selecting the correct tooth pitch for the material being cut is dependent on the thickness of the material being cut, this is extremely important when cutting metals to ensure the blade is used to its optimum performance. The golden rule is to have three teeth in contact with the material being cut at all times. When cutting wood the higher the tooth pitch in mm's (the lower in inches) the rougher and coarser the cut will be.





For cutting metal the following table can be used for guidance.

Material – All metals – Tubing/profiles/channels	Tooth pitch (mm)	Teeth per inch
Wall thickness 4.5 mm to 10 mm	1.8	14
Wall thickness 3.0 mm to 4.5 mm	1.4	18
Wall thickness less than 3 mm (thin materials)	1.0	24

Application guidelines

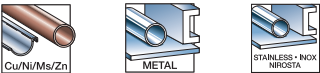

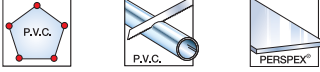



Cut Cool – Cut Faster – Cut Longer

To ensure longer life, it is recommended to use a cooling lubricant, which can result in extending the life of the saw blade by up to 500%.

Material	Coolant
	Cutting oil
	Turpentine
	Compressed air
	Water
	Dry

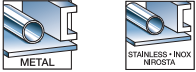
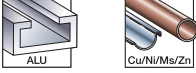
Cutting Speed Recommendation

The following table can be used as a rough guide, however the material wall thickness must also be considered when deciding on the correct speed.

Material	Speed – max. strokes per minute
 Less than 600 N/mm ² strength	2000
 Between 600 N/mm ² – 800 N/mm ² strength	1500
 Over 800 N/mm ² strength	500
	1500
	1000
	500
	2000 – 2800

Wood and plastics

Blade length (mm)	Tooth pitch (mm)	Teeth per inch	Ref. No.						Pack quantity	Min. order quantity	Article Number	EAN Code	
	150	4.2	6	S644D	6 - 100	-	6 - 100	No	Yes	3	1	48001075	045242079810
	150	4.2	6	S744D	6-50	-	6-50	Yes	No	3	1	48001076	045242079827
	230	4.2	6	-	6 - 190	6 - 190	6 - 100	No	Yes	5	1	48005016	045242082636
	240	5.5/6	4/5	S1531L	15 - 190	15 - 190	-	No	No	3	1	48001077	045242079834
	240	8.5	3	S1542K	15 - 190	-	-	No	No	3	1	48001078	045242079841
	300	4.2	6	S1344D	6 - 250	-	-	No	No	3	1	48001079	045242079858

Wood with nails: THIN KERF Demolition blades

- **FANG TIP™**: For faster plunge cutting and reaching into restricted areas.
- **NAIL GUARD™**: Protects the tooth during nail impacts for increased durability and lifetime.
- **Strong**: 1.25 mm thick blade body for good strength and blade life making it ideal for wood with nails or bolts.
- **Fast**: Aggressive 5 TPI geometry removes more material per stroke for faster cutting.
- **Sloped shape**: Excellent for plunge cutting and reaching into restricted areas.
- **Shatter resistant**: Bi-Metal construction allows the blade to bend and flex without breaking.





Blade length (mm)	Tooth pitch (mm)	Teeth per inch	Ref. No.						Pack quantity	Min. order quantity	Article Number	EAN Code		
	150	5	5	S611DF	10 - 100	10 - 100	Ø 10 - 100	10 - 50	Yes	Yes	5	1	48005035	045242082698
	230	5	5	S1111DF	10 - 175	10 - 175	Ø 10 - 175	10 - 50	Yes	Yes	5	1	48005036	045242082704
	300	5	5	S1411DF	10 - 250	10 - 250	Ø 10 - 250	10 - 50	No	Yes	5	1	48005037	045242082711

Wood with nails: Heavy Duty AX Demolition blades

THE AX™

- **FANG TIP™**: For faster plunge cutting and reaching into restricted areas.
- **NAIL GUARD™**: Protects the tooth during nail impacts for increased durability and lifetime.
- **Strong**: Extra thick 1.60 mm body for maximum robustness and life making it ideal for wood with nails or bolts.
- **Fast**: Aggressive 5 Tpi tooth geometry removes more material per stroke for faster cutting.
- **Sloped shape**: Excellent for plunge cutting and reaching into restricted areas.
- **Shatter resistant**: Bi-Metal construction allows the blade to bend and flex without breaking.



Blade length (mm)	Tooth pitch (mm)	Teeth per inch	Ref. No.							Pack quantity	Min. order quantity	Article Number	EAN Code	
	5	5	-	10 - 100	10 - 100	Ø 10 - 100	10 - 50	Yes	Yes	Yes	5	1	48005021	045242082988
											25	1	48008021	045242082285
	5	5	-	10 - 175	10 - 175	Ø 10 - 175	10 - 50	Yes	Yes	Yes	5	1	48005026	045242082995
											25	1	48008026	045242082292
	5	5	-	10 - 250	10 - 250	Ø 10 - 250	10 - 50	Yes	Yes	Yes	5	1	48005027	045242083022
											25	1	48008027	045242082308

Wood with nails: Heavy Duty AX Carbide demolition blades



AX™

CARBIDE TEETH







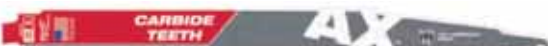

- Up to 30x longer life than standard Bi Metal blades. Carbide teeth deliver long life and extreme durability in the toughest applications. Cuts through hardened screws and fasteners.
- Up to 2x faster than standard Bi Metal blades. A fast and aggressive 5TPi tooth pattern allows for the fastest cutting in nail embedded wood and a wide range of construction materials (wood/nails/bolts/screws/cast iron/asphalt roofing felt shingles)
- Up to 25% more cuts per charge vs. standard Bi Metal blades. Optimised for use with cordless reciprocating saws.
- **FANG TIP™** for faster plunge cutting and reaching into restricted areas.
- **NAIL GUARD™** protects the tooth during nail impacts for increased durability and lifetime.
- Sloped shape, excellent for plunge cutting and reaching into restricted areas.



Blade length (mm)	Tooth pitch (mm)	Teeth per inch	Ref. No.							Pack quantity	Min. order quantity	Article Number	EAN Code	
	5	5	-	10 - 100	10 - 100	Ø 10 - 100	10 - 50	Yes	Yes	Yes	1	1	48005221	045242483716
											5	1	48005521	045242521104
	5	5	-	10 - 175	10 - 175	Ø 10 - 175	10 - 50	Yes	Yes	Yes	1	1	48005226	045242483723
											5	1	48005526	045242521111
	5	5	-	10 - 250	10 - 250	Ø 10 - 250	10 - 50	Yes	Yes	Yes	1	1	48005227	045242483730
											5	1	48005527	045242521128



Wood / Metal / Plastic: Universal blades

Blade length (mm)	Tooth pitch (mm)	Teeth per inch	Ref. No.	METAL	Cu/Ni/Ms/Zn	ALU	Stainless-inox	Plastic	P.V.C.	P.V.C.	Pack quantity	Min. order quantity	Article Number	EAN Code		
	150	2.5	10	-	3 - 10	3 - 10	5 - 50	3 - 10	5 - 50	No	Ø 3 - 50	10 - 50	5	1	48005092	045242082766
	150	2.5/1.8	10/14	SS922VF	3 - 10	3 - 10	5 - 100	3 - 10	5 - 100	No	Ø 3 - 100	10 - 50	5	1	48005292	045242084067
	200	2.5/1.8	10/14	-	3 - 10	3 - 10	5 - 175	3 - 10	5 - 175	Yes	Ø 3 - 160	10 - 50	5	1	48005293	045242084074
	300	2.5/1.8	10/14	-	3 - 10	3 - 10	5 - 250	3 - 10	5 - 250	Yes	Ø 3 - 250	10 - 50	5	1	48005194	045242082926
	150	3.2/2.1	8/12	-	3 - 10	3 - 10	5 - 100	3 - 10	5 - 100	No	Ø 3 - 100	10 - 50	5	1	48005091	045242082759
	200	3.2/2.1	8/12	-	3 - 10	3 - 10	5 - 175	3 - 10	5 - 175	Yes	Ø 3 - 160	10 - 50	5	1	48005093	045242082773
	300	3.2/2.1	8/12	-	3 - 10	3 - 10	5 - 250	3 - 10	5 - 250	Yes	Ø 3 - 250	10 - 50	5	1	48005094	045242082780
													50	1	48016293	045242084098
													50	1	48016091	045242084685
													500	1	48016093	045242084708
													500	1	48016000	045242084951
													50	1	48016094	045242084715

Metal: Extra Heavy Duty

THE WRECKER[™]

- Strong and precise: Extra thick 1.60 mm blade body.
- Bi-Metal construction: Excellent blade life and performance.
- Tooth geometry: Aggressive strengthened tooth tip design and uniform gullet depth allows for more material to be removed per stroke for faster cutting.
- Blade shape: Sloped - The sloped shape makes this blade ideal for plunge cutting. Most suited for cutting metal and for demolition applications (wood with nails).

Blade length (mm)	Tooth pitch (mm)	Teeth per inch	Ref. No.	METAL	METAL	Cu/Ni/Ms/Zn	STAINLESS-INOX	Plastic	Plastic	Plastic	Pack quantity	Min. order quantity	Article Number	EAN Code	
	150	3.2	8	1	4 - 10	Ø 10 - 100	4 - 10	4 - 10	Yes	Yes	Yes	5	1	48005701	045242082476
	230	3.2	8	1	4 - 10	Ø 10 - 160	4 - 10	4 - 10	Yes	Yes	Yes	5	1	48005706	045242082483
	300	3.2	8	1	4 - 10	Ø 10 - 180	4 - 10	4 - 10	Yes	Yes	Yes	5	1	48005711	045242082490

Metal: THIN KERF blades

TOUGH NECK

STRONGEST

QUICKEST THIN KERF

LONGEST

DOUBLE DUTY UPGRADE

2X LIFE*

Improved tooth geometry for best speed and double the lifetime. Bi-Metal quality cutting teeth with 8% Cobalt the ultimate in performance and lifetime.

TOUGH NECK

Stamped indentations around the reception strengthens the blade at its weakest point.

THIN KERF

Slim 0.90 mm thick blade body optimised for maximum speed and flexibility.















ice hardened

Unique cryogenic heat treatment process gives

- tougher teeth for cutting the hardest of metals
- up to 50% longer life vs. standard Bi Metal blades

*vs. standard Bi Metal blades

Metal: THIN KERF blades

Blade length (mm)	Tooth pitch (mm)	Teeth per inch	Ref. No.	Material Compatibility										Pack quantity	Min. order quantity	Article Number	EAN Code
				METAL	METAL	METAL	Cu/Ni/Ms/Zn	STAINLESS-ROCK/INOX/PIROXITA	ALU								
	100	1	25	S522AF	0.5 - 3	0.5 - 3	Ø 8 - 50	0.5 - 3	0.5 - 3	-	No	No	5	1	48005185	045242082865	
	150	1	25	S922AF	0.5 - 3	0.5 - 3	Ø 8 - 100	0.5 - 3	0.5 - 3	-	No	No	5	1	48005186	045242082872	
	100	1.4	18	S522EF	1.5 - 4	1.5 - 4	Ø 10 - 50	1.5 - 4	1.5 - 4	-	No	No	5	1	48005183	045242082841	
	150	1.4	18	S922EF	1.5 - 4	1.5 - 4	Ø 10 - 100	1.5 - 4	1.5 - 4	-	No	No	5	1	48005184	045242082858	
													50	1	48016184	045242084739	
	150	1.4	18	S922EF	1.5 - 4	1.5 - 4	Ø 10 - 100	1.5 - 4	1.5 - 4	-	No	No	5	1	48004184	045242081042	
	230	1.4	18	S1122EF	1.5 - 4	1.5 - 4	Ø 10 - 100	1.5 - 4	1.5 - 4	-	No	No	5	1	48005188	045242082896	
													50	1	48016188	045242084876	
	230	1.4	18	S1122EF	1.5 - 4	1.5 - 4	Ø 10 - 160	1.5 - 4	1.5 - 4	-	No	No	5	1	48004188	045242081066	
	300	1.4	18	-	1.5 - 4	1.5 - 4	Ø 10 - 180	1.5 - 4	1.5 - 4	-	No	Yes	5	1	48005189	045242082902	
													50	1	48016189	045242084883	
	90	1.8	14	S422BF	1.5 - 6	1.5 - 6	-	1.5 - 4	-	1.5 - 6	Yes	No	5	1	48005162	045242082803	
	100	1.8	14	S522BF	3 - 10	-	Ø 10 - 50	3 - 10	2 - 4	3 - 10	No	No	5	1	48005181	045242082827	
	150	1.8	14	S922BF	3 - 10	-	Ø 10 - 100	3 - 10	2 - 4	3 - 10	No	No	5	1	48005182	045242082834	
													50	1	48016182	045242084722	
	150	1.8	14	S922BF	3 - 10	-	Ø 10 - 100	3 - 10	2 - 4	3 - 10	No	No	5	1	48004182	045242081035	
	230	1.8	14	S1122BF	3 - 10	-	Ø 10 - 160	3 - 10	2 - 4	3 - 10	No	No	5	1	48005187	045242082889	
													50	1	48016187	045242084869	
	230	1.8	14	S1122BF	3 - 10	-	Ø 10 - 160	3 - 10	2 - 4	3 - 10	No	No	5	1	48004187	045242080991	

Metal: Heavy Duty demolition blades

THE TORCH™

STRONGEST

DOUBLE DUTY UPGRADE™

2X LIFE*

Improved tooth geometry for best speed and double the lifetime.
 Thick 1,06 mm robust blade body for precise cuts.
 25 mm blade height for improved stability and minimum vibration.
 Bi-Metal quality cutting teeth with 8 % Cobalt the ultimate in performance and lifetime.

TOUGH NECK

Stamped indentations around the reception strengthens the blade at its weakest point.

GRID IRON™

A grid iron pattern is built into the blade to make it more rigid with less tendency to bend or buckle for best durability and straight cuts.

ice™ hardened

Unique cryogenic heat treatment process gives

- tougher teeth for cutting the hardest of metals
- up to 50% longer life vs. standard Bi Metal blades

*vs. standard Bi Metal blades

Metal: Heavy Duty demolition blades

Blade length (mm)	Tooth pitch (mm)	Teeth per inch	Ref. No.							Pack quantity	Min. order quantity	Article Number	EAN Code	
	150	1.4	18	-	2 - 8	Ø 10 - 100	2 - 8	2 - 4	No	Yes	5 25	1 1	48005784 48008784	045242083084 045242082407
	150	1.4	18	-	2 - 8	Ø 10 - 100	2 - 8	2 - 4	No	Yes	5	1	48004784	045242081110
	230	1.4	18	-	2 - 8	Ø 10 - 160	2 - 8	2 - 4	No	Yes	5 25	1 1	48005788 48008788	045242083091 045242082421
	230	1.4	18	-	2 - 8	Ø 10 - 160	2 - 8	2 - 4	No	Yes	5	1	48004788	045242081134
	300	1.4	18	-	2 - 8	Ø 10 - 180	2 - 8	2 - 4	No	Yes	5 25	1 1	48005789 48008789	045242083107 045242082438
	150	1.8	14	-	3 - 10	Ø 10 - 100	3 - 10	3 - 7	Yes	Yes	5 25	1 1	48005782 48008782	045242083060 045242082391
	150	1.8	14	-	3 - 10	Ø 10 - 100	3 - 10	3 - 7	Yes	Yes	5	1	48004782	045242081097
	230	1.8	14	-	3 - 10	Ø 10 - 160	3 - 10	3 - 7	Yes	Yes	5 25	1 1	48005787 48008787	045242083077 045242082414
	230	1.8	14	-	3 - 10	Ø 10 - 160	3 - 10	3 - 7	Yes	Yes	5	1	48004787	045242081127
	150	2.5	10	-	4 - 10	Ø 10 - 100	4 - 10	4 - 10	Yes	Yes	5 25	1 1	48005712 48008712	045242083039 045242082377
	150	2.5	10	-	4 - 10	Ø 10 - 100	4 - 10	4 - 10	Yes	Yes	5	1	48004712	045242081073
	230	2.5	10	-	4 - 10	Ø 10 - 160	4 - 10	4 - 10	Yes	Yes	5 25	1 1	48005713 48008713	045242083046 045242082384
	230	2.5	10	-	4 - 10	Ø 10 - 160	4 - 10	4 - 10	Yes	Yes	5	1	48004713	045242081080

Metal: Heavy Duty TORCH™ Carbide teeth demolition blades **NEW**

- Carbide teeth provide for longest life in thick metals. Up to 50x more life compared to Bi-Metal blades.
- Thick 1.27 mm robust blade body for precise straight cuts.
- 25 mm blade height for improved stability and minimum vibration.



THE **TORCH™**
CARBIDE TEETH

*Compared to bi-metal

Blade length (mm)	Tooth pitch (mm)	Teeth per inch	Ref. No.	METAL	METAL	Cu/Ni/Ms/Zn	THICK METAL	SPAINLESS-IRON INROSTA	THICK METAL	RESCUE	Pack quantity	Min. order quantity	Article Number	EAN Code
150	3.6	7	-	5 - 13	Ø 10 - 100	5 - 13	Ø 10 - 100	5 - 13	Yes	Yes	1	1	48005201	045242521036
											5	1	48005501	045242520862
230	3.6	7	-	5 - 13	Ø 10 - 175	5 - 13	Ø 10 - 175	5 - 13	Yes	Yes	1	1	48005202	045242520787
											5	1	48005502	045242520879
300	3.6	7	-	5 - 13	Ø 10 - 250	5 - 13	Ø 10 - 250	5 - 13	Yes	Yes	1	1	48005203	045242520794
											5	1	48005503	045242520886

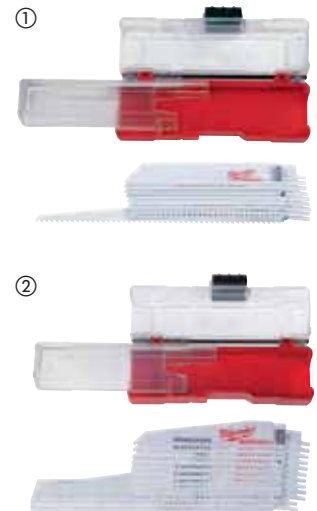

SAWZALL® sets

Description	Pack quantity	Min. order quantity	Article Number	EAN Code
Sawzall blade set (9 pcs).				
① 2 x Demolition - wood with nails 150 mm x 5 Tpi (48005035), 1 x Demolition - wood with nails 230 mm x 5 Tpi (48005036), 3 x Metal 3-10 mm 150 mm x 14 Tpi (48005182), 3x Metal thin 0,5-3 mm 150 mm x 24 Tpi (48005186).	9	1	49221145	045242043521
Sawzall blade set (12 pcs)				
② 2 x AX Demolition - wood with nails 150 mm x 5Tpi (48005021), 2 x AX Demolition - wood with nails 230 mm x 5Tpi (48005026), 2 x Wrecker Metal straight cuts 4-10 mm, 150 mm x 8Tpi (48005701), 2 x Torch Metal 3-10 mm, 230 mm x 14 TPI (48005787), 4 x Torch Metal 2-8 mm, 150 mm x 18 TPI (48005784).	12	1	49221129	045242180813







SAWZALL® blades for special materials



Special application: cast iron / abrasive materials / fibreglass

Blade length (mm)	Tooth pitch (mm)	Teeth per inch	Ref. No.						Pack quantity	Min. order quantity	Article Number	EAN Code	
	230	Coarse grit	-	Ø 10 - 160	Ø 10 - 160	3 - 175	-	-	1	1	48001450	045242187416	
	150	Coarse grit	-	Ø 10 - 100	Ø 10 - 100	3 - 100	-	-	3	1	48001420	045242081950	
	230	Coarse grit	S1130R	Ø 10 - 160	Ø 10 - 160	3 - 175	-	-	3	1	48001430	045242082001	
	305	8.5	3	S1241HM	-	-	6 - 150	10 - 250	1	1	48001080	045242079865	
	450	17.0	1.5	-	-	-	6 - 150	10 - 350	10 - 350	1	1	48001460	045242235353

Special application: insulation material / carton / foam

Blade length (mm)	Tooth pitch (mm)	Teeth per inch	Ref. No.					Pack quantity	Min. order quantity	Article Number	EAN Code	
	300	Wave knife	Wave knife	-	Yes	Yes	Yes	Yes	1	1	48001084	045242079902

Special application: frozen materials

	300	4.2	6	S1211K					1	1	48001082	045242079889
	400	4.2	6	-					1	1	48001083	045242079896

Special Application: flush cut blade



- Flush cuts against floor - floor guard protects teeth from floor contact when cutting flush to the floor.
- Extra tall blade body - guides blade for straighter cuts ie. when cutting out doors and windows in wood construction.
- FANG TIP[™] - for easy and quick plunging.
- Suitable for cutting all types of wood and nail embedded wood. Not suitable for brick, masonry or steel.

Blade length (mm)	Tooth pitch (mm)	Teeth per inch	Ref. No.	Pack quantity	Min. order quantity	Article Number	EAN Code
300	5	5	-	1	1	48001600	045242253272

Special application: ductwork blade

- Plunge tip - fast plunging in materials < 0,6 mm. No need for extra tools.
- Versatility - tapered blade body profile allows for tight radius cutting and square cuts.
- Longlife - optimized tooth geometry 30 tpi for cutting thin material 0,6 - 1,5 mm. Most common spiral duct is 0,8 mm thick.



Blade length (mm)	Tooth pitch (mm)	Teeth per inch	Pack quantity	Min. order quantity	Article Number	EAN Code
85	0,8	30	5	1	48001630	045242300174

Special application: drywall / plasterboard blade



- Precise depth of cut - only 63 mm long, protects from unintentional cuts in pipes or wiring.
- Double sided teeth - cuts in ALL directions - produces less dust than jobsaw handtool - cuts clean without ripping the drywall.
- Plunge tip - fast and effortless plunging.

Blade length (mm)	Tooth pitch (mm)	Teeth per inch	Yes	Yes	Pack quantity	Min. order quantity	Article Number	EAN Code
63	-	-	Yes	Yes	1	1	48001640	045242300181

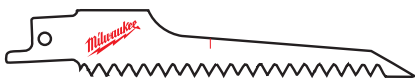

125	4.2	6	Yes	Yes	5	1	48005052	045242082735
-----	-----	---	-----	-----	---	---	----------	--------------

System accessories - SAWZALL®

Description	Fits SAWZALL	Pack quantity	Min. order quantity	Article Number	EAN Code
Conversion kit: to convert FIXTEC blade reception models to keyed blade reception to accept 20 mm reception blades.	SSE 1000 QX,SSPE 1000 QX,SSH 800 QX Hatchet, PSH 18v hatchet,V18 SX,SSPE 1300 QX, M18 FUEL™ SAWZALL,USE 980 X,V28 SX, SSPE 1500 X	1	1	42680685	
Clamp.		1	1	06832976	
Screw.		1	1	49960070	045242221554
Allen Key 5/32"		1	1	49960070	045242221554
Conversion kit: to convert FIXTEC blade reception models to keyed blade reception to accept 1/2" universal reception blades.	SSE 1000 QX,SSPE 1000 QX,SSH 800 QX Hatchet, PSH 18v hatchet,V18 SX,SSPE 1300 QX, M18 FUEL™ SAWZALL,USE 980 X,V28 SX, SSPE 1500 X	1	1	49225016	045242182060
Clamp.		1	1	06832976	
Screw.		1	1	49960070	045242221554
Allen Key 5/32"		1	1	49960070	045242221554
Conversion kit: to convert standard 1/2" keyed blade reception models to keyed blade reception to accept 20 mm reception blades.	SSE 1000 AVS, SSE 1000 SQ, SSPE 1300 SQ	1	1	42680647*	
Clamp.		1	1	06832960*	
Screw.		1	1	49960080*	045242221608
Allen Key 5/32"		1	1	49960080*	045242221608
Transport case for sabre saws / SAWZALLS®.	SSE 1000 AVS, SSE 1000 SQ, SSE 1000 QX, SSPE 1000 QX, SSD 1100 X, SSPE 1300 QX, SSPE 1300 SQ, M18 FUEL™ SAWZALL, SSDE 1500 X,V18 SX,V28 SX	1	1	48556510	045242148424
	V18 SX,V28 SX	1	1	201602001	4002395836383
Cases supplied with latches and foam insert. Size 1 (L x W x H) 475 x 358 x 132 mm.	PSH 18v hatchet	1	1	4932378986	4002395349401

* while stocks last

HACKZALL[™] Blades

- Especially engineered blades for exclusive use on 12 V HACKZALL[™].
- Bi-Metal construction for increased tooth durability.
- Optimised tooth form for aggressive and faster cutting.
- Thinner blade body for better speed of cut and up to 35% more cuts per charge vs. standard Bi Metal blades.

Blade length (mm)	Tooth pitch (mm)	Teeth per inch							Pack quantity	Min. order quantity	Article Number	EAN Code		
	100	4.2	6	-	-	-	-	6 - 40	Ø 10 - 40	5	1	49005460	045242160273	
	150	1.8	14	3 - 6	Ø 10 - 32	3 - 6	3 - 6	-	Ø 10 - 50	5	1	49005614	045242160334	
	100	1.4	18	1.5 - 4	Ø 10 - 32	1.5 - 4	-	-	-	5	1	49005418	045242160341	
	100	1	25	0.5 - 3	Ø 8 - 32	0.5 - 3	-	-	-	5	1	49005424	045242160358	
	75	-	-	-	-	-	-	-	-	1	1	49005456	045242219476	75 mm scraper: for removing strong adhesive silicon, caulk, paint and rust.
	125	-	-	-	-	-	-	-	-	1	1	49005455	045242293421	125 mm wide scraper: for removing glue, silicon, caulk, vinyl, rust, paint and wallpaper.
	60	-	-	-	-	-	-	-	-	1	1	49005450	045242221066	Grout removal blade: for removing damaged or moulded grout between tiles.
	10 pc set									10	1	49220220	045242160365	2 x 49005460, 3 x 49005614, 3 x 49005424, 2 x 49005418.

Jigsaw blades

Material qualities

HCS

- High Carbon Steel jigsaw blades are used for cutting all types of wood and plastics.

HSS

- High Speed Steel blades are suited to cutting metal, non ferrous metal and aluminium.

Carbide grit

- These blades have a tungsten carbide grit edge making them suitable for abrasive materials.

TC

- Blades with tungsten carbide tipped teeth are ideally suited to glassfibre reinforced products. Those blades with a continuous tungsten carbide tooth strip cutting edge are suitable for extremely hard materials such as stainless steel.

Bi-Metal

- Bi-Metal blades consist of high speed steel teeth electron beam welded onto a flexible alloy steel back. These blades offer maximum performance in the most demanding applications in both wood and metal.

Bi-Metal blades offer the following benefits:

- Flexible and shatter resistant
- Longer lifetime. Metal cutting blades offer double the lifetime and wood cutting blades more than 5 times the lifetime over conventional HCS and HSS blades.
- High wear rate and heat resistance ensure the teeth stay sharp longer.
- Faster cutting performance.

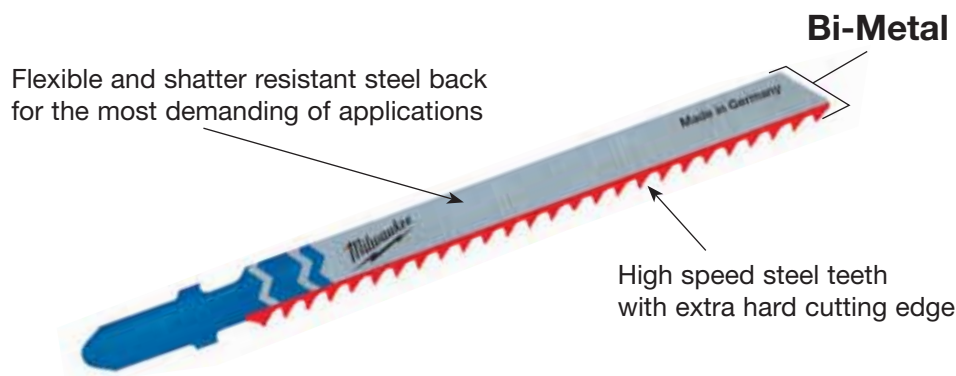



Blade colour code

Shank colour means application

 2743 51 = For all types of wood, laminated chipboard, chipboard, plywood, blockboard and plastics. Silver colour blade body.

 2540 63 = For all types of ferrous and non-ferrous metals, steel, aluminium, brass, copper, stainless steel, lead, tin and sandwich materials. Silver colour blade body.

 3733 87 = For cutting a range of products, carton, rubber, fibreglass, foam and abrasive materials. Black colour blade body.

 3733 90 = Bi-Metal blades come with a white body and then the corresponding colour shank; yellow for wood and blue for metal.

Shank receptions

T-Shank blades

- Suitable for most major brands.

AEG, Bosch, DeWalt, Festool, Hitachi, Hilti, Mafell, Makita, Metabo, Milwaukee®, Ryobi.



Special shank blades

- We do also offer a range of the most popular blades with either the Makita, or U-Shank reception.

U-Shank: for Black & Decker, Kress, Ryobi, Skil



Packaging



- Common blades are available in 5 and bulk 25 pack quantities. Our 25 pack packaging is reusable allowing for blades to be removed and returned easily.
- Our colour system on the blades is also featured on our packaging in conjunction with our pictograms to ensure you have the right blade for the application.

Technical tips

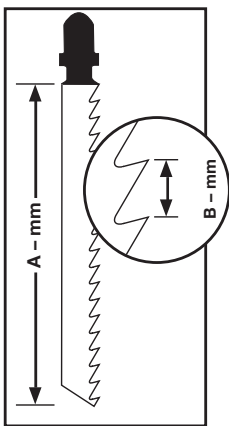

- The blade length represents the section of the blade with cutting teeth (A–mm). The tooth pitch is measured in millimetres (mm) from tooth point to tooth point (B–mm). Selecting the correct tooth pitch is dependent on the thickness of material being cut. The golden rule is to have three teeth in contact with the material being cut at all times; this is the optimum, as a guidance for thick material such as metals over 4 mm thickness a tooth pitch of 2 mm or more is recommended. For metals with a thickness of 1.5–3.5 mm a tooth pitch of 1.2 to 1.4 is desirable. When cutting thin metal sheet material below 1.5 mm a tooth pitch of 0.7 to 1.2 mm is recommended. The general rule when cutting wood is the higher the tooth pitch the faster and rougher / coarser the cut will be.
- When cutting extremely thin sheet material it is recommended to place the material onto a thicker backing to prevent the sheet material from breaking.
- We recommend the use of a cooling lubricant to extend the life of the saw blade when cutting metals and plastics.

Material	Coolant
	Cutting oil
	Turpentine
	Water

Jigsaw blades for wood and plastic



Traditional blades

Traditional blades that deliver good and solid performance.

Blade length (mm)	Tooth pitch (mm)	Ref. No.									Pack quantity	Min. order quantity	Article Number	EAN Code	
50	2	T 119 B	< 20	-	< 20	Yes	-	No	No	No	5	1	4932274353	4002395301553	
75	3	T 111 C	5 - 50	-	< 40	-	Yes	No	No	No	5	1	4932254071	4002395301539	

Curve cutting blades

All of our curve cutting blades are characterised by a narrow blade body for improved manoeuvrability.

Jigsaw blade 4932265312 and 4932430143 has cutting teeth on both sides.

The teeth on the back of the blade allows one to cut tight and acute curves with simplicity.

For best results work without pendulum action when cutting tight curves.

50	1.35	T 101 A0	< 20	< 20	< 15	Yes	No	Yes	No	No	5	1	4932373392	4002395348879	
50	2	T 119 B0	< 20	-	< 20	Yes	No	Yes	No	No	5	1	4932274650	4002395301485	
75	2.5	Curve	< 30	< 20	< 20	Yes	No	Yes	No	Yes	5	1	4932430143	4002395378043	
75	4 / 1.2	Special	< 30	-	< 30	No	Yes	Yes	No	No	5	1	4932265312	4002395301478	
75	4	T 244 D	< 50	-	-	No	Yes	Yes	No	Yes	5	1	4932346078	4002395312375	
											25	1	4932373492	4002395349920	

Fast cut blades

The sharp and aggressive tooth geometry is ideal for very fast cutting of wood.

75	4	T 144 D	< 50	-	-	No	Yes	No	No	Yes	5	1	4932213116	4002395301492	
											25	1	4932373487	4002395349272	
											100	1	4932430461	4002395381227	
Bi-Metal	75	4	T 144 DF	< 50	-	-	No	Yes	No	No	Yes	5	1	4932373391	4002395348862
105	4	T 344 D	< 80	-	-	No	Yes	No	No	Yes	5	1	4932311633	4002395301508	
155	4	T 744 D	5-125	-	-	No	Yes	No	No	Yes	5	1	4932354745	4002395324095	

Fast and clean cutting blade

Triple sharpened tooth geometry for fast and super clean splinter free cuts. Plunge tip for fast plunging.

Blade length (mm)	Tooth pitch (mm)	Ref. No.									Pack quantity	Min. order quantity	Article Number	EAN Code
91	2.5	T 234 X	3 - 60	3 - 60	Yes	< 45	No	No	Yes	No	5	1	4932430141	4002395378029

Clean and splinter free cutting blades

The following blades have diagonally sharpened side teeth resulting in a very clear splinter free cut.

	75	2.5	T 101 B	< 30	< 60	No	< 30	Yes	No	No	5	1	4932254061	4002395301522
											25	1	4932373489	4002395349296
	75	2.5	T 101 BF	< 30	< 60	No	< 30	Yes	No	No	5	1	4932373390	4002395348855
	75	4	T 101 D	< 50	< 60	No	< 45	Yes	No	No	5	1	4932274351	4002395301515
											25	1	4932373490	4002395349906
	105	3	T 301 CD	< 80	< 60	No	-	Yes	No	No	5	1	4932399306	4002395359202
	105	4	T 301 DL	< 80	< 80	No	< 50	Yes	No	No	5	1	4932346071	4002395312399

Precise straight cutting blades: kitchen worktops

The following blades benefit from a thicker blade body guaranteeing extra stiffness and consequently a more accurate vertical cut. Ideal for those applications where a true square cut is necessary - i.e. kitchen worktops.

	75	4	T 101 DP	< 60	< 60	No	< 45	Yes	No	No	5	1	4932373080	4002395346073
	105	4	T 101 DP sp.	< 80	< 80	No	< 50	Yes	No	No	5	1	4932373388	4002395348831

Special application: kitchen worktops and laminated chipboard

These blades have a reversed tooth design, this means that the blade cuts on the downward stroke making them extremely suitable for clean and splinter free cuts in laminated chipboard and especially kitchen worktops in situ.

For best results work without pendulum action.

	75	2.5	T 101 BR	< 30	< 60	No	< 60	Yes	No	No	5	1	4932346079	4002395312382
	105	2.5	T101BR sp.	< 50	< 80	No	< 80	Yes	No	No	5	1	4932348072	4002395313860

Special application: laminated and parquet flooring

Blade 4932373392 is ideally suited for cutting curves and irregular shapes. Use blade 4932373083 for straight cuts.

	50	1.35	T 101 A0	< 20	No	< 20	< 15	Yes	No	Yes	5	1	4932373392	4002395348879
	60	1.9	Special	3 - 20	Yes	Yes	-	Yes	No	No	5	1	4932373083	4002395346080

Jigsaw blades for metal



Traditional blades

Blade reference 4939274652 is especially suited to cutting very thin sheet material because of its low 0.7 mm tooth pitch. For those professionals desiring extra lifetime and durability we recommend the use of Bi-Metal blades in conjunction with a suitable cooling lubricant, the blades lifetime is double that of non Bi-Metal blades.

	Blade length (mm)	Tooth pitch (mm)	Ref. No.	METAL	Cu/Ni/Ms/Zn	WOOD	STAINLESS-STEEL INOXSTA	ALU	P.W.G.	PERSPEX		Pack quantity	Min. order quantity	Article Number	EAN Code
	55	0.7	T 118 G	0.5 - 2	0.5 - 2	-	-	-	-	-	No	5	1	4932274652	4002395301621
	55	1.2	T 118 A	1.5 - 4	1.5 - 4	-	-	-	-	-	No	5 25	1 1	4932254063 4932373486	4002395301614 4002395349265
Bi-Metal	55	1.2	T 118 AF	1.5 - 4	1.5 - 4	-	1.2 - 2	-	-	-	No	5	1	4932340011	4002395304684
	66	1.2	T 118 A sp.	1.5 - 4	1.5 - 4	-	-	-	-	-	No	5	1	4932345826	4002395313464
	105	1	T 318 A	1 - 4	1 - 4	< 85	-	-	-	-	No	5	1	4932399307	4002395359219
	55	2	T 118 B	3 - 6	3 - 6	-	-	3 - 10	-	-	No	5	1	4932254064	4002395301591
Bi-Metal	55	2	T 118 BF	3 - 6	3 - 6	-	2 - 3	3 - 10	-	2 - 30	No	5	1	4932340012	4002395304691
Bi-Metal	75	2.5	T 101 A sp.	-	2 - 10	< 45	-	3 - 10	-	2 - 20	No	5	1	4932274651	4002395301577

Universal application blades

These blades are suitable for cutting a wide variety of materials ranging from mild steel, aluminium, wood with nails, plastics and sandwich composites. Blade 4932373086 with its extra length (155 mm) is suitable for cutting thick corrugated sandwich material.

Bi-Metal TWIN CUT	91	2.5 / 1.8	T 123 XF	2.5 - 10	3 - 10	< 50	-	4 - 10	-	-	No	5	1	4932430142	4002395378036
Bi-Metal	105	1.2	T 318 AF	1.5 - 4	1.5 - 4	< 85	-	-	-	-	No	5	1	4932274654	4002395301607
Bi-Metal	105	2	T 318 BF	3 - 6	3 - 6	< 85	-	3 - 10	4 - 30	-	No	5	1	4932274653	4002395301584
Bi-Metal	155	1	T 718 AF	1 - 4	1 - 4	< 125	-	-	-	-	No	5	1	4932373086	4002395346097

Curve cutting blades

Especially narrower saw blade body allows one to cut tight curves in a range of metallic materials.

	55	1.2	T 218 A	1.5 - 4	1.5 - 4	-	-	-	-	-	Yes	5	1	4932346082	4002395312368
	75	3	T 227 D	3.5 - 6	3.5 - 6	-	-	4 - 15	4 - 30	-	Yes	5	1	4932346081	4002395312351

Special application: aluminium

Most traditional blades are also capable of cutting aluminium, however these two blades benefit from a larger tooth pitch and wider gullets offering better material removal which is an advantage when cutting aluminium.

When cutting curves or irregular shapes in aluminium we recommend the use of blade 4932346081.

Blade length (mm)	Tooth pitch (mm)	Ref. No.								Pack quantity	Min. order quantity	Article Number	EAN Code
75	3	T 127 D	3.5 - 6	3.5 - 6	-	-	4 - 15	4 - 30	5	1	4932274315	4002395301560	

Special application: stainless steel

This blades teeth consist of a carbide tipped strip making it the most suitable and durable blade for steels with a high alloy content such as stainless steel.

For best results work without pendulum action and use cutting oil as a lubricant.

50	1.1	T 118 AHM	1.5 - 3	1.5 - 3	-	1.5 - 3	-	-	2	1	4932373393	4002395348886	
50	1.4	T 118 EHM	2 - 5	2 - 5	-	2 - 5	-	-	2	1	4932373394	4002395348893	

Jigsaw blades for special materials

Special applications: fibreglass, reinforced plastics, acrylic glass

Blade 4932373387 has tungsten carbide teeth for longer lifetime in hard materials such as fibreglass.

Blade length (mm)	Tooth pitch (mm)	Ref. No.												Pack quantity	Min. order quantity	Article Number	EAN Code
75	2.5	T 101 A sp.	2 - 10	-	No	No	-	2 - 20	-	No	-	No	5	1	4932274651	4002395301577	
75	4.2	T 141 HM	-	-	No	No	5 - 20	-	5 - 20	No	-	Yes	1	1	4932399308	4002395359226	
105	4.2	T 341 HM	-	< 60	No	No	5 - 20	-	5 - 20	No	-	No	1	1	4932373387	4002395348824	

Special application: abrasive material and cast iron

54	Grain 30	T 130 Coarse grit	-	-	Yes	Yes	< 15	-	-	Yes	5 - 15	No	1	1	4932213231	4002395301645	
54	Grain 50	T 150 Fine	-	-	Yes	Yes	< 10	-	-	Yes	5 - 15	No	1	1	4932213232	4002395301652	

Special application: insulation material

Blade length (mm)	Tooth pitch (mm)	Ref. No.					Pack quantity	Min. order quantity	Article Number	EAN Code
155	Wave knife	T 313 AW	Yes	Yes	Yes	Yes	5	1	4932430144	4002395378050

Jigsaw blade sets - T-Shank reception

Description	Pack quantity	Min. order quantity	Article Number	EAN Code
5 pc set on blister card. Suitable for applications in wood and metal.	5	1	4932345825	4002395314850
Jigsaw blade 4932213116, 4932254061, 4932254063, 4932254064, 4932254071.				



System accessories - Jigsaws

Description	HD18 JS/JSB BST 18 X Li JS 120 x JSPE 135 TX STEP 1200 BX/X JSPE 90 X FSPE 11 X BSPE 110 QX STEP 800 X ST 800 XE V28 JSB	STEP 70 STEP 75 ST 700 E STEP 90 X STEP 100 X FSPE 100 XL BSPE 100 XL	Pack quantity	Min. order quantity	Article Number	EAN Code
① Gliding shoe for materials with delicate surfaces.	•		1	1	4932430356	4002395380176
	•		1	1	4932430834	4002395384969



U Shank jigsaw blades

Blade length (mm)	Tooth pitch (mm)	Ref. No.							Pack quantity	Min. order quantity	Article Number	EAN Code
75	4	A 2202	5 - 60	< 60	-	No	Yes	Yes	5	1	4932354508	4002395321070
75	2.5	A5035/A5041	< 30	< 60	< 30	Yes	No	No	5	1	4932354506	4002395321056

Multitool accessories

Universal blade reception makes Milwaukee® blades compatible with the most popular osculating tools.

Description	Teeth per inch	Width (mm)	Length (mm)	Pack quantity	Min. order quantity	Article Number	EAN Code
① 19 mm plunge cut blade. Plunge / recess / flush cutting in wood and PVC.	16	19	42	1	1	48900015	045242349005
				10	1	48904015	045242475148
② 32 mm plunge cut blade. Plunge / recess / flush cutting in wood and PVC.	16	32	42	1	1	48900030	045242349036
				10	1	48904030	045242468539
③ 32 mm fast cut Japanese tooth blade. For fast, clean cuts in soft and hard wood.	14	32	42	1	1	48900055	045242355228
				10	1	48904055	045242475155
④ 64 mm Bi-Metal wide blade. For cuts in sheet metal, nail embedded wood, plastic and fibreglass.	18	64	42	1	1	48900050	045242353514
				10	1	48904050	045242468553
⑤ 80 mm flush cut segmented blade. For accurate and flush cuts in wood and plastics.	18	80	20	1	1	48900045	045242349067
⑥ 80 mm Titanium flush segmented blade. Titanium coating for best wear resistance and double the lifetime. For accurate and flush cuts in sheet metal, nail embedded wood, plastic and fibreglass.	18	80	20	1	1	48900035	045242349043
⑦ Grout removal blade. For removing damaged grout between wall or floor tiles. Also good for cutting grooves in drywall.	Carbide grit	64		1	1	48900100	045242349074
⑧ Flush cut carbide grit blade. For cutting grooves and slots in plaster, drywall and grout.	Carbide grit	30	20	1	1	48900110	045242349081
Multitool blade 9 pc set							
⑨ 2x 19 mm plunge cut blade, 2x 32 mm plunge cut blade, 1x 32 mm fast cut Japanese tooth blade, 2x 64 mm Bi-Metal wide blade, 1x 80 mm flush cut segmented blade, 1x grout removal blade				9	1	48901009	045242474721
⑩ Sanding pad		93	93	1	1	48902000	045242349098
	Grit						
	60	93	93	8	1	48902060	045242349166
⑪ Sanding paper. Hook & Loop. 8 pc pack.	80	93	93	8	1	48902080	045242349173
	120	93	93	8	1	48902120	045242349135
	240	93	93	8	1	48902240	045242366064



Circular saw blades for wood

Circular saw blades for portable tools

Blade diameter (mm)	Bore size (mm)	No. of teeth	Cutting width (kerf) (mm)	Material compatibility										Pack quantity	Min. order quantity	Article Number	EAN Code	
				Solid wood	Chipboard	MDF and fibreboard	Laminated chipboard	Blockboard	Plywood & OSB boards	Plastics	Plasterboard, breezeblock, cemented plywood	Non ferrous metals profiles alu	Fine cut					
160	20	12	2.4	✓	✓	✓									1	1	4932327743	4002395312962
		48	2.6	✓	✓	✓	✓	✓	✓	✓					1	1	4932248233	4002395307340
		42	2.8	✓	✓		✓	✓	✓	✓	✓				1	1	4932346511	4002395318933
165	30	24	1.8	✓	✓	✓	✓	✓	✓	✓	✓			1	1	4932399909	4002395365647	
		36	2.6	✓	✓	✓	✓	✓	✓	✓	✓		✓	1	1	4932352133	4002395367863	
184	30	24	1.8	✓	✓	✓	✓	✓	✓	✓	✓			1	1	4932352327	4002395369867	
		48	1.8	✓	✓	✓	✓	✓	✓	✓	✓		✓	1	1	4932352328	4002395369874	
		54	2.0	✓	✓	✓	✓	✓	✓	✓	✓	✓	✓	1	1	4932352329	4002395369881	
190	30	16	2.4	✓	✓	✓								1	1	4932256387	4002395300709	
		24	2.4	✓	✓	✓	✓	✓	✓	✓	✓			1	1	4932327969	4002395319060	
		48	2.8	✓	✓	✓	✓	✓	✓	✓	✓		✓	1	1	4932256388	4002395300747	
		54	2.8	✓	✓		✓	✓	✓	✓	✓	✓	✓	1	1	4932346512	4002395318940	
210	30	16	2.4	✓	✓	✓								1	1	4932259182	4002395300716	
		48	2.8	✓	✓	✓	✓	✓	✓	✓	✓		✓	1	1	4932259136	4002395300754	
		54	2.8	✓	✓		✓	✓	✓	✓	✓	✓	✓	1	1	4932346513	4002395318957	
230	30	48	3.0	✓	✓	✓	✓	✓	✓	✓			1	1	4932303099	4002395305285		
235	30	24	2.6	✓	✓	✓								1	1	4932451725	4002395279326	
		40	2.6	✓	✓	✓	✓	✓	✓	✓	✓		✓	1	1	4932451726	4002395279333	
		60	2.6	✓	✓	✓	✓	✓	✓	✓	✓		✓	1	1	4932451727	4002395279340	

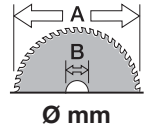

Circular saw blades for cordless tools

140	20	18	1.3	✓	✓	✓	✓	✓	✓					1	1	4932430719	4002395383801
165	20	24	2.6	✓	✓	✓	✓	✓	✓	✓	✓			1	1	4932352131	4002395367849
165	20	52	2.8	✓	✓	✓	✓	✓	✓	✓	✓			1	1	4932352132	4002395367856
165	15.87	24	1.6	✓	✓	✓	✓	✓	✓					1	1	4932352313	4002395369720
165	15.87	40	1.6	✓	✓	✓	✓	✓	✓					1	1	4932352314	4002395369737
190	30	24	2.0	✓	✓	✓	✓	✓	✓					1	1	4932430430	4002395380916

Circular saw blades for mitre saws

190	30	40	2.8	✓	✓	✓	✓	✓	✓					1	1	4932459544	4058546027162
		24	2.8	✓	✓	✓	✓	✓	✓					1	1	4932352135	4002395367887
210	30	48	2.8	✓	✓	✓	✓	✓	✓					1	1	4932352136	4002395367894
		54	2.8							✓	✓	✓		1	1	4932352137	4002395367900
216	30	24	2.8	✓	✓	✓	✓	✓	✓					1	1	4932352839	4002395374977
		48	2.4	✓	✓	✓	✓	✓	✓					1	1	4932430720	4002395383818
		48	2.8	✓	✓	✓	✓	✓	✓					1	1	4932352840	4002395374984
		80	2.8	✓	✓	✓	✓	✓	✓	✓	✓	✓		1	1	4932352841	4002395374991
250	30	24	3.2	✓	✓	✓	✓	✓	✓					1	1	4932352138	4002395367917
		48	3.2	✓	✓	✓	✓	✓	✓					1	1	4932352139	4002395367924
		80	3.2	✓	✓	✓	✓	✓	✓					1	1	4932361504	4002395337088
		80	3.4							✓	✓	✓		1	1	4932352140	4002395367931
254	30	60	2.4	✓	✓	✓	✓	✓	✓					1	1	4932451728	4002395279357
		60	3.2	✓	✓	✓	✓	✓	✓					1	1	4932352141	4002395367948
305	30	100	3.2	✓	✓	✓	✓	✓	✓					1	1	4932352142	4002395367955
		96	3.2							✓	✓	✓		1	1	4932352143	4002395367962

Circular saw blades for metal

1. Engineered tooth geometry for optimum performance.
2. Top grade carbide and cermet tooth tips for superior lifetime.
3. Fully hardened and tensioned blade body for accurate cuts.
4. Deep gullets provide rapid and efficient chip removal.
5. Laser cut resin filled expansion slots for noise and vibration dampening.

- Cuts clean. Burr free edges reduce extra finishing processes.
- Cuts cool. The cut material can be handled immediately after cutting.
- Cuts fast. Quicker than all other conventional cutting methods.
- Cost cutter. Less expensive per cut than abrasive discs.
- Reduced noise.
- Reduced vibration.
- Total safety: no sparks, no coolants, cool to touch.

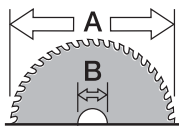

Blade diameter (mm)	Bore size (mm)	No. of teeth	Cutting width (kerf) (mm)	Material wall thickness (mm)	Mild steel	Sheet steel up to 2.5mm	Corrugated steel panels up to 2.5mm	Steel tube	Steel pipe	Angle iron	Steel channel	Stainless steel sheets	Cast iron	Copper	Aluminium	Rebar	Sandwich material (steel, foam, panels)	Pack quantity	Min. order quantity	Article Number	EAN Code
135	20	30	1.6	1-2.5	✓	✓	✓	✓	✓	✓	✓	✖	✖	✖	✖	✓	1	1	48404070	045242233786	
		50	1.6	1-2.5	✖	✖	✖	✖	✖	✖	✖	✖	✖	✓	✓	✖	✖	1	1	48404075	045242233793
150	20	34	1.6	1-2.5	✓	✓	✓	✓	✓	✓	✓	✖	✖	✖	✖	✓	1	1	48404080	045242510283	
165	15.87	48	1.6	1-2.5	✓	✓	✓	✓	✓	✓	✓	✖	✖	✖	✖	✓	1	1	48404015	045242134298	
174	20	36	1.65	>2.5	✓	✖	✖	✓	✓	✓	✓	✖	✖	✖	✖	✖	1	1	48404016	045242134120	
		50	1.65	1-2.5	✓	✓	✓	✓	✓	✓	✓	✖	✖	✖	✖	✓	1	1	48404017	045242151738	
203	15.87	42	1.8	>2.5	✓	✖	✖	✓	✓	✓	✓	✖	✖	✖	✖	✖	1	1	48404515	045242134465	
		50	1.8	1-2.5	✓	✓	✓	✓	✓	✓	✓	✖	✖	✖	✖	✓	1	1	48404520	045242134472	

✓ Most suitable. Recommended for these materials.

◆ Suitable. Recommended for intermittent use in these materials.

Very good cutting characteristics, but greatly reduced lifetime of the blade.

✖ Not suitable. Not recommended for these materials.

Optimising Blade Life

1. Clamp the workpiece securely to avoid vibration.
2. Do NOT stack or bundle cutting material. The gaps between layers allow for more opportunities to chip the teeth.
The life of the blade is severely affected by this type of cutting.
3. Lower the blade to its maximum cutting capacity and allow the tool to come to full speed before applying the blade to the material.
4. Do NOT force the saw blade into the material. Start gently, then gradually apply enough pressure to avoid sparks.
5. Optimal cutting speed and pressure will produce little or no sparks. Sparking creates heat build up which shortens saw blade life.
6. Keep the cut straight. If following a cut line and you wander off the line, getting back on line may cause side loading of the blade and break teeth. Use an edge guide whenever possible.
7. Do NOT apply side pressure on the blade as this will cause chipping of the teeth.
8. Periodically allow the tool to run free of the cutting material to cool the blade and tool especially when making long cuts or cuts in thick material.

Circular saw blades for table saws

NEW

Diameter (mm)	Bore size (mm)	No. of teeth	Cutting width (kerf) (mm)	Solid wood	Chipboard	MDF and fibreboard	Laminated chipboard	Blockboard	Plywood & OSB boards	Plastics	Plasterboard, breezeblock, cemented plywood	Non ferrous metals profiles alu	Fine cut	Pack quantity	Min. order quantity	Article Number	EAN Code
210	30	24	2.6	✓	✓	✓	✓	✓	✓					1	1	4932464174	4058546221195

System accessories - Circular saws

Description	Fits circular saws	Pack quantity	Min. order quantity	Article Number	EAN Code
① Clean line system.	SCS 65 Q,CS 55	3	1	4932346123*	4002395313266
② Cloth filter bag. Requires bag holder 4932346123.	SCS 65 Q,CS 55	1	1	4932346182*	4002395313273
Dust absorption connector.	PCS 55	1	1	4932369282	4002395338412
	CS 75,HKS 75,HK 75 A	1	1	4932259301*	4002395304158
③ Extension hose Ø 35 mm / 4 m long. Requires adaptor (362778).	CS 55,CS 75,HKS 75, HK 75 A,HKS 85	1	1	4932330552	4002395312719
④ Extraction hose Ø 26 mm, 4 m. For connection to external extraction system.	PCS 55,HK 46 N	1	1	4932278824	4002395308286
Spanner for removing saw blade.	CS 55,HK 46 N,SCS 65 Q, CS 75,PCS 55,HKS 75, HK 75 A,HKS 85,PMS 18	1	1	4932371469	4002395342181
	CS 75,CS 55,HKS 75,HK 75 A	1	1	4932276288	4002395308217
Parallel guide / fence.	PMS 18	1	1	49221001	045242180417
	SCS 65 Q	1	1	49224146	045242181896
Plastic transport case.	SCS 65 Q	1	1	201672001	4002395840519
⑤ Dust extraction hood for MS216 Mitre Saw.		1	1	4932430005	4002395376667
Guide rail GRU 1400.					
⑥ 1400 mm long. Supplied with carry bag.	CS85CBE	1	1	4932451265	4002395170197
Connector Piece		1	1	4932352559	4002395372171
For fixing guide rail to the work material.		1	1	4932451266	4002395170807
Strip and rubber lip assembly set.		1	1	4931433774	4002395887620



Planer blades

Description	Width (mm)	Fits planers	Pack quantity	Min. order quantity	Article Number	EAN Code
Tungsten carbide reversible blades. Two reversible blades, suitable for soft and hardwoods.	82 mm	H 500,H 750	2	1	4932273484	4002395300150
	102 mm	HB 750,HBE 800	2	1	4932316243	4002395300167



System accessories - Planers

Description	All planers 82 & 102mm	Pack quantity	Min. order quantity	Article Number	EAN Code
Hose connections. Suction sleeve for suction hoses 330552.	✓	1	1	4932316270	4002395302017
Parallel guide.	✓	1	1	4932274071	4002395300358
Folding rebate depth gauge. For all planers except H500 / PR 1.6-82 models.	✓	1	1	4932274069	4002395300129

Bandsaw blades

Choosing the right tooth geometry

10 Tpi Tooth pitch 2.5 mm	10/14 Tpi Tooth pitch 2.5/1.8 mm	14 Tpi Tooth pitch 1.8 mm	14/18 Tpi Tooth pitch 1.8/1.4 mm	18 Tpi Tooth pitch 1.4 mm	25 Tpi Tooth pitch 1 mm
FOR CUTTING STOCK 8 to 13 mm	FOR CUTTING STOCK 5 to 13 mm	FOR CUTTING STOCK 5 to 8 mm	FOR CUTTING STOCK 4 to 8 mm	FOR CUTTING STOCK 4 to 5 mm	FOR CUTTING STOCK < 4 mm

Bi-Metal blades with matrix II high speed steel teeth with 8% cobalt outlast conventional blades up to 3 times, requiring fewer blade changes.

Extremely hard and uniform tooth point is electron beam welded to a tough durable backing with high flex life for faster cutting, and longer blade life.

High speed cutting of aluminium, angle iron, bronze, brass, copper, galvanized pipe, mild steel.

Tougher steels including stainless, chrome, tungsten steel plus other problem materials at slow speed.



Bandsaw blade 1139.83 mm blade length (corded & M18 FUEL[™])

Material wall thickness (mm)	Tooth pitch (mm)	Teeth per inch	Pack quantity	Min. order quantity	Article Number	EAN Code
≥ 8	2.5	10	3	1	48390501	045242132096
5 - 8	1.8	14	3	1	48390511	045242132164
4 - 5	1.4	18	3	1	48390521	045242132263
≤ 4	1.0	25	3	1	48390531	045242132362

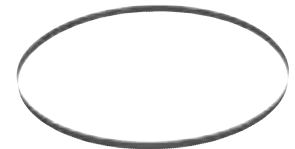

Bandsaw blade 898.52 mm blade length (M18)

Material wall thickness (mm)	Tooth pitch (mm)	Teeth per inch	Pack quantity	Min. order quantity	Article Number	EAN Code
5 - 8	1.8	14	3	1	48390519	045242201594
4 - 5	1.4	18	3	1	48390529	045242201747
≤ 4	1.0	25	3	1	48390539	045242201815



Bandsaw blade 687.57 mm blade length (M12)

Material wall thickness (mm)	Tooth pitch (mm)	Teeth per inch	Pack quantity	Min. order quantity	Article Number	EAN Code
2.5 - 8	1.4	18	3	1	48390572	045242272341



Bandsaw Bi-Metal multi-pitch blades

Designed with varying set angles and gullet depths to break up the harmonic vibrations generated in cutting, resulting in smoother, quieter cutting and longer blade life.

Designed for interrupted cutting applications (tubing, structurals, etc.).







Also production cutting of solids in variety of sizes or shapes.

Blade length 1139.83 mm







Material wall thickness (mm)	Tooth pitch (mm)	Teeth per inch	Pack quantity	Min. order quantity	Article Number	EAN Code
5 - 13	2.5 / 1.8	10 / 14	3	1	48390551	045242132461
4 - 8	1.8 / 1.4	14 / 18	3	1	48390561	045242132560



Press jaws

Jaw profile	Fits to following pipe systems suppliers	Nominal size	Tool suitability	Jaw model description	Id. No. 4932	EAN Code 4002395			
M	Geberit: Mapress VSH: X-Press Eurotubi Raccorderie Metallique Rubinetteria Bresciane Sanha: Nirosoan Pegler Yorkshire	M12	M12	J12-M12	430243	379040			 Jaw M profile  Ring jaw M profile
		M12	M18	J18-M12	430244	379057			
		M15	M12	J12-M15	430245	379064			
		M15	M18	J18-M15	430246	379071			
		M18	M12	J12-M18	430247	379088			
		M18	M18	J18-M18	430248	379095			
		M22	M12	J12-M22	430249	379101			
		M22	M18	J18-M22	430250	379118			
		M28	M12	J12-M28	430251	379125			
		M28	M18	J18-M28	430252	379132			
		M35	M12	J12-M35	430253	379149			
		M35	M18	J18-M35	430254	379156			
		M42	M18	RJ18-M42 (requires ring jaw adaptor RJA-1)	430255	379163			
		M54	M18	RJ18-M54 (requires ring jaw adaptor RJA-1)	430256	379170			
V	Viega Comap IBP Sanha: Nirosoan	V12	M12	J12-V12	430260	379217			 Jaw V profile  Ring jaw V profile
		V12	M18	J18-V12	430261	379224			
		V15	M12	J12-V15	430262	379231			
		V15	M18	J18-V15	430263	379248			
		V18	M12	J12-V18	430264	379255			
		V18	M18	J18-V18	430265	379262			
		V22	M12	J12-V22	430266	379279			
		V22	M18	J18-V22	430267	379286			
		V28	M12	J12-V28	430268	379293			
		V28	M18	J18-V28	430269	379309			
		V35	M12	J12-V35	430270	379316			
		V35	M18	J18-V35	430271	379323			
		V42	M18	RJ18-V42 (requires ring jaw adaptor RJA-1)	430272	379330			
		V54	M18	RJ18-V54 (requires ring jaw adaptor RJA-1)	430273	379347			
TH	ALB Comap Fränkische Henco Sanha Tiemme (TH14 - TH25 only)	TH14	M12	J12-TH14	430274	379354			 Jaw TH profile  Ring jaw TH profile
		TH14	M18	J18-TH14	430275	379361			
		TH16	M12	J12-TH16	430276	379378			
		TH16	M18	J18-TH16	430277	379385			
		TH18	M12	J12-TH18	430278	379392			
		TH18	M18	J18-TH18	430279	379408			
		TH20	M12	J12-TH20	430280	379415			
		TH20	M18	J18-TH20	430281	379422			
		TH25	M12	J12-TH25	430282	379439			
		TH25	M18	J18-TH25	430355	380169			
		TH26	M12	J12-TH26	430283	379446			
		TH26	M18	J18-TH26	430284	379453			
		TH32	M12	J12-TH32	430285	379460			
		TH32	M18	J18-TH32	430286	379477			
		TH40	M12	J12-TH40	430287	379484			
		TH40	M18	RJ18-TH40 (requires ring jaw adaptor RJA-1)	430288	379491			
		TH50	M18	RJ18-TH50 (requires ring jaw adaptor RJA-1)	430289	379507			
		TH63	M18	RJ18-TH63 (requires ring jaw adaptor RJA-1)	430290	379514			

Press jaws

Jaw profile	Fits to following pipe systems suppliers	Nominal size	Tool suitability	Jaw model description	Id. No. 4932	EAN Code 4002395			
U	ALB Uponor: Unipipe, Airpipe Kann: Kann-therm Wavin: Press-Systeme Fränkische: Alpex F50 Profi DW Verbundrohr: Multitubo IBP: >B< Flex KE Kelit: Kelit Kelox Jupiter: Heizsystem	U14	M12	J12-U14	430291	379521			  Jaw U profile  Ring jaw U profile
		U14	M18	J18-U14	430292	379538			
		U16	M12	J12-U16	430293	379545			
		U16	M18	J18-U16	430294	379552			
		U18	M12	J12-U18	430295	379569			
		U18	M18	J18-U18	430296	379576			
		U20	M12	J12-U20	430297	379583			
		U20	M18	J18-U20	430298	379590			
		U25	M12	J12-U25	430299	379606			
		U25	M18	J18-U25	430300	379613			
		U32	M12	J12-U32	430301	379620			
		U32	M18	J18-U32	430302	379637			
		U40	M12	J12-U40	430303	379644			
		U40	M18	RJ18-U40 (requires ring jaw adaptor RJA-1)	430304	379651			
U50	M18	RJ18-U50 (requires ring jaw adaptor RJA-1)	430305	379668					
U63	M18	RJ18-U63 (requires ring jaw adaptor RJA-1)	430306	379675					
ACz	ACOME MT	Acz12	M12	J12-ACz 12	459388	4058546010492			
		Acz16	M12	J12-ACz 16	459389	4058546010508			
		Acz20	M12	J12-ACz 20	459390	4058546010515			
		Acz25	M12	J12-ACz 25	459391	4058546010522			
G	Geberit: Mepla & Mepla Therm	G16	M12		464217	4058546221621			
		G20	M12		464218	4058546221638			
		G26	M12		464219	4058546221645			
		G32	M12		464220	4058546221652			
		G40	M12		464221	4058546221669			
① Ring jaw adaptor				RJA-1	430307	379682		①  Ring jaw adaptor	

Crimping dies for M18 HCCT

Type	Form	Cable lug size (mm ²)	Imprint code	Description	Pack quantity	Min. order quantity	Article Number	EAN Code
① NF C 20-130 for copper compression cable lugs.	Hex	16	16	NF22 Cu 16	1	1	4932451733	4002395276837
		25	25	NF22 Cu 25	1	1	4932451734	4002395276844
		35	35	NF22 Cu 35	1	1	4932451735	4002395276851
		50	50	NF22 Cu 50	1	1	4932451736	4002395276868
		70	70	NF22 Cu 70	1	1	4932451737	4002395276875
		95	95	NF22 Cu 95	1	1	4932451738	4002395276882
		120	120	NF22 Cu 120	1	1	4932451739	4002395276899
		150	150	NF22 Cu 150	1	1	4932451740	4002395277506
		185	185	NF22 Cu 185	1	1	4932451741	4002395277513
		240	240	NF22 Cu 240	1	1	4932451742	4002395277520
② DIN 46235 for copper compression cable lugs and connectors (DIN 46267)	Hex	16	8	DIN22 Cu 16	1	1	4932451744	4002395277551
		25	10	DIN22 Cu 25	1	1	4932451745	4002395277568
		35	12	DIN22 Cu 35	1	1	4932451746	4002395277575
		50	14	DIN22 Cu 50	1	1	4932451747	4002395277582
		70	16	DIN22 Cu 70	1	1	4932451748	4002395277599
		95	18	DIN22 Cu 95	1	1	4932451749	4002395278206
		120	20	DIN22 Cu 120	1	1	4932451750	4002395278213
		150	22	DIN22 Cu 150	1	1	4932451751	4002395278220
		185	25	DIN22 Cu 185	1	1	4932451752	4002395278237
		240	28	DIN22 Cu 240	1	1	4932451753	4002395278244
③ Tubular cable lugs and connectors.	Hex	16	16	R22 Cu 16	1	1	4932451755	4002395278268
		25	25	R22 Cu 25	1	1	4932451756	4002395278275
		35	35	R22 Cu 35	1	1	4932451757	4002395278282
		50	50	R22 Cu 50	1	1	4932451758	4002395278299
		70	70	R22 Cu 70	1	1	4932451759	4002395278909
		95	95	R22 Cu 95	1	1	4932451760	4002395278916
		120	120	R22 Cu 120	1	1	4932451761	4002395278923
		150	150	R22 Cu 150	1	1	4932451762	4002395278930
		185	185	R22 Cu 185	1	1	4932451763	4002395278947
		240	240	R22 Cu 240	1	1	4932451764	4002395278954
④ Copper solderless terminals (DIN 46234, DIN 46230, DIN 46341)	Half round indent	16	16	Q22 CU 16	1	1	4932451766	4002395278978
		25	25	Q22 CU 25	1	1	4932451767	4002395278985
		35	35	Q22 CU 35	1	1	4932451768	4002395278992
		50	50	Q22 CU 50	1	1	4932451769	4002395279609
		70	70	Q22 CU 70	1	1	4932451770	4002395279616
⑤ DIN Aluminium for aluminium compression cable lugs and connectors (DIN 46329, 46267 Part 1 and 2, DIN EN 50182)	Hex	16/25	12	DIN22 AL 16/25	1	1	4932451771	4002395279623
		35	14	DIN22 AL 35	1	1	4932451772	4002395279630
		50	16	DIN22 AL 50	1	1	4932451773	4002395279647
		70	18	DIN22 AL 70	1	1	4932451774	4002395279654
		95/120	22	DIN22 AL 95/120	1	1	4932451775	4002395279661
		150	25	DIN22 AL 150	1	1	4932451776	4002395279678
		185	28	DIN22 AL 185	1	1	4932451777	4002395279685
240	32	DIN22 AL 240	1	1	4932451778	4002395279692		
⑥ Pre rounding of triangular shaped aluminium and copper conductors.	Round	300	34	DIN22 AL 300	1	1	4932451779	4002395276905
		16	-	RU22 Cu/Al 16	1	1	4932451780	4002395276912
		35/25	-	RU22 Cu35/AL25	1	1	4932451781	4002395276929
		50/35	-	RU22 Cu50/AL35	1	1	4932451782	4002395276936
		70/50	-	RU22 Cu70/AL50	1	1	4932451783	4002395276943
		95/70	-	RU22 Cu95/AL70	1	1	4932451784	4002395276950
		120/95	-	RU22 Cu120/AL95	1	1	4932451785	4002395276967
		150/120	-	RU22 Cu150/AL120	1	1	4932451786	4002395276974
		185/150	-	RU22 Cu185/AL150	1	1	4932451787	4002395276981
		240/185	-	RU22 Cu240/AL185	1	1	4932451788	4002395276998
300/240	-	RU22 Cu300/AL240	1	1	4932451789	4002395277605		
⑦ Crimping die box					1	1	4932459339	4058546010003

①



②



③



④



⑤



⑥



⑦



Crimping dies for M18 HCCT 109/42

NEW

Type	Form	Cable lug size (mm ²)	Imprint code	Description	Pack quantity	Min. order quantity	Article Number	EAN Code		
① NF C 20-130 for copper compression cable lugs	Hex	16	16	NF13 Cu 16	1	1	4932459453	4058546011147		
		25	25	NF13 Cu 25	1	1	4932459454	4058546011154		
		35	35	NF13 Cu 35	1	1	4932459455	4058546011161		
		50	50	NF13 Cu 50	1	1	4932459456	4058546011178		
		70	70	NF13 Cu 70	1	1	4932459457	4058546011185		
		95	95	NF13 Cu 95	1	1	4932459458	4058546011192		
		120	120	NF13 Cu 120	1	1	4932459459	4058546011208		
		150	150	NF13 Cu 150	1	1	4932459460	4058546011215		
		185	185	NF13 Cu 185	1	1	4932459461	4058546011222		
		240	240	NF13 Cu 240	1	1	4932459462	4058546011239		
		300	300	NF13 Cu 300	1	1	4932459463	4058546011246		
② DIN 46235 for copper compression cable lugs and connectors (DIN 46267)	Hex	16	8	DIN13 Cu 16	1	1	4932459465	4058546011260		
		25	10	DIN13 Cu 25	1	1	4932459466	4058546011277		
		35	12	DIN13 Cu 35	1	1	4932459467	4058546011284		
		50	14	DIN13 Cu 50	1	1	4932459468	4058546011291		
		70	16	DIN13 Cu 70	1	1	4932459469	4058546011307		
		95	18	DIN13 Cu 95	1	1	4932459470	4058546011314		
		120	20	DIN13 Cu 120	1	1	4932459471	4058546011321		
		150	22	DIN13 Cu 150	1	1	4932459472	4058546011338		
		185	25	DIN13 Cu 185	1	1	4932459473	4058546011345		
		240	28	DIN13 Cu 240	1	1	4932459474	4058546011352		
		300	32	DIN13 Cu 300	1	1	4932459475	4058546011369		
③ Tubular cable lugs and connectors	Hex	16	16	R13 Cu 16	1	1	4932459494	4058546011550		
		25	25	R13 Cu 25	1	1	4932459495	4058546011567		
		35	35	R13 Cu 35	1	1	4932459496	4058546011574		
		50	50	R13 Cu 50	1	1	4932459497	4058546011581		
		70	70	R13 Cu 70	1	1	4932459498	4058546011598		
		95	95	R13 Cu 95	1	1	4932459499	4058546011604		
		120	120	R13 Cu 120	1	1	4932459500	4058546011611		
		150	150	R13 Cu 150	1	1	4932459501	4058546011628		
		185	185	R13 Cu 185	1	1	4932459502	4058546011635		
		240	240	R13 Cu 240	1	1	4932459503	4058546011642		
		300	300	R13 Cu 300	1	1	4932459504	4058546026769		
④ Copper solderless terminals (DIN 46234, DIN 46230, DIN 46341)	Half round indent	16	16	Q13 CU 16	1	1	4932459477	4058546011383		
		25	25	Q13 CU 25	1	1	4932459478	4058546011390		
		35	35	Q13 CU 35	1	1	4932459479	4058546011406		
		50	50	Q13 CU 50	1	1	4932459480	4058546011413		
		70	70	Q13 CU 70	1	1	4932459481	4058546011420		
⑤ DIN Aluminium for aluminium compression cable lugs and connectors (DIN 46329, 46267 Part 1 und 2, DIN EN 50182)	Hex	16/25	12	DIN13 AL 16/25	1	1	4932459506	4058546026783		
		35	14	DIN13 AL 35	1	1	4932459507	4058546026790		
		50	16	DIN13 AL 50	1	1	4932459508	4058546026806		
		70	18	DIN13 AL 70	1	1	4932459509	4058546026813		
		95/120	22	DIN13 AL 95/120	1	1	4932459510	4058546026820		
		150	25	DIN13 AL 150	1	1	4932459511	4058546026837		
		185	28	DIN13 AL 185	1	1	4932459512	4058546026844		
		240	32	DIN13 AL 240	1	1	4932459513	4058546026851		
		300	34	DIN13 AL 300	1	1	4932459514	4058546026868		
		⑥ Pre rounding of triangular shaped aluminium and copper conductors	Round	16	-	RU13 Cu/Al16	1	1	4932459483	4058546011444
				35/25	-	RU13 Cu35/AL25	1	1	4932459484	4058546011451
50/35	-			RU13 Cu50/AL35	1	1	4932459485	4058546011468		
70/50	-			RU13 Cu70/AL50	1	1	4932459486	4058546011475		
95/70	-			RU13 Cu95/AL70	1	1	4932459487	4058546011482		
120/95	-			RU13 Cu120/AL95	1	1	4932459488	4058546011499		
150/120	-			RU13 Cu150/AL120	1	1	4932459489	4058546011505		
185/150	-			RU13 Cu185/AL150	1	1	4932459490	4058546011512		
240/185	-			RU13 Cu240/AL185	1	1	4932459491	4058546011529		
300/240	-			RU13 Cu300/AL240	1	1	4932459492	4058546011536		
400/300	-			RU13 Cu400/AL300	1	1	4932459493	4058546011543		

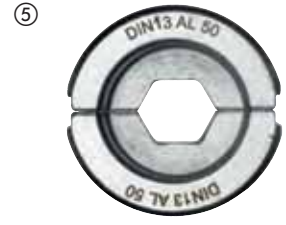
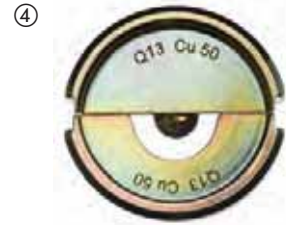
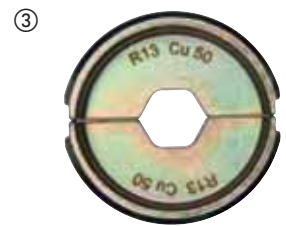
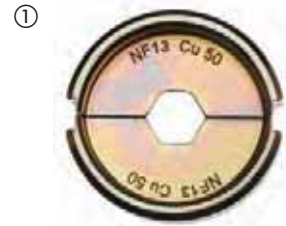

Crimping dies for M18 HCCT 109/42

NEW

Type	Form	Cable lug size (mm ²)	Imprint code	Description	Pack quantity	Min. order quantity	Article Number	EAN Code
① Ferruls	Trapezoid	16	-	AEH13 Cu 16	1	1	4932459515	4058546026875
		25	-	AEH13 Cu 25	1	1	4932459516	4058546026882
		35	-	AEH13 Cu 35	1	1	4932459517	4058546026899
		50	-	AEH13 Cu 50	1	1	4932459518	4058546026905
		70	-	AEH13 Cu 70	1	1	4932459519	4058546026912
		95	-	AEH13 Cu 95	1	1	4932459520	4058546026929
		120	-	AEH13 Cu 120	1	1	4932459521	4058546026936
		150	-	AEH13 Cu 150	1	1	4932459522	4058546026943
		185	-	AEH13 Cu 185	1	1	4932459523	4058546026950
		240	-	AEH13 Cu 240	1	1	4932459524	4058546026967
② C taps	Oval	16	-	C13 Cu 16	1	1	4932459525	4058546026974
		25	-	C13 Cu 25	1	1	4932459526	4058546026981
		35	-	C13 Cu 35	1	1	4932459527	4058546026998
		50	-	C13 Cu 50	1	1	4932459528	4058546027001
		70	-	C13 Cu 70	1	1	4932459529	4058546027018
		10	-	C13 Cu 10	1	1	4932459530	4058546027025
		10-35	-	C13 Cu 10-35	1	1	4932459531	4058546027032
		25-50	-	C13 Cu 25-50	1	1	4932459532	4058546027049
③ H clamps	Oval	35-70	-	C13 Cu 35-70	1	1	4932459533	4058546027056
		70	-	HAH13 Cu 70	1	1	4932459534	4058546027063
④ Double press cable shoes	Oval	95	-	HAH13 Cu 95	1	1	4932459535	4058546027070
		120	-	HAH13 Cu 120	1	1	4932459536	4058546027087
		2x50	-	DP13 Cu 2x50	1	1	4932459537	4058546027094
⑤ Crimping die box for M18 HCCT109/42 crimper (dies to be bought separately)	Oval	2x70	-	DP13 Cu 2x70	1	1	4932459538	4058546027100
		2x95	-	DP13 Cu 2x95	1	1	4932459539	4058546027117

①



②

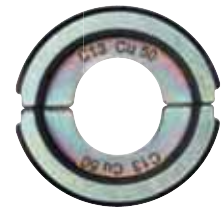

③



④



⑤



System accessories - Knockout punch and dies

- Suitable for mild steel and aluminium up to a thickness of 3 mm.
- Also suitable for stainless steel max. 2.5 mm.



Diameter (mm)	Standard PG size	Standard ISO metric size	Pack quantity	Min. order quantity	Article Number	Punch		Die	
						Article Number	EAN Code	Article Number	EAN Code
16.2		M 16	1	1	4932430841	4002395385034	4932430913	4002395385751	
20.4	PG 13.5	M 20	1	1	4932430842	4002395385041	4932430914	4002395385768	
22.5	PG 16 1/2"		1	1	4932430843	4002395385058	4932430915	4002395385775	
25.4		M 25	1	1	4932430844	4002395385065	4932430916	4002395385782	
28.3	PG 21 3/4"		1	1	4932430845	4002395385072	4932430917	4002395385799	
32.5		M 32	1	1	4932430846	4002395385089	4932430918	4002395385805	
40.5		M 40	1	1	4932430847	4002395385096	4932430919	4002395385812	
50.5		M 50	1	1	4932430848	4002395385102	4932430920	4002395385829	
63.5		M 63	1	1	4932430849	4002395385119	4932430921	4002395385836	

Draw stud bolt 49162680 (for 16.2 and 20.4 mm) Ø 11,1 mm: requires pre-drilling with Ø 11.3 - 11.5 mm drill bit / step drill.

Draw stud bolt 49162681 Ø 19 mm: requires pre-drilling with Ø 19.5 - 20 mm drill bit / step drill.

Description	Pack quantity	Min. order quantity	Article Number	EAN Code
Adaptor to allow the Milwaukee® tool to use competitors punches and dies ie. Klauke®, Greenlee® and Alfra®.	1	1	49162685	045242337965

System accessories - Cable Cutter Blades suitable for M18™ HCCAC / M18™ HCCS

Description	Pack quantity	Min. order quantity	Article Number	EAN Code
① Cable cutter jaw and blade set for cutting aluminium-steel transmission cable. ACSS- Aluminium conductor steel supported cable and ACSR- Aluminium conductor steel reinforced cable i.e. 94-AL1 / 15-ST1A (EN 50182). Not suitable for armoured cable or steel rods.	1	1	49162773	045242350070
② Replacement cable cutter blades for ACSR-Jaw. Not suitable for armoured cable or steel rods.	1	1	48440412	045242355235
① Cable cutter jaw and blade set for cutting copper / aluminium. Copper / aluminium standard stranded cable up to 4 x 50 mm ² , 1 x 500 mm ² in Aluminium and 1 x 400mm ² in Copper. Not suitable for fine stranded/ highly flexible cable.	1	1	4932430839	4002395385010
② Replacement cable cutter blades for copper and aluminium.	1	1	4932430840	4002395385027



System accessories - Cable cutter blades for underground cutter M18 HCC75

NEW

Description	Pack quantity	Min. order quantity	Article Number	EAN Code
Underground cutter blade M18 HCC75.	1	1	49162774	045242486663



System accessories - Cable cutter blades for M18 HCC45

NEW

Description	Pack quantity	Min. order quantity	Article Number	EAN Code
ACSR blade M18 HCC45.	1	1	49162775	045242486632



Expander heads

Description	Pipe diameter (mm)	Pipe wall thickness (mm)	Pipe pressure (bar)	Suitable	Pack quantity	Min. order quantity	Article Number	EAN Code
PXPH9-144/8	9.9	1.1	4/8	M12, M18	1	1	4932430102	4002395377633
PXPH121-14	12	1.7/ 1.8/ 2	6-10	M12, M18	1	1	4932352716	4002395373741
PXPH15N-14	14 / 15	2.5	6-10	M12, M18	1	1	4932352727	4002395373857
PXPH161-1406	16	1.5/ 1.8	6	M12, M18	1	1	4932430103	4002395377640
PXPH161-1410	16	1.8/ 2.0/ 2.2	10	M12, M18	1	1	4932352717	4002395373758
PXPH18N-14	17 / 18	2.5	6-10	M12, M18	1	1	4932352728	4002395373864
PXPH201-1406	20	1.9/ 2.0/ 2.3	6, (8 bar - Ø 2.3 mm)	M12, M18	1	1	4932352718	4002395373765
PXPH201-1410	20	2.8	10	M12, M18	1	1	4932352719	4002395373772
PXPH201-2506	20	1.9/ 2.0/ 2.3	6, (8 bar - Ø 2.3 mm)	M18	1	1	4932352733	4002395373918
PXPH201-2510	20	2.8	10	M18	1	1	4932352748	4002395374069
PXPH22N-14	22	3	6-10	M12, M18	1	1	4932352729	4002395373871
PXPH251-1406	25	2.3	6	M12, M18	1	1	4932352720	4002395373789
PXPH251-1410	25	3.5	10	M12, M18	1	1	4932352721	4002395373796
PXPH251-2506	25	2.3	6	M18	1	1	4932352722	4002395373802
PXPH251-2510	25	3.5	10	M18	1	1	4932352749	4002395374076
PXPH28N-14	28	4	6-10	M12, M18	1	1	4932352730	4002395373888
PXPH321-1406	32	2.9	6	M12, M18	1	1	4932352723	4002395373819
PXPH321-25	32	2.9/ 4.4	6-10	M18	1	1	4932352724	4002395373826
PXPH401-2506	40	3.7	6	M18	1	1	4932352725	4002395373833
PXPH 401 - 5606	40	3.7	6-10	M18 BLPXPL	1	1	4932451396	4002395160884
PXPH 501 - 5606	50	4.6	6-10	M18 BLPXPL	1	1	4932451397	4002395160891
PXPH 631 - 5606	63	5.8	6-10	M18 BLPXPL	1	1	4932451398	4002395158102
PXPH 751 - 5606	75	6.8	6-10	M18 BLPXPL	1	1	4932451399	4002395158119
Grease					1	1	4932352726	4002395373840
Tube contents 50 g. For lubrication of cone and expander heads.								



System accessories - Routers

Description	Fits routers	Pack quantity	Min. order quantity	Article Number	EAN Code
Precision collet for router. High rotation accuracy.					
Ø 3 mm collet.	OFE 710, OFE 630 OFS 450	1	1	4932308974	4002395309092
Ø 6.35 mm (1/4") collet.	OFE 710, OFE 630 OFS 450	1	1	4932313194	4002395302857
Ø 6 mm collet.	OFE 710, OFE 630 OFS 450	1	1	4932313192	4002395302833
Ø 8 mm collet.	OFE 710, OFE 630 OFS 450	1	1	4932313190	4002395302840

①



System attachments - Biscuit jointers

Description	Fits biscuit jointers		Pack quantity	Min. order quantity	Article Number	EAN Code
Cutter	LF 650	PJ 710	1	1	4932361072	4002395326679
Frame holder for dust bag 4931443872	LF 650	PJ 710	1	1	4931442872	4002395247899
Spare paper bags for 4932345544.	LF 650	PJ 710	5	1	4931442873	4002395247882
Two hole spanner.	LF 650	PJ 710	1	1	4932345712	4002395305551



System accessories - Straight die grinders

Description	Fits die grinders	Pack quantity	Min. order quantity	Article Number	EAN Code
Ø 3 mm collet.	DGL 34,DGL 30 E,DG 30 E, PSG 12,PSG 14.4 PP,HD18 SG	1	1	4932308974	4002395309092
Ø 6 mm collet.	PSG 14.4 PP,HD18 SG, PSG 12,DG 30 E,DGL 30 E, DGL 34	1	1	4932313192	4002395302833
Ø 6 mm collet.	DG 7 E	1	1	4931391453	4002395734818
Ø 8 mm collet.	DGL 34,DGL 30 E,DG 30 E, PSG 12,PSG 14.4 PP,HD18 SG, V 28 SG	1	1	4932313190	4002395302840
Ø 8 mm collet.	DG 7 E	1	1	4931391452	4002395734801
Ø 6.35 mm (1/4") collet.	DGL 34,DGL 30 E,DG 30 E, PSG 12, PSG 14.4 PP,HD18 SG	1	1	4932313194	4002395302857



System attachments - Plate shears

Description	Fits plate shears	Pack quantity	Min. order quantity	Article Number	EAN Code
Piston four sided blade.	PPS 12	1	1	4932308837	4002395311583
Cutting table blade four sided blade.	KS 2.5,S 2.5	1	1	4932430171	4002395378326
	PPS 12	1	1	4932308838	4002395309085
Centre blade.	SMC 1.2 Q	1	1	48440150	045242140701
Left blade.	SMC 1.2 Q	1	1	48440160	045242140756
Right blade.	SMC 1.2 Q	1	1	48440170	045242140800
Socket wrench 5/32"	SMC 1.2 Q	1	1	49960070	045242221554



System accessories - Nibblers

Description	Fits nibblers	Pack quantity	Min. order quantity	Article Number	EAN Code
Punch.	KN 2 PN 14.4, PN 12,N 2	1	1	4932430172	4002395378333
Die.	KN 2 PN 14.4, PN 12,N 2	1	1	4932279565	4002395308521
Special die. Especially designed for cutting corrugated steel. Max. cutting capacity 1.5 mm.	KN 2 PN 14.4, PN 12,N 2	1	1	4932279498	4002395308514



System accessories - Pipe cutter / Cable cutter

Description	Pack quantity	Min. order quantity	Article Number	EAN Code
① Pipe cutter wheels. Suitable for copper pipe. Not suitable for plastic or stainless steel pipe.	2	1	48380010	045242159710
② Cable cutter blade	1	1	4932430070	4002395377312
PEX cutter blade for C12 PPC	1	1	4931441978	4002395179268



System accessories - Electrical T&M

Description	Pack quantity	Min. order quantity	Article Number	EAN Code
① Electrical test probes (max. 1000 Volts/ 10 Amps) heads 125 mm long.	1	1	49771004	045242238965
② Electrical alligator clips (max. 1000 Volts/ 10 Amps).	1	1	49771005	045242238972



Nails and Staples

Type	Wire gauge	Dimensions (mm)	Total length (mm)	Nail angle	Material	Pack quantity	Min. order quantity	Article Number	EAN Code	
① Brad nails	18	1,0 x 1,25	16	0°	Resin Coated. Galvanised	10,000	1	4932459124	4002395287796	
	18	1,0 x 1,25	19	0°	Resin Coated. Galvanised	10,000	1	4932459125	4002395288403	
	18	1,0 x 1,25	25	0°	Resin Coated. Galvanised	5,000	1	4932459126	4002395288410	
	18	1,0 x 1,25	30	0°	Resin Coated. Galvanised	5,000	1	4932459127	4002395288427	
	18	1,0 x 1,25	32	0°	Resin Coated. Galvanised	5,000	1	4932459128	4002395288434	
	18	1,0 x 1,25	40	0°	Resin Coated. Galvanised	5,000	1	4932459129	4002395288441	
	18	1,0 x 1,25	45	0°	Resin Coated. Galvanised	4,000	1	4932459130	4002395288458	
	18	1,0 x 1,25	50	0°	Resin Coated. Galvanised	4,000	1	4932459131	4002395288465	
	18	1,0 x 1,25	16	0°	Stainless / Rust free	10,000	1	4932459132	4002395288472	
	18	1,0 x 1,25	19	0°	Stainless / Rust free	10,000	1	4932459133	4002395288489	
	18	1,0 x 1,25	25	0°	Stainless / Rust free	5,000	1	4932459134	4002395288496	
	18	1,0 x 1,25	30	0°	Stainless / Rust free	5,000	1	4932459135	4002395289103	
	18	1,0 x 1,25	32	0°	Stainless / Rust free	5,000	1	4932459136	4002395289110	
	18	1,0 x 1,25	40	0°	Stainless / Rust free	5,000	1	4932459137	4002395289127	
	18	1,0 x 1,25	45	0°	Stainless / Rust free	4,000	1	4932459138	4002395289134	
	18	1,0 x 1,25	50	0°	Stainless / Rust free	4,000	1	4932459139	4002395289141	
	② Brad nails	16	1.36 x 1.65	32	20°	Galvanised	2,000	1	4932459140	4002395289158
		16	1.36 x 1.65	38	20°	Galvanised	2,000	1	4932459141	4002395289165
16		1.36 x 1.65	45	20°	Galvanised	2,000	1	4932459142	4002395289172	
16		1.36 x 1.65	50	20°	Galvanised	2,000	1	4932459143	4002395289189	
16		1.36 x 1.65	64	20°	Galvanised	2,000	1	4932459144	4002395289196	
③ Staples	Type 50	0,5 x 1,27	6		Galvanised	1,200	1	4932459145	4002395289806	
	Type 50	0,5 x 1,27	8		Galvanised	1,200	1	4932459146	4002395289813	
	Type 50	0,5 x 1,27	14		Galvanised	600	1	4932459147	4002395289820	



System accessories - Inspection cameras

All extension cables are water splash and dust proof.

Extensions are attached between the base camera unit and standard supplied camera cable.

Description	Cable length (m)	Cable diameter (mm)	Fits inspection cameras	Pack quantity	Min. order quantity	Article Number	EAN Code
Cable extension. Up to a maximum of 3 extensions can be fixed together.	0.9	17	C12 IC	1	1	48530110	045242157747
Cable extension. Up to a maximum of 5 extensions can be fixed together.	0.9	17	C12 AVD, C12 AVA	1	1	48530141	045242216529
Cable extension. Up to a maximum of 2 extensions can be fixed together.	2.4	17	C12 IC, C12 AVD, C12 AVA	1	1	48530140*	045242195787
Replacement digital camera cable.	0.9	17	C12 IC	1	1	4931411079	4002395907007
Replacement digital camera cable.	0.9	17	C12 AVD, C12 AVA	1	1	4931419516	4002395828227
Replacement analog camera cable.	0.9	9.5	C12 AVD, C12 AVA	1	1	4931419517	4002395828234
1m Replacement Cable Camera for the M-spector camera	1	12	M12 IC AV3	1	1	48530150	045242344208
3m Replacement Cable Camera for the M-spector camera	3	12	M12 IC AV3	1	1	48530151	045242344222
1 m articulating cable.	1	12	M12 IC AV3	1	1	48530155	045242344215

①



②



System attachments - M12™ heated jackets

- M18™ USB Power Source - M18™ USB PS HJ. Powers the jacket on M18™ battery packs. USB charging port for MP3 player, mobile phone, digital camera, GPS.
- 12 V Car Plug - 12 V CP HJ. Powers the jacket on any 12 V cigarette style outlet.

Description	Pack quantity	Min. order quantity	Article Number	EAN Code
① M18™ USB controller (M18™ USB PS HJ).	1	1	4932430084	4002395377459
② M12™ car plug (12 V CP HJ).	1	1	4932430085	4002395377466

①



②



* while stocks last

Side handles

Description	Pack quantity	Min. order quantity	Article Number	EAN Code
① Side handle with depth gauge for all drills and percussion drills with gear neck diameter 43 mm.	1	1	4932373725	4002395352647
② Side handle with depth gauge for all drills and percussion drills with a short gear neck (13 mm) of diameter 43 mm.	1	1	4932364149	4002395342198



QUIK-LOK cables

Cable length (m)	Country version	Pack quantity	Min. order quantity	Article Number	EAN Code
4	EU	1	1	4932373502	4002395351725
10	EU	1	1	4932373503	4002395351732
4	CH	1	1	4932373504	4002395351749
4	GB	1	1	4932373508	4002395351787
4	GB	1	1	4932373510	4002395351800
6	EU	1	1	4932364483 ¹	4002395337620
QUIK-LOK cable repair kit.		1	1	4931380758	4002395714551



¹ Heavy duty and acid resistant, non repairable

Universal right angle drill attachment

- Converts Milwaukee® HDE 13 RQD straight drill to angle drill.
- Used extensively for drilling between joists or in tight corners.
- Head and handle swivel 360°.
- Provides two speeds: 1. Low: speed decreases by 30% torque increases by 50%
2. High: speed increases by 50%

Description	Pack quantity	Min. order quantity	Article Number	EAN Code
Right angle drill attachment.	1	1	48062871	045242088812

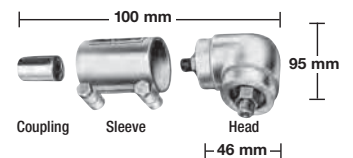

Head and handle swivel 360° and can be locked tight in any position.

System accessories - Line trimmer

NEW

Description	Pack quantity	Min. order quantity	Article Number	EAN Code
① Trimmer replacement head complete (includes spool and line 49162712)	1	6	49162710*	045242493937
② Trimmer replacement spool (includes 49162712 line)	1	6	49162711*	045242493920
③ 2 mm x 45 m trimmer line.	1	12	49162712	045242493906
③ 2.4 mm x 76 m trimmer line.	1	10	49162713	045242493913
Auto feed trimmer replacement spool (includes 49162712 line)	1	1	49162714	045242006458



* while stocks last

M12™ drain cleaner accessories

NEW

Description	Pack quantity	Min. order quantity	Article Number	EAN Code
① Ø 8 mm x 7.6 m spiral, bulb auger.	1	1	48532571	045242364213
② Ø 8 mm x 7.6 m spiral, pivot bulb auger.	1	1	48532572	045242364206
① Ø 6 mm x 7.6 m spiral, bulb auger.	1	1	48532573	045242471270
② Ø 6 mm x 7.6 m spiral, pivot bulb auger.	1	1	48532574	045242471287
③ Ø 8 mm x 7.6 m spiral, bulb auger with drum.	1	1	48532581	045242480586
④ Ø 8 mm x 7.6 m spiral, pivot bulb auger with drum.	1	1	48532582	045242480593
③ Ø 6 mm x 7.6 m spiral, bulb auger with drum.	1	1	48532583	045242480609
④ Ø 6 mm x 7.6 m spiral, pivot bulb auger with drum.	1	1	48532584	045242480616



M18™ FS drain cleaner accessories

NEW

Description	Pack quantity	Min. order quantity	Article Number	EAN Code
① Drain cleaner drum only.	1	1	4932464277	4058546222222
② 8 mm x 23 m spiral bulb auger M18™.	1	1	48532772	045242513079
② 10 mm x 15 m spiral M18™.	1	1	48532773	045242513086
② 13 mm x 15 m spiral M18™.	1	1	48532774	045242513093
② 16 mm x 15 m spiral M18™.	1	1	48532775	045242513109
③ Funnel retriever M18™.	1	1	48532786	045242006106
④ Drop head M18™.	1	1	48532787	045242006113
⑤ 38 mm spade bit M18FS.	1	1	48532788	045242006120
⑥ 38 mm grease cutter M18FS.	1	1	48532789	045242006137
⑦ M18FS 5 pcs attachment set.	5	1	48532790	045242006144



M18™ power speed drain cleaner accessories

NEW

Description	Pack quantity	Min. order quantity	Article Number	EAN Code
① 6 mm x 10.5 m spiral bulb auger M18PF.	1	1	48532671	045242482740
① 6 mm x 15 m spiral bulb auger M18PF.	1	1	48532672	045242482757
① 8 mm x 10.5 m spiral M18PF.	1	1	48532673	045242482764
① 8 mm x 15 m spiral bulb auger M18PF.	1	1	48532674	045242482771
① 10 mm x 10.5 m spiral M18PF.	1	1	48532675	045242482788
② Retriever bulb M18PF.	1	1	48532681	045242503803
③ Down retriever bulb M18PF.	1	1	48532682	045242503810
④ 25 mm spade bit M18PF.	1	1	48532683	045242503827
⑤ 25 mm grease cutter M18PF.	1	1	48532684	045242503834
⑥ M18PF 5 pcs attachment set.	5	1	48532685	045242503841



System accessories - Caulk and adhesive guns

Description	Fits caulk guns	Pack quantity	Min. order quantity	Article Number	EAN Code
310 ml standard carriage. Accepts all standard 250 ml and 310 ml tubes/cartridges. Requires plunger rod 49520600.	PCG 14 / 300, PCG 14 / 600	1	1	48081075	045242087938
310 ml standard carriage. Accepts all standard 250 ml and 310 ml tubes/cartridges. Includes plunger rod assembly (4932352937), piston for carriage assemblies and a feed screw (44700330).	C18 PCG	1	1	48081076	045242263127
310 ml standard carriage. Accepts all standard 250 ml and 310 ml tubes/cartridges. Includes plunger rod assembly (4932430099), piston for carriage assemblies and a feed screw (44700330).	C12 PCG	1	1	48080900	045242286355
310 ml aluminium sausage tube barrel. Accepts standard 310 ml "sausage style" material packs and 380 ml cartridges. Requires plunger rod 49520660.	PCG 14 / 300, PCG 14 / 600	1	1	48081085	045242089246
400 ml aluminium sausage tube barrel. Accepts standard 400 ml "sausage style" material packs (includes 2 end cups). Requires plunger rod (48091090) and piston (44700375).	C18 PCG,C12 PCG	1	1	4932352844	4002395375028
600 ml aluminium sausage tube barrel. Accepts standard 600 ml "sausage style" material packs. Requires plunger rod 49520660.	PCG 14 / 600, PCG 14 / 300	1	1	48081090	045242087952
600 ml aluminium sausage tube barrel. Accepts standard 600 ml "sausage style" material packs (includes 2 end cups). Requires plunger rod (48091091) and piston (44700375).	C18 PCG,C12 PCG	1	1	4932352845	4002395375035
400 ml transparent sausage tube barrel. Accepts standard 400 ml "sausage style" material packs (includes 2 end cups). Requires plunger rod (48091090) and piston (44700375).	C18 PCG,C12 PCG	1	1	4932352842	4002395375004
600 ml transparent sausage tube barrel. Accepts standard 600 ml "sausage style" material packs (includes 2 end cups). Requires plunger rod (48091091) and piston (44700375).	C18 PCG,C12 PCG	1	1	4932352843	4002395375011
Plunger rod assembly for 310 ml cartridges. For use with: 48081076 310 ml standard carriage.	C18 PCG	1	1	4932352937	4002395375950
Plunger rod assembly for 310 ml carriage. For use with: 48080900 310 ml standard carriage.	C12 PCG	1	1	4932430099	4002395377602
Plunger rod short (340 mm long). For use with: 48081075 carriage and 48081085 „sausage style“ barrel.	PCG 14 / 300, PCG 14 / 600	1	1	49520600	045242190201
Plunger rod assembly for 400 ml sausage tube barrel. For use with: 4932352844 400 ml aluminium sausage tube barrel. 4932352842 400 ml transparent sausage tube barrel.	C18 PCG	1	1	48091090	045242263158
Plunger rod assembly for 400 ml sausage tube barrel. For use with: 4932352844 400 ml aluminium sausage tube barrel. 4932352842 400 ml transparent sausage tube barrel.	C12 PCG	1	1	4932430100	4002395377619
Plunger rod assembly long (480 mm long). For use with 48081090.	PCG 14 / 300, PCG 14 / 600	1	1	49520660	045242190164
Plunger rod assembly for 600 ml sausage tube barrel. For use with: 4932352845 600 ml aluminium sausage tube barrel. 4932352843 600 ml transparent sausage tube barrel.	C18 PCG	1	1	48091091	045242263165
Plunger rod assembly for 600 ml sausage tube barrel. For use with: 4932352845 600 ml aluminium sausage tube barrel. 4932352843 600 ml transparent sausage tube barrel.	C12 PCG	1	1	4932430101	4002395377626
Piston for carriage assemblies.	C18 PCG,C12 PCG	1	1	44700330	045242260928
Piston for sausage tube barrels.	C18 PCG,C12 PCG	1	1	44700375	045242277438
Replacement nozzle.	PCG 14 / 300, PCG 14 / 600, C18 PCG,C12 PCG	1	1	45760525	4002395775323

System accessories for dust absorption systems

Description	Fits Milwaukee dust absorption systems	Pack quantity	Min. order quantity	Article Number	EAN Code
Extraction hose, anti static. 4 m long 36 mm diameter with tool adaptor.	AS 300 ELCP,AS 500 ELCP, AS 300 EMAC	1	1	4932352311	4002395369706
Extraction hose. 3.5 m long 32 mm diameter with tool adaptor.	AS 250 ECP	1	1	4932352312	4002395369713
Adaptor for direct connection of suction hose 330552.	AS 1,AS 2 C	1	1	4932326528	4002395310937
Universal adaptor Ø 35 / 33 / 27 mm.	WDC 1400 A,AS 1,AS 2 C, AS 3 W,ASE 1400,ASM 1400	1	1	4932369282	4002395338412
System Ø 35 mm Ø 35 mm suction tube 50 cm plastic.	ASE 1400,AS 1,AS 2 C, ASM 1400	1	1	4932346620	4002395319503
Ø 35 mm gap nozzle.	WDC 1400 A,ASE 1400,AS 1, AS 2 C,AS 3 W,ASM 1400	1	1	4932276048	4002395303250
Extension hose Ø 35 mm / 4 m long. Requires adaptor (362778).	WDC 1400 A,ASE 1400,AS 1, AS 2 C,AS 3 W,ASM 1400	1	1	4932330552*	4002395312719
Extraction hose Ø 35 mm / 5 m.	ASE 1400,ASM 1400	1	1	4932373626	4002395351534
System Ø 50 mm Extraction hose Ø 50 mm / 3 m.	NT 1200,NT 1500 A,NT 900	1	1	4932300171	4002395308576
Ø 50 mm wide gap nozzle.	ASE 1400,AS 1,AS 2 C, ASM 1400	1	1	4932316070	4002395310449
Ø 50 mm suction tube.	ASE 1400,AS 1,AS 2 C, ASM 1400	1	1	4932316069	4002395310432
Ø 50 mm to Ø 35 mm reduction sleeve.	ASE 1400,AS 1,AS 2 C, ASM 1400	1	1	4932316074	4002395310456
5 x 25 l fleece filter bags.	AS 250 ECP	5	1	4932352306	4002395369652
5 x 30 l fleece filter bags.	AS 300 ELCP,AS 300 EMAC, AS 300 ELAC	5	1	4932352307	4002395369669
5 x 50 l fleece filter bags.	AS 500 ELCP	5	1	4932352308	4002395369676
Filter bags: 5 x plastic bags, 30 l.	AS 250 ECP,AS 300 ELCP, AS 300 EMAC	5	1	4932352309	4002395369683
Filter bags: 5 x plastic bags, 50 l.	AS 500 ELCP	5	1	4932352310	4002395369690
Filter bag for RSE +AS2C, light duty	AS 1,AS 2 C,AS 3 W	1	1	4932346812	4002395319534
Filter bags. Heavy duty. 3 x 18 l paper bags.	NT 1500 A	1	1	4932373669	4002395351824
Filter bags. Heavy duty. 5 x 25 l paper bags.	AS 2 C,AS 3 W	5	1	4932346585	4002395319442
Filter bags. Heavy duty. 5 x 25 l paper bags.	RSE 1400	5	1	4932373852	4002395352821
Filter bags. Heavy duty. 5 x 50 l paper bags.	ASE 1400,ASM 1400	5	1	4932373621	4002395351503
Filter bags: cloth.	NT 900	1	1	4932276019	4002395303267
Filter bags. Suitable for fine concrete dust. Conforms to dust classification M & H EN 60335-2-69. Only suitable for ASM1400. 3 x 25 l plastic bags.	ASE 1400,ASM 1400	3	1	4932399502	4002395361595
Fleece filter bags for AS 30/42.	AS 30 LAC,AS 30 MAC, AS 42 MAC	5	1	4932459689	4058546028619
Disposable bags 30 l	AS 42 MAC,AS 30 MAC, AS 30 LAC	5	1	4932459690	4058546028626
Filter cartridge.	AS 250 ECP,AP 250 ECP	1	1	4932352303	4002395369621
Filter cartridge.	AS 300 ELCP,AS 500 ELCP, AS 2-250 ELCP	1	1	4932352304	4002395369638
Filter cartridge.	AS 300 EMAC,AS 300 ELAC	1	1	4932352305	4002395369645
Filter cartridge, 3600 cm², BIA usage Cat. C.	AS 1	1	1	4932346587	4002395319466
Filter cartridge, 7000 cm², BIA usage Cat. C.	AS 3 W	1	1	4932346588	4002395319473
Filters Filter cartridge, 7200 cm².	RSE	1	1	4932327205	4002395303885
Filter cartridge.	NT 1200,NT 1500 A	1	1	4932340124	4002395305452
Flat folded polyester filter cartridge, 2 pcs.	ASE 1400,ASM 1400	1	1	4932373623	4002395351510
PTFE flat filter.	AS 30 LAC,AS 42 MAC, AS 30 MAC	1	1	4932459687	4058546028596
Motor cooling filter.	AS 42 MAC,AS 30 MAC, AS 30 LAC	1	1	4932459688	4058546028602
Metal push handle.	AS 42 MAC,AS 30 MAC, AS 30 LAC	1	1	4932459691	4058546028633

¹ In combination with 4932346812 bag adapter and filter cartridge 4932346587.

* while stocks last

M12 / M18 Dust extraction system attachments

Description	Fits Milwaukee dust absorption systems	Pack quantity	Min. order quantity	Article Number	EAN Code
① Drilling nozzle.	M18 CDEX / M18/28 CPDEX, M12 DE	2	1	49902301	045242337279
② Filter.	M18 CDEX / M18/28 CPDEX, M12 DE	3	1	49902306	045242299454
③ Crevice nozzle.	M12 DE	1	1	49902325*	045242297603
④ 3 pc set. Filter box, filter, box lid.	M12 DE	3	1	49902340	045242299461
⑤ M18 & M28 Dustbox with filter box, filter	M18 CDEX / M18/28 CPDEX	4	1	49902342	045242341948
⑥ Dust thru-box to allow connection of the M12 DE to an independent dust extraction / vacuum cleaner. Outlet nozzle: Ø 37 mm outside / Ø 32 mm inside.		1	1	4932430479	4002395381401



Dust extraction

Description	Pack quantity	Min. order quantity	Article Number	EAN Code
① Dust collection ring for collecting dust when overhead drilling. Suitable for Ø 5 - 8 mm.	1	1	4932430912	4002395385744
Dust bag, cloth. For use with Clean Line dust system 345547.	1	1	4932346182	4002395313273
② Extractor for dust collection on the wall or when overhead drilling. Maximum diameter drill bit Ø 28 mm. Fits to all industrial dust extraction units (universal reception Ø 26 - 41 mm).	1	1	4932430446	4002395381074
③ Drilling shroud - PHDE72. For drilling and coring from Ø 6 - 72 mm. Brush insert to improve suction and extraction. Brushes to be removed for coring applications. Outlet nozzle: Ø 37 mm outside / Ø 32 mm inside. Replacement sealing lips (2 pcs): 4931448564. Replacement brush: 4931448565	1	1	4932430480	4002395381418
DE16 - Vac assist universal extractor				
④ DE16 unit, 1 x side handle and 3 x neck collars-allows fitting to drills with gear neck from Ø 43 - 59 mm. 2 x drilling nozzles (49902301).	1	1	4932430835	4002395384976



* while stocks last

Chargers



Description	System	Charging range	Charging time	For battery type NiCd	For battery type NiMH	For battery type Li-Ion	Article Number	EAN Code
① M4 C	M4	4 V	30 min	-	-	Yes	4932352958	4002395376162
② L4 C	REDLITHIUM™ USB	4 V	120 min	No	No	Yes	4932459446	4058546011079
③ C12 C	M12	12 V	40/70/80/130 min	-	-	Yes	4932352000	4002395366606
④ M12 TC	M12	12 V	2.5/4/5/8 hrs.	No	No	Yes	4932459450	4058546011116
⑤ M12 C4	M12	12 V	40/70/80/130 min	-	-	Yes	4932430554	4002395382156
⑥ M12-18C	M12,M14,M18	12 - 18 V	40/80/100/124/180 min	-	-	Yes	4932352959	4002395376179
⑦ M12-18 AC	M12,M14,M18	12 - 18 V	40/80/100/124/180 min	-	-	Yes	4932459205	4002395287208
⑧ M12-18 FC	M12,M14,M18	12 - 18 V	26/47/59/68/95 min	-	-	Yes	4932451079	4002395810581
⑨ M1418 C6	M14,M18	14.4 V - 18 V	40/80/100/124/180 min	-	-	Yes	4932430086	4002395377473
⑩ M28 C	M28	28 V	60/90 min	-	-	Yes	4932352524	4002395371822

Lamps & bulbs

M12™ Lamps



Description	Voltage (V)	Battery type	System	Battery compatibility	Bulb type	Article Number	EAN Code
① M12 TLED-0	12	Li-ion	M12	All Milwaukee® M12™ batteries	LED	4932430360	4002395380213
② M12 SL-0	12	Li-ion	M12	All Milwaukee® M12™ batteries	LED	4932430178	4002395378395
③ M12 LL-0	12	Li-ion	M12	All Milwaukee® M12™ batteries	LED	4932430562	4002395382231
④ M12 SLED-0	12	Li-ion	M12	All Milwaukee® M12™ batteries	LED	4933451261	4002395170159
⑤ M12 UHL-0	12	Li-ion	M12	All Milwaukee® M12™ batteries	LED	4933459432	4058546010935
⑥ M12 MLED-0	12	Li-ion	M12	All Milwaukee® M12™ batteries	LED	4933451899	4002395281480
⑦ M12 AL-0	12	Li-ion	M12	All Milwaukee® M12™ batteries	LED	4933451394	4002395158621

M18™ Lamps



Description	Voltage (AC) (V)	Voltage (DC) (V)	Battery type	System	Battery compatibility	Bulb type	Article Number	EAN Code
① M18 TLED-0	–	18	Li-ion	M18	All Milwaukee® M18™ batteries	LED	4932430361	4002395380220
② M18 IL-0	–	18	Li-ion	M18	All Milwaukee® M18™ batteries	LED	4932430564	4002395382255
③ M18 LL-0	–	18	Li-ion	M18	All Milwaukee® M18™ batteries	LED	4932430563	4002395382248
④ M18 SLED-0	–	18	Li-ion	M18	All Milwaukee® M18™ batteries	LED	4933459159	4002395287147
⑤ M18 AL-0	–	18	Li-ion	M18	All Milwaukee® M18™ batteries	LED	4932430392	4002395380534
⑥ M18 HAL-0	220 - 240	18	Li-ion	M18	All Milwaukee® M18™ batteries	LED	4933451262	4002395170166
⑦ M18 PAL-0	–	18	Li-ion	M18	All Milwaukee® M18™ batteries	LED	4933464105	4058546220501
⑧ M18 SAL-0 M18 SAL-502B	–	18	Li-ion	M18	All Milwaukee® M18™ batteries	LED	4933451246 4933451896	4002395167708 4002395281459
⑨ M18 HSAL-0 M18 HSAL-502B	220 - 240	18	Li-ion	M18	All Milwaukee® M18™ batteries	LED	4933451392 4933451898	4002395158607 4002395281473
⑩ M18 ONERSAL-0	–	18	Li-ion	M18	All Milwaukee® M18™ batteries	LED	4933459431	4058546010928
⑪ M18 SLSP-0	220 - 240	18	Li-ion	M18	All Milwaukee® M18™ batteries	LED	4933451514	4002395162222
⑫ M18 ONESLSP-0	220 - 240	18	Li-ion	M18	All Milwaukee® M18™ batteries	LED	4933459155	4002395287109
⑬ M18 ONESLDP-0	100 - 240	18	Li-ion	M18	All Milwaukee® M18™ batteries	LED	4933459160	4002395287154

Lamps expansion



Description	Voltage (AC) (V)	Voltage (DC) (V)	Battery type	System	Battery compatibility	Bulb type	Article Number	EAN Code
① M28 WL LED-0	–	28	Li-ion	M28	All Milwaukee® M28™ batteries	LED	4932352527	4002395371853
② L4 FL-201	–	4	Li-ion	REDLITHIUM™ USB	REDLITHIUM™ USB battery	LED	4933459442	4058546011031
③ L4 HL-201	–	4	Li-ion	REDLITHIUM™ USB	REDLITHIUM™ USB battery	LED	4933459443	4058546011048
④ L4 MLED-201	–	4	Li-ion	REDLITHIUM™ USB	REDLITHIUM™ USB battery	LED	4933459444	4058546011055
⑤ IPL-LED	–	3.0	Alkaline	Alkaline	AAA	LED	4933459440	4058546011017
⑥ HL-LED	–	4.5	Alkaline	Alkaline	AAA	LED	4933459441	4058546011024
⑦ HOBL 7000	90 - 277	–	–	Corded	–	LED	4933464126	4058546220716

Batteries

Description	System	Battery type	Voltage (V)	Battery pack capacity (Ah)	Article Number	EAN Code
① M4 B2	M4	Li-ion	4	2.0	4932430098	4002395377596
② L4 B2	REDLITHIUM™ USB	Li-ion	4	2.5	4932459445	4058546011062
③ M12 B2	M12	Li-ion	12	2.0	4932430064	4002395377251
④ M12 B3	M12	Li-ion	12	3.0	4932451388	4002395157969
⑤ M12 B4	M12	Li-ion	12	4.0	4932430065	4002395377268
⑥ M12 B6	M12	Li-ion	12	6.0	4932451395	4002395158638
⑦ M14 B	M14	Li-ion	14.4	1.5	4932352665	4002395373239
⑧ M14 B4	M14	Li-ion	14.4	4.0	4932430323	4002395379842
⑨ M18 B2	M18	Li-ion	18	2.0	4932430062	4002395377237
⑩ M18 B4	M18	Li-ion	18	4.0	4932430063	4002395377244
⑪ M18 B5	M18	Li-ion	18	5.0	4932430483	4002395381449
⑫ M18 B6	M18	Li-ion	18	6.0	4932451244	4002395167661
⑬ M18 B9	M18	Li-ion	18	9.0	4932451245	4002395167678
⑭ M28 BX	M28	Li-ion	28	3.0	4932352732	4002395373901
⑮ M28 B5	M28	Li-ion	28	5.0	4932430484	4002395381456



Milwaukee

Nothing but **HEAVY DUTY.**



Hand Tools

Premium magnetic tape measures



Finger stop

- Patented finger stop: stable when stands alone.
- Compact and ergonomic design.
- Improved, more compact hook for better side marking and scale visibility.
- Improved belt clip: more pocket friendly.
- Nylon non-reflective bond blade protection, up to 10x more resistant to jobsite damage.
- 27 mm blade with double sided printing on tape for easier readability.
- Strong magnet at start of the tape allows easy hooking onto flat surfaces and round pipe.
- Architect scale provides easy calculating of scaled drawings.
- 5-point reinforced frame for jobsite durability.
- Class II accuracy.



5-point reinforced frame

Description	Length (m)	Pack quantity	Min. order quantity	Article Number	EAN Code
5 m metric	5	1	6	48227305	045242486953
8 m metric	8	1	6	48227308	045242486960
10 m metric	10	1	6	48227310	045242486977
5 m / 16 ft metric & imperial	5 / 16'	1	6	48227216	045242486939
8 m / 26 ft metric & imperial	8 / 26'	1	6	48227225	045242486946
10 m / 33 ft metric & imperial	10 / 33'	1	6	48227233	045242521944



Strong magnet

Premium magnetic tape measures - bulk packs

Description	Length (m)	Pack quantity	Min. order quantity	Article Number	EAN Code
5 m metric bulk pack	5	1	12	4932459373	4058546010348
5 m / 16 ft metric & imperial bulk pack	5 / 16'	1	12	4932459374	4058546010355
8 m metric bulk pack	8	1	12	4932464177	4058546221225
8 m / 26 ft metric & imperial bulk pack	8 / 26'	1	12	4932464178	4058546221232



2-sided scale printing

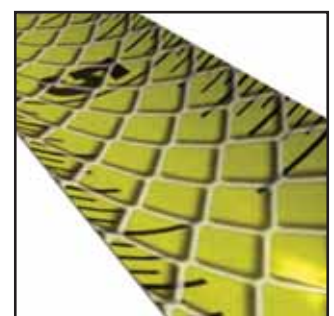

Nylon coating

Pro compact tape measures

NEW

- Improved ergonomics and comfortable size.
- Jobsite durability.
- 5 Point reinforced housing.
- 2G nylon coated blade protection.
- Improved tape tear and flexibility.
- Withstands 3 m drop test.
- Non magnetic.
- Heavier font on measurements for better readability.
- Smaller compact hook design.
- Back rest for easy vertical measuring.
- Improved belt clip: more pocket friendly.



Description	Length (m)	Blade width (mm)	Pack quantity	Min. order quantity	Article Number	EAN Code
Pro compact tape measure C3/16	3	16	1	12	4932459591	4058546027636
Pro compact tape measure C5/19	5	19	1	12	4932459592	4058546027643
Pro compact tape measure C5/25	5	25	1	6	4932459593	4058546027650
Pro compact tape measure C8/25	8	25	1	6	4932459594	4058546027667
Pro compact tape measure C5-16/25	5 / 16"	25	1	24	4932459595	4058546027674
Pro compact tape measure C8-26/25	8 / 26"	25	1	12	4932459596	4058546027681

Slimline tape measures

NEW

- Very compact and improved ergonomic design.
- Nylon coated blade protection against debris, dirt and water.
- ABS housing with softgrip rubber gripping area for extra comfort and jobsite durability.
- 4 point reinforced frame.
- Flat base for horizontal stability and back rest for easy vertical measuring.
- Belt clip.
- Class II accuracy.
- Orders are only possible in master cartons with 24, 12 or 6 tapes depending on sku.



Description	Length (m)	Blade width (mm)	Pack quantity	Min. order quantity	Article Number	EAN Code
S3 / 16	3	16	1	12	48227703	045242512898
S5 / 19	5	19	1	12	48227705	045242512904
S5 / 25	5	25	1	6	48227706	045242512911
S8 / 25	8	25	1	6	48227708	045242512928
S5-16 / 25	5/16'	25	1	24	48227717	045242512935
S8-26 / 25	8/26'	25	1	24	48227726	045242512942

Tape measure - 2 m / 6'

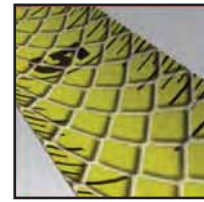

Nylon coating

- 5-point reinforced frame for job site durability.
- Heavy Duty blade with 13 mm blade width.
- Double sided nylon bond blade protection for extreme tape durability against dust, dirt, debris and water.
- Compact design and overmould gripping area for extra comfort and durability.
- Bulk packed, order in multiples of 12 pcs.

Description	Length (m)	Pack quantity	Min. order quantity	Article Number	EAN Code
2 m/6 ft metric & imperial	2	1	12	48225502	045242468034

Composite folding rule

- Locks at 90°/180°.
- Angle reference, rust free.
- Water resistant.
- Wear resistant markings.

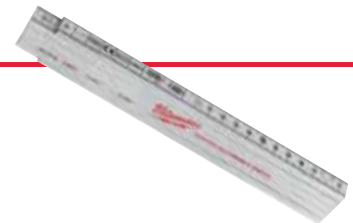

Description	Length (m)	Blade width (mm)	Accuracy	Links	Hinge	Pack quantity	Min. order quantity	Article Number	EAN Code
Composite folding rule	2	15 x 3.20	Class 2	10	Plastic and stainless steel	1	10	4932459301	4058546002671

Wood folding rule

- Locks at 90°/180°.
- Angle reference.



Description	Length (m)	Blade width (mm)	Accuracy	Links	Hinge	Pack quantity	Min. order quantity	Article Number	EAN Code
Wood folding rule	2	16 x 3.20	Class 3	10	Brass	1	12	4932459302	4058546002688

Slim wood folding rule

- Locks at 180°.
- Flexible slim design.



Description	Length (m)	Blade width (mm)	Accuracy	Links	Hinge	Pack quantity	Min. order quantity	Article Number	EAN Code
Slim wood folding rule	2	16 x 2.70	Class 3	10	Brass	1	10	4932459303	4058546002695

Long open tapes

- Steel blade design with nylon clad (extra thick nylon coating) for increased durability.
- Best in class stretch performance: up to 50% less stretch vs. fibreglass tapes.
- Ultra durable design: reinforced metal handle and drop durability.
- 3:1 clutched planetary gearing for 10x longer gear durability and smooth rewind.
- GRIME GUARD: debris wiper keeps blade clean and clear of abrasive material.
- Class II accuracy.
- 2 sided scale printing. Metric measurements shown on the top side and imperial (inches and feet) on the underside of the blade.



Description	Length (m)	Blade width (mm)	Pack quantity	Min. order quantity	Article Number	EAN Code
① Long open tape combi 30m/100ft	30	13	1	1	48225203	045242486069
② Long open tape combi 100m/330ft	100	9.5	1	1	48225211	045242486076

Long closed tapes

- Single sided 30 m metric tape with 9.5 mm blade width.
- GRIME GUARD: debris wiper keeps blade clean and clear of abrasive material.
- Ultra durable design: reinforced metal frame housing, reinforced handle and steel blade with nylon coating.
- 3:1 clutched planetary gearing for 10x longer gear durability and smooth rewind.
- Class II accuracy



Description	Length (m)	Blade width (mm)	Pack quantity	Min. order quantity	Article Number	EAN Code
Long closed tape 30m	30	9.5	1	1	48225103	045242486106

REDSTICK™ Backbone box levels



- All-metal BACKBONE™. Strongest, most durable frame. Reinforced vial retention.
- SHARPSITE™ vial technology. Best readability and impact protected.
- Wide, durable handles for comfort and portability.
- Precision milled measuring surface guarantees accuracy in all working positions.
- High contrast vial system is easy to clean and optimises visibility.
- High density, removable end caps protect frame and provide access in tight spaces.
- Overmolded, non-slip grips stick to the wall and prevent sliding and usable with end caps on or off.
- Durable, all-metal hang hole for storage.
- Guaranteed lifetime accuracy. Accurate to 0.029° (0.0005 ʹ/in, 0.5 mm/m) In normal and reverse position.
- Amplified rare earth magnets for maximum holding power (only magnetic levels)



Strongest, most durable frame, all metal reinforced BACKBONE™



SHARPSITE™ vial technology, best readability



Amplified rare earth magnets for maximum holding power (only magnetic levels)



30 YEARS ACCURACY GUARANTEE
JAHRE GENAUIGKEITSGARANTIE
ANS DE PRECISION GARANTIE
www.milwaukee.eu



Description	Length (cm)	Handles	Pack quantity	Min. order quantity	Article Number	EAN Code
40 cm magnetic	40	0	1	1	4932459061	4002395280322
60 cm magnetic	60	0	1	1	4932459063	4002395280346
80 cm magnetic	80	1	1	1	4932459065	4002395280360
100 cm magnetic	100	0	1	1	4932459067	4002395280384
120 cm magnetic	120	2	1	1	4932459069	4002395281008
180 cm magnetic	180	2	1	1	4932459071	4002395281046
200 cm magnetic	200	2	1	1	4932459073	4002395281060
240 cm magnetic	240	2	1	1	4932459075	4002395281084
40 cm non-magnetic	40	0	1	1	4932459060	4002395280315
60 cm non-magnetic	60	0	1	1	4932459062	4002395280339
80 cm non-magnetic	80	1	1	1	4932459064	4002395280353
100 cm non-magnetic	100	0	1	1	4932459066	4002395280377
120 cm non-magnetic	120	2	1	1	4932459068	4002395280391
180 cm non-magnetic	180	2	1	1	4932459070	4002395281015
200 cm non-magnetic	200	2	1	1	4932459072	4002395281053
240 cm non-magnetic	240	2	1	1	4932459074	4002395281077
End-caps for REDSTICK™ Backbone levels.			2	1	4932459680	4058546028527

REDSTICK[™] Compact box levels

NEW



- SHARPSITE[™] vial technology improves the readability of the vial.
- Compact and durable frame.
- Bottom milled measuring surface provides maximum accuracy.
- High contrast vial system is easy to clean and optimises visibility.
- Amplified rare earth magnets for maximum holding power (only magnetic levels).
- Accurate to 0.029° (0.0005 ʹ/in, 0.5 mm/m) in standard position.
- Shock absorbing rubber end caps.



Description	Length (cm)	Handles	Pack quantity	Min. order quantity	Article Number	EAN Code
40 cm magnetic	40	0	1	1	4932459079	4002395281725
60 cm magnetic	60	0	1	1	4932459081	4002395281749
80 cm magnetic	80	0	1	1	4932459083	4002395281763
100 cm magnetic	100	0	1	1	4932459085	4002395281787
120 cm magnetic	120	0	1	1	4932459087	4002395282401
180 cm magnetic	180	0	1	1	4932459089	4002395282425
40 cm non-magnetic	40	0	1	1	4932459078	4002395281718
60 cm non-magnetic	60	0	1	1	4932459080	4002395281732
80 cm non-magnetic	80	0	1	1	4932459082	4002395281756
100 cm non-magnetic	100	0	1	1	4932459084	4002395281770
120 cm non-magnetic	120	0	1	1	4932459086	4002395281794
180 cm non-magnetic	180	0	1	1	4932459088	4002395282418
End-caps for REDSTICK [™] Compact levels.			2	1	4932459681	4058546028534

Slim box levels



- 2 solid acrylic vials. Shockproof and UV resistant.
- Precision milled measuring surface up to 120 cm guarantees maximum accuracy
- Shock absorbing end caps.
- Non-slip grips stick to the wall and prevent sliding.
- Durable hang hole for storage.
- VPA third party certificate on accuracy.
- Guaranteed lifetime accuracy. Accurate to 0.029° (0.0005 ʹ/in, 0.5 mm/m)



Description	Length (cm)	Pack quantity	Min. order quantity	Article Number	EAN Code
Slim box level 40 cm	40	1	1	4932459090	4002395282432
Slim box level 60 cm	60	1	1	4932459091	4002395282449
Slim box level 80 cm	80	1	1	4932459092	4002395282456
Slim box level 100 cm	100	1	1	4932459093	4002395282463
Slim box level 120 cm	120	1	1	4932459094	4002395282470
Slim box level 180 cm	180	1	1	4932459095	4002395282487
Slim box level 200 cm	200	1	1	4932459590	4058546027629

REDSTICK™ concrete levels

NEW



- SHARPSITE™ vial technology improves the readability of the vial.
- Ergonomic keyhole profile delivers maximum durability and continuous grip across entire level.
- Wide magnesium base for enhanced screeding functionality and cleanability.
- Dedicated working edges include a rounded and a squared bottom edge for cutting and finishing concrete.
- High contrast vial system is easy to clean and optimises visibility.
- Vial surrounds are optimised for screeding applications and cleanability.
- Slope vials rated for 1/8" & 1/4" (1% & 2%).



Description	Length (cm)	Handles	Pack quantity	Min. order quantity	Article Number	EAN Code
60 cm non-magnetic	60	0	1	1	4932459893	4058546030650
120 cm non-magnetic	120	0	1	1	4932459894	4058546030667
180 cm non-magnetic	180	0	1	1	4932459895	4058546030674

REDCAST die-cast levels



- 2 solid acrylic vials. Shockproof and UV resistant.
- 2 Heavy Duty cast aluminium „anvil“ strike pads for trowel blows during tile work.
- Drill bit diameter gauge in the level's profile from 5 to 12 mm.
- Precision milled measuring surface guarantees accuracy in all working positions.
- Durable hang hole for storage.
- VPA third party certificate on accuracy.
- Guaranteed lifetime accuracy. Accurate to 0.029° (0.0005"/in, 0.5 mm/m)



Description	Length (cm)	Pack quantity	Min. order quantity	Article Number	EAN Code
REDCAST™ die-cast level 60 cm	60	1	1	4932459098	4002395283118
REDCAST™ die-cast level 80 cm	80	1	1	4932459099	4002395283125

Block torpedo level



- SHARPSITE™ vial technology. Best readability and impact protected.
- Locking 360° adjustable vial. Identify and repeat any angle needed on the jobsite. Lock vial in place to keep accuracy in and out of pocket/pouch.
- Amplified rare earth magnets. Amplified magnetic circuit design redirects field delivering 2X holding power.
- Reinforced plumb vials. Solid, acrylic block vials offer durability and maximum readability.
- Die cast aluminium body withstands the conditions of the jobsite.
- Precision milled measuring surface guarantees accuracy in all working positions.
- Lanyard hole for use with all most prevention programs.
- Accurate to 0.029° (0.0005 ʹ/in, 0.5 mm/m)



Description	Length (cm)	Pack quantity	Min. order quantity	Article Number	EAN Code
Block torpedo level	25	1	1	4932459096	4002395282494

Billet torpedo level



- Amplified rare earth magnets. Amplified magnetic circuit design redirects field delivering 2X holding power.
- Maximised viewing area. Easily read slope in 1/8" or 1/4" per foot in either direction.
- Reinforced acrylic vials offer durability and maximum readability.
- Weld clearance. Easily level over weld joints in pipes and other materials.
- Optimised V-groove design for stability on non-ferrous pipes.
- Laser etched ruled edge for quick measurements on material.
- Slim, tapered design for easy sliding in and out of pockets and pouches.



Description	Length (cm)	Pack quantity	Min. order quantity	Article Number	EAN Code
Billet torpedo level	17	1	1	4932459097	4002395283101

Pocket level

NEW

- 360° adjustable vial for reading angles.
- Locking mechanism for repetitive use in and out of pocket/pouch.
- Amplified Rare-Earth magnets for maximum holding power.
- V-groove for leveling on pipes.
- Milled edge to ensure accuracy.
- Compact size for jobsite functionality.



Description	Length (cm)	Pack quantity	Min. order quantity	Article Number	EAN Code
Pocket level	7.8	1	1	4932459597	4058546027698

Minibox level

- Lightweight aluminium box profile fits easily into your tool belt or pocket.
- Solid acrylic vial. Shockproof and UV resistant vials.
- Shockproof end caps.
- Guaranteed lifetime accuracy. Accurate to 0.029° (0.0005"/in, 0.5 mm/m)
- VPA third party certificate on accuracy.



Description	Length (cm)	Pack quantity	Min. order quantity	Article Number	EAN Code
Minibox level 10 cm	10	1	10	4932459100	4002395283446

INKZALL[™] markers

- Stays sharp, doesn't mushroom or push back under pressure.
- Acrylic nib ideal for rough surfaces such as OSB and concrete.
- Marker continues to write after 72+ hours of cap off time.
- For use on concrete, wood, metal, plywood, OSB, plastic.
- Can be used on wet, oily, dusty, rusty, with debris surfaces.
- Quick dry time – reduced smearing markings on PVC, metal surfaces.
- Thin body for use in restricted areas.
- Helmet clip – can be clipped to the construction site cap, trousers, overalls.
- Easy open cap for one hand operation.
- Lanyard Hole, e.g. to attach the pen to the tough screen device.
- Anti-Roll design – body design for better grip.

Description	Colour	Tip	Pack quantity	Min. order quantity	Article Number	EAN Code
① Fine point marker*	Black	1 mm	1	36	48223100	045242319473
② Fine point marker*	Red	1 mm	1	36	48223170	045242355259
③ Fine point marker with stylus	Black	1 mm	1	1	48223101	045242297436
④ Chisel point marker	Black	1- 4.8 mm	1	1	48223103	045242333608
⑤ Fine tip colour marker Blue, red, green and black		1 mm	4	1	48223106	045242333585

Fine tip* - Orders are only possible in master cartons (contains 36 x 48223100). Minum order quantity is 36 pcs (= 1 master carton). Order quantities greater than 36 pcs are to be ordered in multiples of 36 pcs (i.e. 72, 108, 144, 180...).



INKZALL[™] Liquid Paint Markers

- Valve action marker
- Durable acrylic nib for the most demanding environmental conditions: surface temperature from -10° up to + 145°
- Marks on dark surfaces where traditional markers would not be easily visible
- Can be used on rough, dirty and greasy surfaces
- For use on concrete, black pipe, aluminium, PVC, steel & stainless steel, rubber and tyres
- 10 seconds dry time
- Water and UV resistant markings
- Permanent markers. Markings last up to 6 months
- Metal barrel for construction site durability
- Xylene-free paint
- **IMPORTANT:** Shake the marker with the cap on. Remove the cap and carefully pump it up and down until ink flows into the nib



Description	Pack quantity	Min. order quantity	Article Number	EAN Code
① INKZALL [™] White Liquid Paint Marker	1	12	48223711	045242363360
② INKZALL [™] Yellow Liquid Paint Marker	1	12	48223721	045242363377
③ INKZALL [™] Black Liquid Paint Marker	1	12	48223731	045242363384



NEW

INKZALL™ highlighters

- Durable tip stays sharp longer.
- No smearing, doesn't bleed through.
- Non-toxic ink, ASTM D 4236 certification.
- Ideal for architectural drawings, labels, office paper.
- Anti-roll body design for better grip on smooth surfaces.
- Construction helmet clip: the INKZALL™ highlighters can be clipped to the helmet, trousers, overalls, etc.
- Lanyard hole, e.g. to attach the INKZALL™ highlighters to the belt.

Description	Pack quantity	Min. order quantity	Article Number	EAN Code
① INKZALL™ highlighter - yellow	5	1	48223201	045242482573
② INKZALL™ highlighter - coloured	5	1	48223206	045242482580



INKZALL™ Fine tip markers

NEW

- Approx. 0.6 mm tip.
- Clog resistant.
- Main applications: marking of labels for electrical wires, adding comments to architect plans.

Description	Colour	Pack quantity	Min. order quantity	Article Number	EAN Code
① INKZALL™ fine tip marker.	Black	4	1	48223154	045242479764
② INKZALL™ Fine tip black pen.	Black	4	1	48223164	045242479818
③ INKZALL™ Fine tip colour pen.	Black, red and blue	4	1	48223165	045242479825



FASTBACK[™] flip utility knife

- One handed blade opening. User can flip open the blade with one hand for easy activation.
- Integrated gut hook. Allows users to make cuts without exposing the blade.
- Tool free blade change. Less down time in the field for blade changes.
- Wire stripper. Eliminates the need to look for another tool in user's bag.
- Thin body design. Tool is easily stored in user's pocket.
- Belt clip for easy storage.



Description	Pack quantity	Min. order quantity	Article Number	EAN Code
① FASTBACK [™] knife	1	6	48229901	045242367047
② FASTBACK [™] flip utility knife with blade storage	1	1	48221903	045242292547
③ FASTBACK [™] compact flip utility knife	1	1	48221906	045242359196

Fastback folding knife

- Press and flip operation permits one-handed opening.
- Resharpenable stainless steel blade.
- Piercing tip allows controlled piercing and smooth cutting.
- Liner lock secures the blade in the open position.
- Lanyard hole.
- Wire form belt clip for quick access without fraying pockets.
- Compact size for carrying in the pocket.



Description	Pack quantity	Min. order quantity	Article Number	EAN Code
FASTBACK [™] folding knife	1	1	48221990	045242296842

Hardline folding knives

- Premium D2 blade steel provides better corrosion resistance. High strength and wear resistance, stays sharp longer.
- Smooth / serrated 75mm blade and piercing tip. Ideal for tearing through material and tip allows controlled piercing.
- Flip opening with bearing system: can be opened with 2 hands only.
- Opening steel frame lock secures the blade in the open position.
- Glass filled nylon handle with stainless steel.
- Liner lock secures the blade in the open position.
- Lanyard hole.
- Reversible belt clip allows right or left handed carry.



Description	Blade type	Pack quantity	Min. order quantity	Article Number	EAN Code
① Hardline [™] folding knife smooth	Smooth	1	1	48221994	045242477043
② Hardline [™] folding knife serrated	Serrated	1	1	48221998	045242359165

Sliding utility knife

- Side blade activation: Reduces the risk of exposing the blade accidentally.
- Wire stripper: Eliminates the need for another tool in the users bag.
- Tool free blade change: Saves time changing blades.
- Blade storage: Magnetic holder for 5 blades.
- Heavy Duty: Full metal body with rubber overmould for increased comfort and reduced hand slippage.



6 pcs master carton

Description	Pack quantity	Min. order quantity	Article Number	EAN Code
① Sliding utility knife	1	6	48229910	045242367054

Self-retracting safety knife

- Self-retract mechanism: Retracts blade when the button is released.
- Two blade positions allows user to control cutting depth.
- Blade storage holds up to 5 blades conveniently inside the handle.
- Tool-free blade change: Saves time changing blades. Thumb-screw mechanism allows to change the blade quickly and without any extra tools.
- Heavy Duty: Durable full metal body.
- Wire Stripper: Eliminates the need to look for another tool in users's bag. Cut up the wire up to Ø 5 mm².



Description	Pack quantity	Min. order quantity	Article Number	EAN Code
Self-retracting safety knife	1	1	48221915	045242296873

General purpose utility blades

- Iron carbide deposited metal for longer lifetime.
- Optimised cutting angle geometry for sharpness.
- Extra ground cutting edge for cleaner cuts.
- Blades are protected and easily accessible from storage box.

Description	Total length (mm)	Height (mm)	Pack quantity	Min. order quantity	Article Number	EAN Code
① General purpose utility knife blades	62	19	50	1	48221950	045242344444
			5	1	48221905	045242268061
② Hook utility knife blades	62	19	50	1	48221952	045242286980
③ Carton utility knife blades (rounded).	62	19	5	1	48221934	045242286942



Snap knives

- Metal lock* for maximum durability and longer lifetime.
- Lock with a speed thread* that allows faster blade adjustment.
- Auto-lock slide** for faster blade adjustment.
- Snap-off cap pocket clip** snaps off blade segments.
- Overmolded handle offers a slip resistant grip and is an acetone resistant.
- Iron carbide blade for longer lifetime, increased sharpness and clean cut finish.
- * 18 mm / 25 mm snap knives
- ** 9 mm snap knives



Description	Blade width (mm)	No. blade points	Pack quantity	Min. order quantity	Article Number	EAN Code
① Snap knife 9 mm	9	13	1	1	48221960	045242296811
② Snap knife 18 mm	18	8	1	1	48221961	045242296798
③ Snap knife 25 mm	25	7	1	1	48221962	045242296828

Snap blades

- Robust re-usable storage dispenser with easy access to blades.
- Optimized cutting angle geometry for sharpness and improved cutting precision.
- Iron carbide metal for longer life.
- Precise ground cutting edges for cleaner cuts.

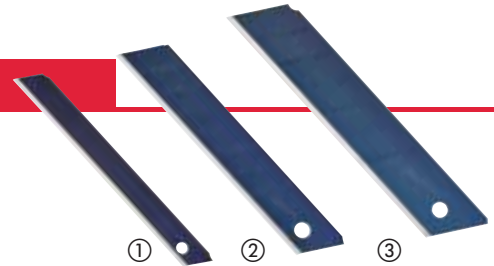

Description	Blade width (mm)	No. blade points	Pack quantity	Min. order quantity	Article Number	EAN Code
① Snap blades 9 mm	9	13	10	1	48229109	045242288649
② Snap blades 18 mm	18	8	10	1	48229118	045242288656
③ Snap blades 25 mm	25	7	10	1	48229125	045242288663

Safety cutter

- Reduce cut injuries thanks to recessed blade prevents contact with fingers.
- Reduce damaged goods in boxes or packages.
- Dual hook design lasts twice as long as single blade cutters.



Description	Pack quantity	Min. order quantity	Article Number	EAN Code
Safety cutter	1	1	48221916	045242495337

Rasping jab saw

- 150 mm plaster / drywall blade. Extra strong thicker blade making it more resistant for plunge cuts. Coated for corrosion protection.
- Coated for corrosion protection.
- Rubber overmould. Increased comfort and reduced hand slippage.
- Built in rasping holes. Allows user to rapidly expand holes or smooth rough edges.



6 pcs
master carton

Description	Pack quantity	Min. order quantity	Article Number	EAN Code
Rasping jab saw	1	6	48229304	045242480555

Jobsite scissors

- Iron carbide cutting edge for maximum durability. Longer lifetime vs. stainless steel.
- Chrome plated blades for maximum rust protection.
- All metal core: full metal handle construction to protect from drops and handle breakage.
- Bolt lock technology protects blades from loosening to ensure precise cutting.
- Large handle loops for use with gloves.
- Index finger groove for more comfort.
- Laser edged ruler markings on the blade allows to measure and cut in one go.
- Jobsite offset scissors with micro-serrated blades for maximum durability and better grip.
- Jobsite offset scissors with 60°-offset head allows to keep hand above cutting material.



Description	Total length (mm)	Blade length (mm)	Weight (g)	Pack quantity	Min. order quantity	Article Number	EAN Code
① Straight scissors	230	95	180	1	1	48224044	045242347483
② Offset scissors	240	115	230	1	1	48224043	045242347476

Metal snips

NEW

- Thumb and forefinger slots for increased comfort and less fatigue. Allows user to push through sheet metal with ease with less risk of cutting oneself.
- Serrated cutting edges prevent slippage when cutting.
- Less hand fatigue when cutting thicker materials. Design with compound leverage action.
- Torsion spring opens jaws automatic during cutting for faster cutting action and less fatigue work.
- Chrome plated rust protected forged blades for increased lifetime. Extra hardened to 65 HRC.
- Made from forged alloy steel for best durability – Cr Steel.
- One hand locking mechanism.
- Flush slimline design for non-snagging in material.
- Triple cutting direction identification – on the head, handle and by colour coded handle.
- Ergonomic and durable overmoulded grips add comfort and last longer.
- Aviation snips: For short, straight and shaped cuts. Ideal for narrow radius cuts and notch cuts.
- Offset snips: For long continuous straight or curved cuts. 45° offset keeps users hand away from the cutting material.
- Extra long aviation snips: for longer and straighter cuts in one go.

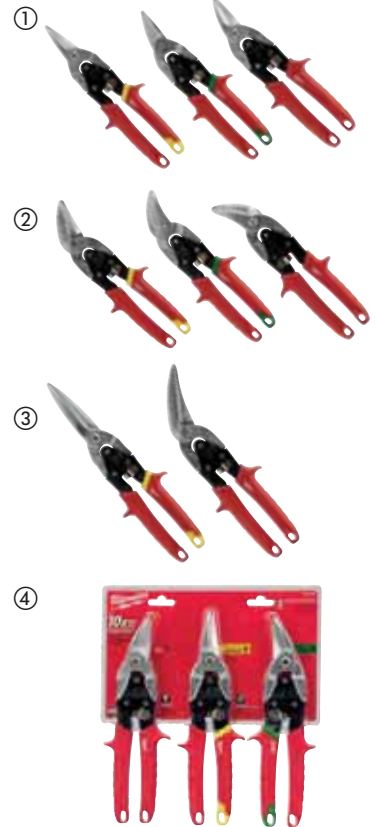

Cutting direction	Total length (mm)	Edge length (mm)	Max. cutting capacity aluminium (mm)	Max. cutting capacity stainless steel (mm)	Weight (g)	Pack quantity	Min. order quantity	Article Number	EAN Code
① Aviation snips: For short, straight and shaped cuts. Ideal for narrow radius cuts and notch cuts.									
Straight (yellow)	260	31	1.0	0.6	430	1	1	48224530	045242503643
Right (green)	260	31	1.0	0.6	430	1	1	48224520	045242503636
Left (red)	260	31	1.0	0.6	430	1	1	48224510	045242503629
② Offset snips: For long continuous straight or curved cuts. 45° offset keeps users hand away from the cutting material.									
Straight (yellow)	260	37	1.0	0.6	430	1	1	48224532	045242503674
Right (green)	260	30	1.0	0.6	430	1	1	48224522	045242503667
Left (red)	260	30	1.0	0.6	430	1	1	48224512	045242503650
③ Extra long aviation snips: for longer and straighter cuts in one go.									
Straight (yellow)	310	76	1.0	0.6	450	1	1	48224537	045242503681
Left (offset)	290	63	1.0	0.6	450	1	1	48224538	045242503698
④ Metal snips set.									
48224510, 48224530 and 48224520.						3	1	48224533	045242503735

Plastic cutter

- Cuts PEX, PB, MDP, PE, plastic electrical conduits, pneumatic pipe, plastic overflow pipe, rubber hoses, silicon hoses up to Ø 25 mm.
- V-shaped blade allows quick and straight cuts; prevents crushing of material.
- Replaceable stainless steel blade.
- Robust construction – metal core from the head to the handles for maximum lifetime.
- Grooves on the head allows stripping of couplings.
- Corrosion resistant head.
- One handed locking mechanism, tool remains closed while in pouch, spring loaded but easy opening.
- Ergonomic and durable overmoulded grips add comfort and last longer.



Description	Max. capacity tube & pipe Ø (mm)	Pack quantity	Min. order quantity	Article Number	EAN Code
Plastic cutter	25	1	1	48224202	045242343133
Replaceable blade		1	1	48224203	045242343140

Ratcheting PVC cutter

NEW

- Durable stainless steel rust proof blade for more cuts.
- Comfortable handle adds working comfort.
- Quick blade release adds working speed.
- One-handed metal lock.
- Lanyard hole, improves working security.
- Blades are replaceable.
- Suitable for: pvc, cpvc, pex, pp, pb, pvdf, pe.



Description	Max. capacity tube & pipe Ø (mm)	Pack quantity	Min. order quantity	Article Number	EAN Code
① Ratcheting PVC cutter 42 mm	42	1	1	4932464172	4058546221171
① Ratcheting PVC cutter 63 mm	63	1	1	4932464173	4058546221188
② Ratcheting PVC cutter blade 42 mm		1	1	48224211	045242477012
② Ratcheting PVC cutter blade 63 mm		1	1	48224216	045242477036

Cable cutter

- Best-in-class cut quality: beveled jaw heads. Accurate, smooth cable shearing.
- Comfort grips: more comfortable than dipped plastic. Grips will not peel.
- Forged design: tool durability in abusive environments.
- Rust protection: black oxide finish protects from rust.



Description	Pack quantity	Min. order quantity	Article Number	EAN Code
Cable cutter	1	1	48226104	045242356140

Nipping pliers

- Iron carbide edge: longer blade life.
- Comfort grips: more comfortable than dipped plastic. Grips will not peel.
- Smooth head. Will not mark surface during pull / pry applications.
- Forged design: tool durability in abusive environments.
- Rust protection: black oxide finish protect from rust.



Description	Length (mm)	Pack quantity	Min. order quantity	Article Number	EAN Code
Nipping pliers	180	1	1	48226407	045242356096

5IN1 wire stripping pliers

NEW

- Wire stripper : strips wire sizes : 0.75 mm², 1.0 mm², 1.5 mm², 2.5 mm², 4.0 mm².
- Wire cutter: with curved laser hardened cutting edges.
- Plier: suitable for gripping and bending cables.
- Deburrer: deburring ribs on head for 12 - 25 mm pipe.
- Loop maker: built in loop maker function for wire.
- One-handed swing lock: easy one-handed use and remains locked while in pouch. Spring loaded for easy opening.
- Rust protection: increases tool life by reducing corrosion.
- Forged alloy steel: for maximum tool strength and durability.



Total length (mm)	Stripping capacities (mm ²)	Cutting capacity in medium wire (mm)	Cut cap. in hard wire (mm)	Max. cutting capacity cable (mm)	Jaw thickness (mm)	Deburring head max. Ø (mm)	Pack quantity	Min. order quantity	Article Number	EAN Code
190	0.75, 1.0, 1.5, 2.5, 4.0	2.5	2.5	6.0	4	25	1	1	48229079	045242521272

Heavy Duty Lineman's pliers

- For universal gripping, cutting applications.
- High leverage design – long handles for maximum cutting power and leverage.
- Deburrer – Deburring ribs on head for up to 25 mm pipe. No need for extra tools.
- Nail puller – powerful gripping and high leverage.
- Laser hardened durable cutting edges: cuts wire, bolts, screws and nails. Extra hardened jaws to 64 HRC.
- Serrated gripping zone for strong gripping and pulling.
- Made from Chrome Vanadium steel for best durability and good rust protection.
- Ergonomic and durable overmoulded grips add comfort and last longer.
- With crimping facility.



Cut cap. in hard wire (mm)	Cutting capacity soft wire (mm)	Total length (mm)	Weight (g)	Deburring head max. Ø (mm)	Pack quantity	Min. order quantity	Article Number	EAN Code
3.0	4.6	250	480	25	1	1	48226100	045242342228

Long nose pliers

- Long nose pliers: specially suitable for gripping, bending and adjusting in restricted areas.
- Wire cutter: cuts wire up to 2.5 mm.
- Deburrer: deburring ribs on head for up to 20 mm pipe. No need for extra tools.
- Nail puller
- Serrated jaws for better grip and excellent control.
- Laser hardened durable cutting edges. Extra hardened to 64 HRC.
- Made from Chrome Vanadium for best durability and good rust protection.
- Ergonomic and durable overmoulded grips add comfort and last longer.



Total length (mm)	Cut cap. in hard wire (mm)	Cable diameter (mm)	Jaw length (mm)	Weight (g)	Deburring head max. Ø (mm)	Pack quantity	Min. order quantity	Article Number	EAN Code
210	2.5	6.0	51	255	18	1	1	48226101	045242342211

Diagonal pliers

- For all around cutting use.
- Tip protection – tips are off set ground to protect cutting edges from damage when dropped.
- High leverage design – long handles for maximum cutting power and leverage.
- Deburrer – Deburring ribs on head for up to 25 mm pipe. No need for extra tools.
- 15° offset head allows flush cutting, can be used as a nail puller for easier and quicker prying and pulling.
- Laser hardened durable cutting edges. Extra hardened to 64 HRC. Cuts wire, bolts, screws and nails.
- Made from forged alloy Chrome Vanadium steel for best durability and good rust protection.
- Ergonomic and durable overmoulded grips add comfort and last longer.



Total length (mm)	Cut cap. in hard wire (mm)	Cutting capacity soft wire (mm)	Jaw length (mm)	Weight (g)	Pack quantity	Min. order quantity	Article Number	EAN Code
160	2.5	4.0	22	195	1	1	48226106	045242342181
180	3.0	4.0	26	246	1	1	48226107	045242342198

Quick adjust water pump pliers

- For gripping, fastening and holding work pieces.
- One hand push button adjustment for fast and firm grip.
- Fine scale adjustment positions for precise grip. Less downtime and more efficiency.
- Self locking button for fast and firm adjustment.
- V-groove jaws with profile for firmer grip, more precise fit and reduced slipping. Special teeth hardening 60 HRC.
- Made from Nickel and Chrome forged alloy steel for best durability and good rust protection.
- Ergonomic and durable overmoulded grips add comfort and last longer.
- Deburring head and handle design. No need for extra tools.
- Available in 3 lengths for optimum leverage.
- Ergonomic slim design to allow access in confined areas.



Total length (mm)	Total length (inch)	Max. nut size AF (mm)	Max. capacity tube & pipe Ø (mm)	Weight (g)	Deburring head max. Ø (mm)	Deburring handles max. Ø (mm)	Pack quantity	Min. order quantity	Article Number	EAN Code
200	8	30	32	250	38	25	1	1	48226208	045242342235
250	10	36	42	425	51	25	1	1	48226210	045242342242
300	12	50	60	660	70	25	1	1	48226212	045242342259

TORQUE LOCK™ locking pliers

- TORQUE LOCK™: Faster set up and easy release when clamping flat and round material. Extra force can be applied to the TORQUE LOCK™ screw for better and more secure grip. Can also be used for hanging / storage purposes.
- Hardened jaws: better grip force on jobsite material.
- Rust protection: chrome plated tool increases life by reducing corrosion.
- Lever release design: traditional release lever for jobsite convenience.

	Total length (mm)	Total length (inch)	Jaw type	Jaw capacity flat (mm)	Jaw opening capacity for pipe (mm)	Pack quantity	Min. order quantity	Article Number	EAN Code
①	170	7	Maxbite™	–	38	1	1	48223607	045242358328
②	250	10	Maxbite™	–	50	1	1	48223610	045242358311
③	127	5	curved	–	26	1	1	48223422	045242358250
④	170	7	curved	–	38	1	1	48223421	045242358243
⑤	250	10	curved	–	51	1	1	48223420	045242325276
⑥	250	10	flat	30	–	1	1	48223510	045242324996
⑦	100	4	flat long nose	42	–	1	1	48223504	045242358281
⑧	150	6	flat long nose	52	–	1	1	48223506	045242358274
⑨	230	9	flat long nose	76	–	1	1	48223509	045242358267



TORQUE LOCK[™] locking C clamps

- TORQUE LOCK[™]: Faster set up and easy release when clamping flat and round materials for welding. Extra force can be applied to the TORQUE LOCK[™] screw for better and more secure grip. Can also be used for hanging / storage purposes.
- Hardened jaws: better grip force on jobsite material.
- Rust protection: chrome plated tool increases life by reducing corrosion.
- Lever release design: traditional release lever for jobsite convenience.



	Total length (mm)	Total length (inch)	Jaw type	Pack quantity	Min. order quantity	Article Number	EAN Code
①	230	9	Deept Reach regular pointed pads	1	1	48223533	045242472680
②	480	18	Deept Reach regular pointed pads	1	1	48223529	045242472697
③	280	11	Regular pointed pads	1	1	48223531	045242325115
④	480	18	Regular pointed pads	1	1	48223530	045242472673
⑤	230	9	Deep Reach swivel pads	1	1	48223523	045242358304
⑥	280	11	Swivel pads	1	1	48223521	045242325054
⑦	480	18	Swivel pads	1	1	48223520	045242358298

TORQUE LOCK[™]

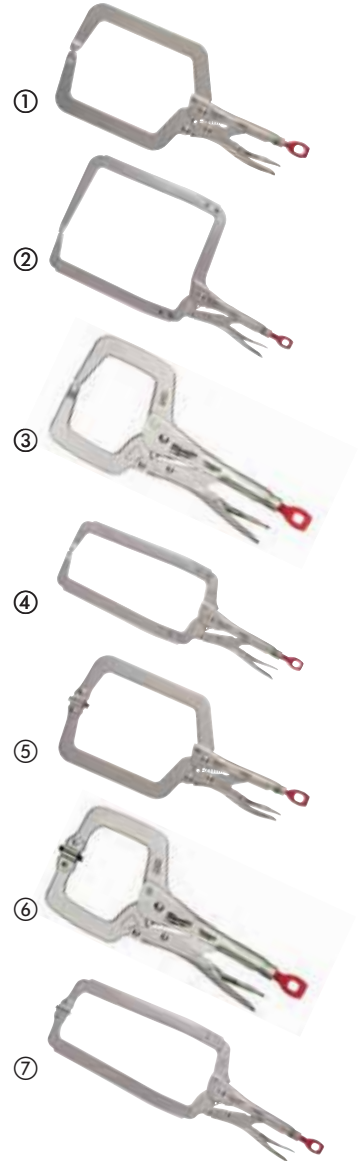

TORQUE LOCK[™] seamer

- TORQUE LOCK[™]: Faster set up and easy release when clamping flat material. Extra force can be applied to the TORQUE LOCK[™] screw for better and more secure grip. Can also be used for hanging / storage purposes.
- Hardened jaws: better grip force on jobsite material.
- Rust protection: chrome plated tool increases life by reducing corrosion.
- Lever release design: traditional release lever for jobsite convenience.
- The seamer makes all kinds of bendings, forming, crimping tasks with ease.
- It is ideal for holding sheet metal parts.



Description	Total length (mm)	Total length (inch)	Jaw capacity flat (mm)	Pack quantity	Min. order quantity	Article Number	EAN Code
TORQUE LOCK [™] seamer	200	8	42	1	1	48223540	045242358335

TORQUE LOCK™ chain wrench

- TORQUE LOCK™: Faster set up and easy release when clamping round material. Extra force can be applied to the TORQUE LOCK™ screw for better and more secure grip. Can also be used for hanging / storage purposes.
- Hardened jaws: better grip force on jobsite material.
- Rust protection: chrome plated tool increases life by reducing corrosion.
- Lever release design: traditional release lever for jobsite convenience.
- Locking chain wrench holds and locks around any shape object.
- It adjusts quickly for ratchet action in either direction.



Description	Total length (mm)	Total length (inch)	Jaw opening capacity for pipe (mm)	Pack quantity	Min. order quantity	Article Number	EAN Code
TORQUE LOCK™ chain wrench	270	9	79	1	1	48223542	045242472727

Combination spanner sets

NEW

- MaxBite open-end grip reduces rounding and stripping.
- Rounded I-Beam handle for comfortable handling grip.
- Optimised storage, 7 pc set with carry handle. 15 pc set in tray for easy storage in tool cabinet drawers.
- Ink-filled labels for better visibility.
- 15° offset box for better accessibility.
- Chrome alloy steel, chrome plated.

Description	Pack quantity	Min. order quantity	Article Number	EAN Code
7 pc metric combination spanner set.				
① 10, 11, 12, 13, 14, 15, 17 mm.	7	1	4932464257	4058546222024
15 pc metric combination spanner set.				
② 8, 9, 10, 11, 12, 13, 14, 15, 17, 18, 19, 20, 21, 22 mm.	15	1	4932464258	4058546222031
7 pc imperial combination spanner set.				
③ 3/4, 7/16, 1/2, 9/16, 5/8, 11/16, 3/4.	7	1	48229407	045242499038
15 pc imperial combination spanner set.				
④ 1/4, 9/32, 5/16, 11/32, 3/8, 7/16, 1/2, 9/16, 5/8, 11/16, 3/4, 13/16, 7/8, 15/16, 1.	15	1	48229415	045242499021



Cheater - adaptable pipe wrench

- New-to-world 3 length design - 10"/250 mm mode for tight spaces, 18"/450 mm mode for general purpose, 24"/600 mm mode for maximum leverage and reach.
- Overbite jaw for secure grip on pipes and fittings.
- Dual coil springs for maximum durability and tool life.
- Ergonomic handle for maximum comfort, won't dig into the palm.
- Ergonomic hook jaw design - for easy detachment from the workpiece.
- Hardened jaws for increased durability and better grip.
- Lanyard hole.



Description	Total length (mm)	Total length (inch)	Jaw opening capacity for pipe (mm)	Jaw opening capacity for pipe (inch)	Weight (g)	Pack quantity	Min. order quantity	Article Number	EAN Code
-------------	-------------------	---------------------	------------------------------------	--------------------------------------	------------	---------------	---------------------	----------------	----------

Adaptable pipe wrench	250/450/600	10/18/24	63	2.5	3243	1	1	48227314	045242342402
-----------------------	-------------	----------	----	-----	------	---	---	----------	--------------



Steel and aluminium pipe wrenches

- Overbite jaw for secure grip on pipes and fittings.
- Dual coil springs for maximum durability and tool life.
- Ergonomic handle for maximum comfort, won't dig into the palm.
- Hardened jaws for increased durability and better grip.
- Lanyard hole.

Description	Total length (mm)	Total length (inch)	Jaw opening capacity for pipe (mm)	Jaw opening capacity for pipe (inch)	Weight (g)	Pack quantity	Min. order quantity	Article Number	EAN Code
-------------	-------------------	---------------------	------------------------------------	--------------------------------------	------------	---------------	---------------------	----------------	----------

Aluminium pipe wrench 250 mm	250	10	38	1.5	907	1	1	48227210	045242342372
Aluminium pipe wrench 300 mm	300	12	51	2	1293	1	1	48227212	045242342389
① Aluminium pipe wrench 350 mm	350	14	51	2	1724	1	1	48227214	045242342396
Aluminium pipe wrench 450 mm	450	18	63	2.5	2699	1	1	48227218	045242342419
Aluminium pipe wrench 600 mm	600	24	76	3	680	1	1	48227224	045242342426
Steel pipe wrench 250 mm	250	10	38	1.5	794	1	1	48227110	045242342334
Steel pipe wrench 300 mm	300	12	51	2	1066	1	1	48227112	045242342341
② Steel pipe wrench 350 mm	350	14	51	2	1633	1	1	48227114	045242342358
Steel pipe wrench 450 mm	450	18	63	2.5	2676	1	1	48227118	045242342365



Adjustable wrenches

- Precision adjustment screw with accurate threads and tight tolerances. The jaws won't back off during use.
- Chrome plating for best-in-class rust protection and increased durability.
- Ergonomic rounded handle design for a comfortable fit in the hand and less pressure points on the palm.
- Slim head design for reaching into tight spaces.
- Parallel jaws won't slip or damage finish surfaces.
- Permanent lasered inch and mm markings for accurate adjustment.
- 8" adjustable wrench (48227508) has an extra wide jaw of 38 mm for increased jaw capacity in confined environments.
- Lanyard hole.



	Total length (mm)	Total length (inch)	Jaw opening capacity for pipe (mm)	Jaw thickness (mm)	Tip thickness (mm)	Weight (g)	Pack quantity	Min. order quantity	Article Number	EAN Code
	150	6	24.5	11.5	7.7	186	1	1	48227406	045242356225
	200	8	30	14	8.7	353	1	1	48227408	045242356218
①	200	8	40	14	8.1	385	1	1	48227508	045242356232
	250	10	36.5	16	9.9	535	1	1	48227410	045242356201
	300	12	42.5	17	10.8	748	1	1	48227412	045242356195
	380	15	46	22	13.5	1,470	1	1	48227415	045242356188
②	150 mm (48227406) and 250 mm (48227410)						2	1	48227400	045242358823



Basin wrench

- Ratchet-compatible design: accepts 3/8" ratchet.
- Hi-leverage design: achieve break-away torque on stuck fasteners.
- Door-knob handle: more comfortable than square.
- Easy to adjust handle: best-in-class adjustability.



Description	Jaw size (mm)	Pack quantity	Min. order quantity	Article Number	EAN Code
Basin wrench compact	10 - 32	1	1	48227001	045242366170
Basin wrench	32 - 65	1	1	48227002	045242366187

PVC saw

- All-metal handle design for best-in-class durability.
- Tool free blade change: up to 10x faster blade change.
- Overmold handle for increased comfort.
- Compact design.



Description	Pack quantity	Min. order quantity	Article Number	EAN Code
PVC saw	1	1	48220212	045242467518
PVC saw replacement blade	1	1	48220222	045242467532

Compact Hacksaw

- Tool free blade change for changing blades up to 10x faster.
- Compact design, ideal for versatile cutting in tight spaces.
- Adjustable blade length for easier flush cutting.
- Rubber overmould grip for increased ccomfort.
- Accepts 12" blades.



Description	Pack quantity	Min. order quantity	Article Number	EAN Code
Compact Hacksaw	1	1	48220012	045242204571

Folding jabsaw

- Tool free blade change - change blades up to 10x faster.
- Folding blade - easier and safer storage.
- Rubber overmould grip - increased comfort.
- Accepts all Sawzall® blades - increased versatility.
- Supplied with 18 TPI , 150 mm blade.



Description	Blade length (mm)	Pack quantity	Min. order quantity	Article Number	EAN Code
Folding Jab Saw	150	1	1	48220305	045242204618

Hacksaw

- Tough metal frame, supports higher tension (25,000 PSI / 250 lbs).
- Overmould handle ensures secure grip and user comfort.
- Internal blade storage for extra blades.
- Supplied with 12" / 24 Tpi blade.



Description	Pack quantity	Min. order quantity	Article Number	EAN Code
Hacksaw	1	1	48220050	045242362226

Mini copper tubing cutters

NEW

- Proprietary adjustment mechanism.
- Chrome rollers for added durability and extended performance provide best in class rust protection.
- Easy grip knob allows faster adjustment and easier one handed use.
- Compact design to cut pipes in restricted areas.



Description	Max. cutting capacity in copper pipe [mm]	Pack quantity	Min. order quantity	Article Number	EAN Code
Mini copper tubing cutter 15 mm	3 - 15	1	1	48229250	045242521210
Mini copper tubing cutter 22 mm	3 - 22	1	1	48229258	045242521258
Mini copper tubing cutters 28 mm	3 - 28	1	1	48229251	045242521227

Constant swing copper tubing cutters

NEW

- Constant swing copper tubing cutters are engineered for straighter, cleaner cuts.
- 4 roller design delivers accurate cuts and prevents walking.
- Chrome rollers for added durability and extended performance provide best in class rust protection.
- Smooth adjustment mechanism.
- On-board reamer enables fast, easy deburring.
- A spare wheel is integrated in the knob.



Description	Max. cutting capacity in copper pipe [mm]	Pack quantity	Min. order quantity	Article Number	EAN Code
Constant swing copper tubing cutter 28 mm	3 - 28	1	1	48229259	045242521265
Constant swing copper tubing cutter 42 mm	3 - 42	1	1	48229252	045242521234
Constant swing copper tubing cutter 67 mm	16 - 67	1	1	48229253	045242521241

Tubing cutter blades

NEW

- Replacement blades for tubing cutters.



Description	Pack quantity	Min. order quantity	Article Number	EAN Code
Tubing cutter blades for copper.	2	1	48224256	045242356256

Reaming pen

NEW

- Provides easy deburring of copper tubing and PVC.
- All-metal design for durability through demanding jobsite use.
- Heat treated and black oxide coated blade for extended life.
- A slide resistant clip allows easy storage in the users pocket or tool bag for quick access.



Description	Pack quantity	Min. order quantity	Article Number	EAN Code
① Reaming pen	1	1	48224255	045242356249
② Reaming blades	3	1	48224257	045242356263

10 in 1 Ratchet Multi-Bit screwdriver

- Ergonomic 152 mm long screwdriver with 1/4" Hex nut driver (in reception) and built in wire stripper and loop maker.
- Full metal high torque ratchet for 2 x driving speed and control.
- 88 mm long power groove bits, power tool compatibility.
- Precision hardened bit tips: durable driving tips for secure fitment and long life.
- Revolver style bit storage in handle.
- Chrome plated marine grade rust protected bits.



Description	Pack quantity	Min. order quantity	Article Number	EAN Code
10 in 1 Ratchet Multi-Bit screwdriver - universal				
PH1 / PH2 / PZ1 / PZ2 / TX15 / TX20 / Slotted 0.8 x 5.5 mm.	1	12	48222311	045242352135
10 in 1 Ratchet Multi-Bit screwdriver - Hex				
Hex 1.5 mm / Hex 2 mm / Hex 2.5 mm / Hex 3 mm / Hex 4 mm / Hex 5 mm / Hex 6 mm	1	12	48229306	045242467310



VDE screwdrivers

NEW

- VDE tested to 10, 000 V and guaranteed to 1,000 V.
- Premium quality steel with molybdenum and vanadium for flexibility and lifetime.
- CNC milled tips for high precision for best fit and reduced cammout effect.
- Black phosphate on the tip for grip and corrosion resistance.
- 2 component grip with softgrip for comfortable handling.
- 3 sided design for non slip and maximum power transfer.
- Slim design at front for low power/torque applications and fine electrical work.
- Laser engraved with the reception on the top of handle for easy identification.
- Anti roll, 3 sided collar on handle.



Description	Pack quantity	Min. order quantity	Article Number	EAN Code
SL 0.4 x 2.5 x 75	1	1	4932464034	4058546219796
SL 0.5 x 3 x 100	1	1	4932464035	4058546219802
SL 0.6 x 3.5 x 100	1	1	4932464036	4058546219819
SL 0.8 x 4 x 100	1	1	4932464037	4058546219826
SL 1.0 x 5.5 x 125	1	1	4932464038	4058546219833
SL 1.2 x 6.5 x 150	1	1	4932464039	4058546219840
SL 1.2 x 8 x 175	1	1	4932464040	4058546219857
SL 0.5 x 3 x 65	1	1	4932464041	4058546219864
PH0 x 60	1	1	4932464042	4058546219871
PH1 x 80	1	1	4932464043	4058546219888
PH2 x 100	1	1	4932464044	4058546219895
PH3 x 150	1	1	4932464045	4058546219901
PZ0 x 60	1	1	4932464046	4058546219918
PZ1 x 80	1	1	4932464047	4058546219925
PZ2 x 100	1	1	4932464048	4058546219932
PZ3 x 150	1	1	4932464049	4058546219949
T10 x 60	1	1	4932464050	4058546219956
T15 x 75	1	1	4932464051	4058546219963
T20 x 100	1	1	4932464052	4058546219970
T25 x 100	1	1	4932464053	4058546219987
T30 x 100	1	1	4932464054	4058546219994
PH/SL1 x 80	1	1	4932464055	4058546220006
PH/SL2 x 100	1	1	4932464056	4058546220013
PZ/SL1 x 80	1	1	4932464057	4058546220020
PZ2/SL2 x 100	1	1	4932464058	4058546220037
SW6 x 125	1	1	4932464059	4058546220044
SW7 x 125	1	1	4932464060	4058546220051
SW8 x 125	1	1	4932464061	4058546220068
SW9 x 125	1	1	4932464062	4058546220075
SW10 x 125	1	1	4932464063	4058546220082
SW11 x 125	1	1	4932464064	4058546220099
SW13 x 125	1	1	4932464065	4058546220105
VDE Screwdriver 5 pcs set				
SL3 / SL4, PZ1 / PZ2 and voltage tester.	5	1	4932464066	4058546220112
① VDE Screwdriver 7 pcs set 1				
SL2.5 / SL3 / SL4, PH2, PZ1 / PZ2 and voltage tester.	7	1	4932464067	4058546220129
VDE Screwdriver 7 pcs set 2				
SL2.5 / SL3 / SL4 / SL5.5, PH1 / PH2 and voltage tester.	7	1	4932464068	4058546220136



Hollowcore[™] magnetic nut drivers

- Hollowcore[™] unlimited depth in long bolts and threaded rod applications (patent pending).
- Magnetic retention driver heads for secure fitment in fastening applications.
- NEW TO WORLD universal driver head fits 4 x more fasteners - square, 12 point, 8 point, Hex.
- Removes rusted and stripped bolts.
- Color coded ID markings allow for quick tool identification on jobsite.
- Wrench ready Hex shanks deliver additional leverage.
- Chrome plated for maximum durability.
- Forged steel shanks provide longer life and more durability.



	Size (mm)	Colour code	For anchor rod thread size	Pack quantity	Min. order quantity	Article Number	EAN Code
①	5	Black		1	1	48222531	045242294428
②	5.5	Brown	M3	1	1	48222532	045242294435
③	6	Red	M3.5	1	1	48222533	045242294442
④	7	Orange	M4	1	1	48222534	045242294459
⑤	8	Yellow	M5	1	1	48222535	045242294466
⑥	10	Blue	M6	1	1	48222536	045242294473
⑦	13	Orange	M8	1	1	48222537	045242294480

Hook & pick set

NEW

- All-metal core for more durability and rust protection.
- Chrome-plated shanks reduce corrosion and provide superior rust protection.
- Comfort grip handle and precision knurling increase tool control and user comfort.
- Supplied in an easy-access storage tray for long-term tool storage.



Description	Pack quantity	Min. order quantity	Article Number	EAN Code
Hook & pick set	4	1	48229215	045242508105



Staple gun

- Dual mode power switch: - High power drives staples flush in jobsite material. - Low power for driving control.
- 30 degree bevelled driving edge: - Easy firing leverage and drives staples flush, even when stapler is held at an angle.
- Integrated staple puller: - Removes proud staples from work surface.
- Flush drive surface: - Allows users to safely drive staples with the rear of the tool.
- Belt clip: Easily store on pouch, belt, bag or ladder.
- Staples 6 / 8 / 10 / 12 / 14 mm (10.6 mm wide)
- Type 50 / Rapid No. 140 - Arrow T50 - Novus Type 11 G - Tacwise Type 140 - Stanley Type G
- Nails 12 / 16 mm (18 gauge / 1.02 mm thick)
- Arrow BN 1810 - Novus Type J E - Stanley



Description	Pack quantity	Min. order quantity	Article Number	EAN Code
Staple gun	1	1	48221010	045242323807

Hammer tacker

- Reinforced frame: - Durable construction survives repeated drops from 10 ft.
- Protected staple magazine: - Easy access for re-loading. - Protects magazine from damage. - Fast reloading and easy jam clearance.
- Integrated staple puller: Removes proud staples from work surface.
- Flush drive surface: - Allows users to safely drive staples with the rear of the tool.
- Staples 8 / 10 / 12 mm (10.6 mm wide)
- Type 50 / Rapid No. 53 - Arrow T50 - Novus Type 11 G - Tacwise Type 140 - Stanley Type G



Description	Pack quantity	Min. order quantity	Article Number	EAN Code
Hammer tacker	1	1	48221020	045242323814

Tradesman 3/8" ratchet set

NEW

- Pivoting ratchet head.
- Slim profile design for better access.
- Wrench compatible sockets for better torque.
- Organised and portable storage solution.



Description	Pack quantity	Min. order quantity	Article Number	EAN Code
Tradesman 3/8" ratchet set.				
3/8" ratchet, 10, 12, 13, 14, 15, 17, 18 and 19 mm 3/8" sockets.	12	1	48229001	045242495078

Demolition Gloves

- Armortex® reinforced palms and finger tips. Increased durability and hand protection.
- Smartswipe™ Knuckle. Capacitive knuckle allows to use touch screen devices without removing gloves or using dirty fingertips.
- Breathable tri-cot lining. Provides ultimate comfort and breathability.
- Knuckle protection. TPR pad provides knuckle protection.
- Terry cloth thumb. Built in sweat/brow wipe.
- Hook & Loop closure for secure fit.
- Fulfill the requirements of CE Category 2, EN 420 and EN 388 – 2221.



Description	Pack quantity	Min. order quantity	Article Number	EAN Code
Size 8 / M	1	1	48229731	045242479436
Size 9 / L	1	1	48229732	045242479443
Size 10 / XL	1	1	48229733	045242479450
Size 11 / XXL	1	1	48229734	045242479467



Fingerless gloves

- Designed to provide ultimate dexterity when handling small objects.
- Reinforced palm and thumb seam.
- Lightweight, breathable backing.
- Moisture wicking lining provides all day comfort.
- Built-in sweat wipe.
- Hook & Loop closure for secure fit.
- Fulfill the requirements of CE Category 2, EN 420 and EN 388



Description	Pack quantity	Min. order quantity	Article Number	EAN Code
Size 8 / M	1	1	48229741	045242508730
Size 9 / L	1	1	48229742	045242508747
Size 10 / XL	1	1	48229743	045242508754
Size 11 / XXL	1	1	48229744	045242508761

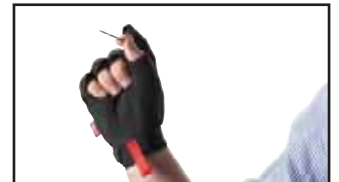

FREE-FLEX work gloves

- SMARTSWIPE™ knuckle, palm and fingertips.
- Flexible and elastic gloves.
- Lightweight, breathable backing.
- Reinforced thumb seam.
- High dexterity finger tips.
- Built-in sweat wipe.
- Fulfill the requirements of CE Category 2, EN 420 and EN 388



Description	Pack quantity	Min. order quantity	Article Number	EAN Code
Size 8 / M	1	1	48229711	045242508693
Size 9 / L	1	1	48229712	045242508709
Size 10 / XL	1	1	48229713	045242508716
Size 11 / XXL	1	1	48229714	045242508723



Jobsite backpack

- Durable construction, made from 1680D ballistic nylon.
- Hard moulded base allows bag to stand-up and provides ultimate all-weather protection.
- Padded, breathable straps for ultimate comfort and jobsite performance.
- Large storage - 35 pockets in total.
- Fold down front pocket for easier access and storage of larger items. Side water bottle pocket.
- Vertical tool wall maximizes storage space while allowing for bulk storage space.
- Laptop pocket allows protected storage for laptops/tablets and personal goods.
- Exterior daisy chains allow clip on storage.



Description	Pack quantity	Min. order quantity	Article Number	EAN Code
-------------	---------------	---------------------	----------------	----------

Jobsite backpack	1	1	48228200	045242333943
------------------	---	---	----------	--------------



Tradesman backpack

NEW

- Durable construction, made from 1680D ballistic nylon.
- Padded straps for more comfort and jobsite performance.
- Laptop pocket allows protected storage for laptops/tablets and personal goods.
- 18 organizer pockets allow variety of options.



Description	Pack quantity	Min. order quantity	Article Number	EAN Code
-------------	---------------	---------------------	----------------	----------

Tradesman backpack.	1	1	4932464252	4058546221973
---------------------	---	---	------------	---------------

Electricians pouch

- Robust construction, made from 1680D ballistic nylon.
- Double stitched with stronger riveted seams.
- Integrated handle allows easy transport and provides an easy mounting point on common jobsite materials.
- Solid base allows bag to stand-up, even when fully loaded.
- Integrated belt loops allow bag to be worn on a tool belt.
- Center mounted metal D-rings allow bag to hang evenly from shoulder strap.
- Metal tape measure clip securely stores tape for easy access.



Description	Pack quantity	Min. order quantity	Article Number	EAN Code
Electricians pouch	1	1	48228112	045242509157

Contractor rig

- Robust construction, made from 1680D ballistic nylon.
- Double stitched with stronger riveted seams.
- Padded 4-point harness distributes weight for all day comfort.
- Padded, breathable belt for ultimate comfort and jobsite performance.
- Integrated handle allows easy transport of the pouch and provides easy mounting point on common jobsite materials.
- Metal suspender attachments allow suspenders to be added.



Description	Pack quantity	Min. order quantity	Article Number	EAN Code
Contractor rig	1	1	48228120	045242333974

Padded rig

- Adjustable straps designed to fit all users.
- 1680D ballistic material construction.



Description	Pack quantity	Min. order quantity	Article Number	EAN Code
Padded rig	1	1	48228145	045242358212

Work belt

NEW

- Metal hardware and 1680D ballistic nylon provide a lifetime of service.
- Up to 152 mm (6") of padding and can accommodate waist sizes up to 143 mm (53")



Description	Pack quantity	Min. order quantity	Article Number	EAN Code
Work belt	1	1	48228140	045242358168

Bucket organiser

NEW

- Bucket can be reordered under 4931453956.



Description	Pack quantity	Min. order quantity	Article Number	EAN Code
Bucket organiser	5	1	4932459430*	4058546010911

* while stocks last

PACKOUT[™]

MODULAR STORAGE SYSTEM



PACKOUT[™] trolley box

NEW

- Part of the PACKOUT[™] modular storage system.
- Constructed with impact resistant polymers for jobsite durability.
- 113 kg weight capacity.
- Industrial grade extension handle.
- Oversized Ø 228 mm all terrain wheels.
- IP65 rated weather seal to keep out rain and jobsite debris.
- Metal reinforced corners.
- Metal reinforced locking point.
- Interior organiser tray.
- Mounting location for the ONE-KEY[™] TICK[™].



Description	Dimensions (mm)	Pack quantity	Min. order quantity	Article Number	EAN Code
PACKOUT [™] trolley box	560 x 410 x 480	1	1	4932464078	4058546220235

PACKOUT™ box

NEW

- Part of the PACKOUT™ modular storage system.
- Constructed with impact resistant polymers for jobsite durability.
- IP65 rated weather seal to keep out rain and jobsite debris.
- Metal reinforced corners.
- Metal reinforced locking point.
- Interior organiser trays.
- Mounting location for the ONE-KEY™ TICK™.
- Metal reinforced top handle for easier carrying (only on the large box)

Description	Dimensions (mm)	Pack quantity	Min. order quantity	Article Number	EAN Code
① PACKOUT™ large box	560 x 410 x 290	1	1	4932464079	4058546220242
② PACKOUT™ box	560 x 410 x 170	1	1	4932464080	4058546220259



PACKOUT™ organiser

NEW

- Part of the PACKOUT™ modular storage system.
- Constructed with impact resistant polymers for jobsite durability.
- The interior features 10 removable & mountable bins that can be mounted onto common jobsite materials for easy access.
- IP65 rated weather seal to keep out rain and jobsite debris.
- No-travel bins seals to prevent the bins contents from migrating between bins during transport.

Description	Dimensions (mm)	Pack quantity	Min. order quantity	Article Number	EAN Code
PACKOUT™ organiser	500 x 380 x 120	1	1	4932464082	4058546220273



PACKOUT™ compact organiser

NEW

- Part of the PACKOUT™ modular storage system.
- Constructed with impact resistant polymers for jobsite durability.
- The interior features 5 removable & mountable bins that can be mounted onto common jobsite materials for easy access.
- IP65 rated weather seal to keep out rain and jobsite debris.
- No-travel bins seals to prevent the bins contents from migrating between bins during transport.

Description	Dimensions (mm)	Pack quantity	Min. order quantity	Article Number	EAN Code
PACKOUT™ compact organiser	250 x 380 x 120	1	1	4932464083	4058546220280



PACKOUT™ Tote toolbag

NEW

- Part of the PACKOUT™ modular storage system.
- 1680 ballistic material construction.
- Impact resistant molded base.
- All metal hardware.
- Durable overmolded handle.

Description	Dimensions (mm)	No. of pockets	Pack quantity	Min. order quantity	Article Number	EAN Code
25 cm tote toolbag	250 x 280 x 320	28	1	1	4932464084	4058546220297
40 cm tote toolbag	250 x 400 x 320	31	1	1	4932464085	4058546220303
50 cm tote toolbag	250 x 500 x 320	32	1	1	4932464086	4058546220310



Heavy Duty accessory sets

NEW

- Compatible with HD tools boxes.
- Mix of drilling and driving accessories in best Milwaukee® quality.
- Shockwave screwdriving bits for heavy duty impact applications.
- Thunderweb HSS-G metal drill bits DIN 338 for drilling in very hard materials. Long lasting bits with 135° split point for precision starting.
- Masonry drill bits with round shank for brick, slate, aerated concrete blocks.
- Lip and spur / brad point bits for wood for drilling hardboard, plywood, chipboard and all natural hard nad soft wood.
- Flat boring bits (only available in 100 pc set 4932464146) for fast wood drilling of big diameters.

Description	Pack quantity	Min. order quantity	Article Number	EAN Code
<p>50 pc Heavy Duty accessory set.</p> <p>Shockwave Impact Duty™ screwdriving bits 34 x 25 mm length: 1 x PH1 / 1 x PH2 / 1 x PH3, 1 x PZ1 / 6 x PZ2 / 1 x PZ3, 6 x TX10 / 6 x TX15 / 2 x TX20 / 2 x TX25 / 2 x TX30 / 1 x TX 40, 1 x Hex 3 mm / 1 x Hex 4 mm / 1 x Hex 5 mm / 1 x Hex 6 mm, 1 x magnetic bit holder 60 mm length. THUNDERWEB HSS-G drill bits 7 pcs: 2.0 mm / 2.5 mm / 3.0 mm / 3.5 mm / 4.0 mm / 5.0 mm / 6.0 mm. Masonry drill bits 3 pcs: Ø 5 mm / 6 mm / 8 mm. Wood drill bits 5 pcs: Ø 3 mm / 4 mm / 5 mm / 6 mm / 7 mm.</p>	50	6	4932464144	4058546220891
<p>100 pc Heavy Duty accessory set.</p> <p>Shockwave Impact Duty™ screwdriving bits 77 x 25 mm length: 4 x PH1 / 7 x PH2 / 3 x PH3, 4 x PZ1 / 8 x PZ2 / 4 x PZ3, 10 x TX10 / 10 x TX15 / 8 x TX20 / 6 x TX25 / 2 x TX30 / 3 x TX 40, 1 x Hex 3 mm / 1 x Hex 4 mm / 1 x Hex 5 mm / 1 x Hex 6 mm, 1 x magnetic bit holder 60 mm length. THUNDERWEB HSS-G drill bits 13 pcs: Ø 2.0 mm (2) / 2.5 mm (2) / 3.0 mm (2) / 3.5 mm (2) / 4.0 mm / 5.0 mm / 6.0 mm / 7.0 mm / 8.0mm. Masonry drill bits 4 pcs: Ø 5 mm / 6 mm (2) / 8 mm. Wood drill bits 5 pcs: Ø 3 mm / 4 mm / 5 mm / 6 mm / 7 mm.</p>	100	6	4932464145	4058546220907
<p>Heavy Duty box for accessory set.</p>	1	1	4932464147	4058546220921

①



②



Transport cases

Description		Metal/ Plastic	Pack quantity	Min. order quantity	Article Number	EAN Code	
Transport case for hammers.	K 900,K 950	Plastic case	1	1	4931375502	4002395752881	
Transport case for sabre saws / SAWZALLS®.	SSE 1000 AVS,SSE 1000 SQ,SSE 1000 QX, SSPE 1000 QX,SSD 1100 X,SSPE 1300 QX, SSPE 1300 SQ,M18 FUEL™ SAWZALL, SSDE 1500 X,V18 SX,V28 SX	Plastic case	1	1	48556510	045242148424	
Transport case for wall chasers.	WCE 30,WCS 45, DME 30,DME 45	MFE 1500,MFE 1305, MF 1900	Metal case	1	1	4932383357	4002395357390

Heavy Duty boxes

■ Cases supplied with latches and foam.

HD Box Size	Dimensions (mm)	Pack quantity	Min. order quantity	Article Number	EAN Code
1	475 x 358 x 132	1	1	4932453385	4002395146376
2	475 x 358 x 192	1	1	4932449767	4002395146383
3	475 x 358 x 230	1	1	4932453386	4002395143634
Accessories HD Box organisers		1	1	4932451545	4002395146581
HD Box 1 Universal. Supplied with foam insert.		1	1	4932459751	4058546029234
HD Box 1 Universal with FUEL logo. Supplied with foam insert.		1	1	4932459206	4002395287215
Spare latches.		2	1	4932373252	4002395347247
PACKOUT™ adaptor HD box.		1	1	4932464081	4058546220266



Inserts for Heavy Duty boxes

HD Box Insert	Pack quantity	Min. order quantity	Article Number	EAN Code
1	1	1	4932440936	4002395147588
3	1	1	4932453379	4002395148202
8	1	1	4932453508	4002395146390
9	1	1	4932453507	4002395143603
10	1	1	4932453509	4002395143610
11	1	1	4932453510	4002395143627
12	1	1	4932453859	4002395275649
13	1	1	4932453855	4002395275656
14	1	1	4932453856	4002395275663
15	1	1	4932453857	4002395275670
16	1	1	4932453858	4002395275687
17	1	1	4932453860	4002395275694
HD Box accessories insert	1	1	4932451546	4002395146598



HD Box Insert	HD Box Size	Fits Milwaukee® kits	Article Number	EAN Code
1	1	M18 CDD-202X, M18 CPD-202X, M18 CDD-502X, M18 CPD-502X, M18 CIW12-502X, M18 CID-202X, M18 CID-502X	4932440936	4002395147588
3	1	M18 FDD-202X, M18 FDD-502X, M18 FPD-202X, M18 FPD-502X, M18 ONEPD-502X, M18 ONEDD-502X	4932453379	4002395148202
8	1	M18 CHIWF12-502X, M18 CHIWF34-502X, M18 CHIWP12-502X	4932453508	4002395146390
9	1	M18 CAG115X-502X, M18 CAG125X-502X, M18 CAG125XPD-502X	4932453507	4002395143603
10	1	M18 CRAD-502X	4932453509	4002395143610
11	1	M18 FWF12-502X, M18 FID-502X, M18 ONEID-502X, M18 ONEIWP-502X, M18 ONEIWF-502X	4932453510	4002395143627
12	3	M18 CCS66-502X	4932453859	4002395275649
13	3	M18 CHX-502X	4932453855	4002395275656
14	3	M18 CHPX-502X	4932453856	4002395275663
15	3	M18 CSX-502X	4932453857	4002395275670
16	3	M18 CCS55-502X	4932453858	4002395275687
17	3	M18 CAG125XPDB-502X, M18 CAG115XPDB-502X	4932453860	4002395275694
HD Box accessories insert			4932451546	4002395146598



TITANIUM TOOLS

Since 1849 Stiletto® tools has been renowned worldwide from premium quality professional tools. Stiletto® was the first company to introduce Titanium hammers, the product line of today combines the latest technology in materials, design and balance to give professional users extra power, effortless striking and overall higher productivity.

Durability: More flexible and fracture resistant than steel. Accepts harder impacts without distorting the overall shape of the hammer. One-piece design – strength built in from the head right through to the handle providing for best stability.

Rust resistant: Hammers are predominantly used outdoors. Titanium is 100% corrosion resistant.

Less fatigue: Titanium weighs 45% less than steel. Titanium has the highest strength to weight ratio of any metal. Less weight allows one to swing the hammer faster creating greater head speed resulting in more power. Titanium hammers drive 30% more nails with the same effort. Light hammer can be swung faster, it puts less strain on the body without compromising work efficiency.

Less arm pain and vibration: Titanium provides 10 times greater dampening of harmful recoil shock vibrations compared to steel. Excessive hammer use can cause long term damage to the arm.

More productivity: Drives up to 30% more nails with the same effort.

100% Titanium TiBone™ hammers

Strongest handle: All titanium one piece frame. 200% stronger than wood.

Longer lifetime: Replaceable faces instead of replacing the complete hammer.

Pulls nails easier: Patented 180° side nail puller.

Magnetic nail starter: Helps to start nails in difficult to reach places.

Description	Weight (g)	Replace-able face	Face type	Length (mm)	Pack quantity	Min. order quantity	Article Number	EAN Code
① TB 15 MC + TBM-SR.	425	Yes	Supplied with milled and smooth face	457	1	1	4932352578	4002395372362
② TBM 14 RMC + TBM-SR.	397	Yes	Supplied with milled and smooth face	388	1	1	4932352579	4002395372379



Titanium hammers with wood handles

Traditional hickory wood handle: Strong curved axe type grip for comfortable handling.

Magnetic nail starter: Helps to start nails in difficult to reach places.

Low weight: Due to the natural wood handle a very lightweight hammer but still incredibly powerful.

Description	Weight (g)	Face type	Length (mm)	Pack quantity	Min. order quantity	Article Number	EAN Code
① Ti 14MC-H18	397	Milled	457	1	1	4932352583	4002395372416
② Ti 14SC-H18	397	Smooth	457	1	1	4932352584	4002395372423
③ Ti 14MC-H16	397	Milled	406	1	1	4932352585	4002395372430
④ Ti 14SC-H16	397	Smooth	406	1	1	4932352586	4002395372447



Spare parts

Description	Pack quantity	Min. order quantity	Article Number	EAN Code
① TBM-MR 3 oz Steel milled replacement face for TB15MC and TBM14RMC.	1	1	4931428165	4002395835003
② TBM-SR 3 oz Steel smooth replacement face for TB15MC and TBM14RMC.	1	1	4931428166	4002395835010
TBR-B Replacement bolt kit for TB15MC and TBM14RMC. 1 x bolt, 1 x washer, 1 x allen key, 1 x loctite tube, 1 x instruction manual.	5	1	4931428167	4002395835027
Handle H18 [™] 18" hickory replacement curved handle for 14 oz heads.	1	1	4931428170	4002395835058
Handle H16 [™] 16" hickory replacement curved handle for 14 oz heads.	1	1	4931428171	4002395835065



Curved hammer

NEW

- Precise balance for better handling.
- Durable grip construction.
- I-Beam handle construction resists bending in prying applications.
- Curved claw hammer reduces damage when pulling nails.
- Magnetic nail starter for safer application.

Description	Pack quantity	Min. order quantity	Article Number	EAN Code
20 oz /14" curved claw hammer.	1	1	4932464028	4058546219734



Accessories Merchandising Solutions



Whatever the space, we have the solution...

Milwaukee® offers a comprehensive range of merchandising systems to ensure the optimum display of accessories in store. 1 m rows offer a great solution that is easy to implement straight from delivery and the new Red Rack system fits on most merchandising walls and allows for effective category management of accessories.



A wide range of counter displays offer a flexible solution at point of purchase, or can be placed on the base shelves of the wall units.

SDS-Plus MX4 4 cut drill bits 1 metre row



Pos	Ø mm	A mm	B mm	Quantity	Id. No. 4932	EAN Code 4002395
1	5	115	50	5	352007	366644
2	6	115	50	5	352011	368921
3	6	165	100	5	352012	368938
4	6	215	150	5	352013	366705
5	6	265	200	5	352014	366712
6	8	115	50	5	352021	366781
7	8	165	100	5	352022	366798
8	8	215	150	5	352023	366804
9	8	265	200	5	352024	366811
10	10	110	50	5	352025	366828
11	10	160	100	5	352026	366835
12	10	210	150	5	352027	366842
13	10	260	200	5	352028	366859
14	12	160	100	5	352031	366880
15	12	210	150	5	352032	366897
16	12	260	200	5	352033	366903
17	14	160	100	5	352036	366934
18	14	210	150	5	352037	366941

4932 430493
4002395 381548

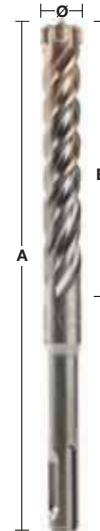

Pos	Display material	Quantity	Id. No. 4939	EAN Code 4002395
1	1 m Assembled row	1	434656	557967
2	Euro hook (short)	18	434650	557905
3	Milwaukee® header strip	1	510100	900596
4	Barcode label strip MX4 drill bits EU	1	565571	937516
5	Carton	1	4931373861	734399

SDS-Plus M2 2 cut drill bits 1 metre row



Pos	Ø mm	A mm	B mm	Quantity	Id. No. 4932	EAN Code 4002395
1	4	110	50	5	339498	304561
2	5	110	50	5	307067	308835
3	6	110	50	5	307068	308842
4	6	160	100	5	307069	308859
5	6	260	200	5	353819	320127
6	8	110	50	5	307070	308866
7	8	160	100	5	307071	308873
8	8	210	150	5	307072	308880
9	8	260	200	5	353821	320141
10	10	110	50	5	340410	311934
11	10	160	100	5	307073	308897
12	10	210	150	5	307074	308903
13	10	260	200	5	344295	312252
14	12	160	100	5	307075	308910
15	12	210	150	5	307076	308927
16	14	160	100	5	307078	308941
17	16	210	150	5	307081	308972
18	18	210	150	3	344303	312177
19	20	210	150	3	344305	312153

4932 430494
4002395 381555

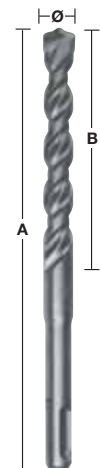

Pos	Display material	Quantity	Id. No. 4939	EAN Code 4002395
1	1 m Assembled row	1	434656	557967
2	Euro hook (short)	19	434650	557905
3	Milwaukee® header strip	1	510100	900596
4	Barcode label strip SDS-plus drill bits EU	1	530434	914135
5	Carton	1	4931373861	734399

SDS-Plus M2 2 cut drill bits long 1 metre row



Pos	Ø mm	A mm	B mm	Quantity	Id. No. 4932	EAN Code 4002395
1	8	460	400	5	367013	336692
2	10	310	250	5	353824	320172
3	10	450	400	5	344296	312245
4	12	260	200	5	344297	312238
5	12	450	400	5	307077	308934
6	14	260	200	5	307079	308958
7	14	450	400	5	307088	309047
8	15	260	200	5	344300	312207
9	16	310	250	5	344301	312191
10	16	450	400	5	307082	308989
11	18	250	200	3	307083	308996
12	18	450	400	3	340411	311941
13	20	250	200	3	307084	309009
14	20	450	400	2	307085	309016
15	22	450	400	3	344307	312139
16	24	450	400	3	307087	309030

4932 430495
4002395 381562

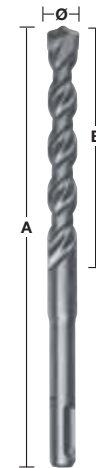
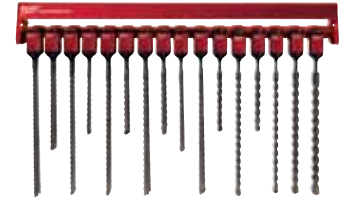

Pos	Display material	Quantity	Id. No. 4939	EAN Code 4002395
1	1 m Assembled row	1	434656	557967
2	Euro hook (short)	16	434650	557905
3	Milwaukee® header strip	1	510100	900596
4	Barcode label strip SDS-plus drill bits long EU	1	530436	914135
5	Carton	1	4931373861	734399

SDS-Plus M2 2 cut drill bits & chisels 1 metre row



Pos	Ø mm	A mm	B mm	Quantity	Id. No. 4932	EAN Code 4002395
① 1	5	110	50	5	307067	308835
2	6	110	50	5	307068	308842
3	6	160	100	5	307069	308859
4	8	110	50	5	307070	308866
5	8	160	100	5	307071	308873
6	8	210	150	5	307072	308880
7	10	160	100	5	307073	308897
8	10	210	150	5	307074	308903
9	12	160	100	5	307075	308910
10	14	160	100	5	307078	308941
11	16	210	150	5	307081	308972
12	18	210	150	3	344303	312177
13	20	210	150	3	344305	312153

4932 430496
4002395 381579

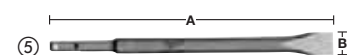
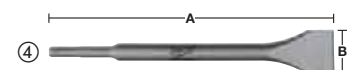
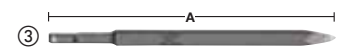
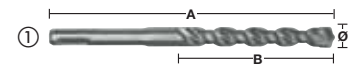

② 14	7pc SDS-plus 2 cut set with Ø 5/6/8x110 mm and Ø 6/8/10/12x160 mm			3	352339	369980
③ 15	Pointed chisel	250	-	5	339625	304813
④ 16	Wide chisel	250	40	5	367146	334377
⑤ 17	Flat chisel	250	20	5	339626	304820

Pos	Display material	Quantity	Id. No. 4939	EAN Code 4002395
1	1 m Assembled row	1	434656	557967
2	Euro hook (short)	17	434650	557905
3	Milwaukee® header strip	1	510100	900596
4	Barcode label strip SDS-plus drill bits & chisels EU	1	530442	914005
5	Carton	1	4931373861	734399

SDS-Max drill bits & chisels 1 metre row

Pos	Ø mm	A mm	B mm	Quantity	Id. No. 4932	EAN Code 4002395	
①	1	16	340	200	3	352756	374144
	2	16	540	400	2	352757	374151
	3	18	540	400	3	352761	374199
	4	20	520	400	3	352765	374236
	5	22	520	400	3	352769	374274
	6	24	520	400	2	352773	374311
	7	25	520	400	2	352775	374335
	8	28	570	450	2	352779	374373
	9	30	570	450	2	352784	374427
	10	32	570	450	1	352786	374441
	11	35	570	450	2	352790	374489
②	12	Pointed chisel	280	-	3	343734	317509
	13	Pointed chisel	400	-	3	343735	317516
③	14	Flat chisel	280	25	3	343737	317530
	15	Flat chisel	400	25	3	343738	317547
④	16	Wide chisel	400	50	3	343743	317592
	17	Wide chisel	300	80	3	343744	317608

Pos	Display material	Quantity	Id. No. 4939	EAN Code 4002395
1	1 m Assembled row	1	434656	557967
2	Euro hook (short)	6	434650	557905
3	Single hook (short)	11	434652	557929
4	Milwaukee® header strip	1	510100	900596
5	Barcode label strip SDS-Max drill bits & chisels EU	1	530294	914838
6	Carton	1	4931373861	734399

4932 430497
4002395 381586

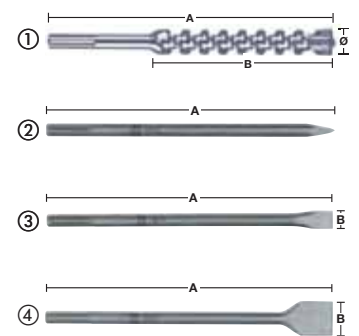

SDS-plus & SDS-Max chisels 1 metre row

Pos	Type	A mm	B mm	Quantity	Id. No. 4932	EAN Code 4002395	
SDS-plus							
①	1	Pointed chisel	250	-	5	339625	304813
②	2	Wide chisel	250	40	5	367146	334377
③	3	Flat chisel	250	20	5	339626	304820
④	4	Chasing goug. chisel	250	25	3	339627	304837
⑤	5	Tile chisel	250	40	3	353424	320202
SDS-Max							
①	6	Pointed chisel	280	-	4	343734	317509
①	7	Pointed chisel	400	-	4	343735	317516
①	8	Pointed chisel	600	-	3	343736	317523
②	9	Flat chisel	280	25	5	343737	317530
③	10	Flat chisel	400	25	5	343738	317547
③	11	Flat chisel	600	25	3	343739	317554
②	12	Wide chisel	400	50	4	343743	317592
②	13	Wide chisel	300	80	4	343744	317608
②	14	Wide chisel	300	115	3	343745	317615

Pos	Display material	Quantity	Id. No. 4939	EAN Code 4002395
1	1 m Assembled row	1	434656	557967
2	Euro hook (short)	14	434650	557905
3	Milwaukee® header strip	1	510100	900596
4	Barcode label strip SDS-plus & SDS-Max chisels EU	1	530297	914807
5	Carton	1	4931373861	734399

4932 430498
4002395 381593

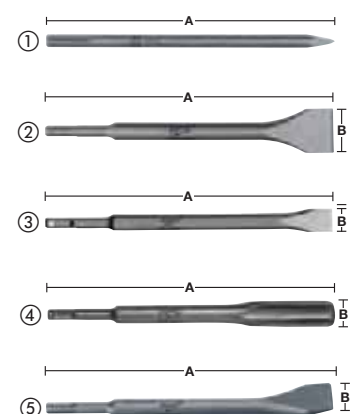

Concrete drill bits round shank - DIN 8039 - 1 metre row

Pos	Ø mm	A mm	B mm	Quantity	Id. No. 4932	EAN Code 4002395
① 1	4	85	50	5	363631	332014
2	5	85	50	5	363633	332038
3	5	150	90	5	363634	332045
4	6	100	60	5	363636	332069
5	6	150	90	5	363637	332076
6	8	120	80	5	363640	332106
7	8	200	150	5	363641	332113
8	9	120	80	5	363643	332137
9	10	120	80	5	363644	332144
10	10	200	150	5	363645	332151
11	12	150	85	5	363647	332175
12	12	200	150	5	363648	332182
13	14	150	90	5	363650	332205
② 14	8pc concrete bit round shank set with Ø 3/4/5/6/7/8/9/10 mm			3	352334	369935

Pos	Display material	Quantity	Id. No. 4939	EAN Code 4002395
1	1 m Assembled row	1	434656	557967
2	Euro hook (short)	14	434650	557905
3	Milwaukee® header strip	1	510100	900596
4	Barcode label strip concrete drill bits EU	1	530391	914364
5	Carton	1	4931373861	734399

4932 430499
4002395 381609

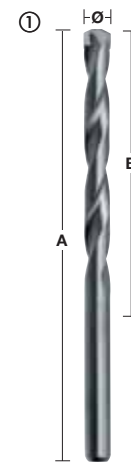

THUNDERWEB Metal drill bits
HSS Ground - DIN 338 - 1 metre row

Pos	Ø mm	A mm	B mm	Quantity	Id. No. 4932	EAN Code 4002395
1	1,0	34	12	5	352345	370047
2	1,5	40	18	5	352346	370054
3	2,0	49	24	5	352347	370061
4	2,5	57	30	5	352348	370078
5	3,0	61	33	5	352349	370085
6	3,2	65	36	5	352350	370092
7	3,5	70	39	5	352351	370108
8	4,0	75	43	5	352352	370115
9	4,5	80	47	5	352354	370139
10	5,0	86	52	5	352356	370153
11	6,0	93	57	5	352358	370177
12	7,0	109	69	5	352361	370207
13	8,0	117	75	5	352363	370221
14	9,0	125	81	5	352365	370245
15	10,0	133	87	5	352367	370269
16	11,0	142	94	5	352369	370283
17	12,0	151	101	5	352371	370306
18	13,0	151	101	5	352373	370320

Pos	Display material	Quantity	Id. No. 4939	EAN Code 4002395
1	1 m Assembled row	1	434656	557967
2	Euro hook (short)	18	434650	557905
3	Milwaukee® header strip	1	510100	900596
4	Barcode label strip HSS-G drill bits EU	1	530356	914722
5	Carton	1	4931373861	734399

4932 430500
4002395 381616



RED COBALT - HSS-Ground - DIN 338
Metal drill bits - 1 metre row

Pos	Ø mm	A mm	B mm	Quantity	Id. No. 4932	EAN Code 4002395
1	1,0	34	12	5	363248	333080
2	1,5	40	18	5	363249	333097
3	2,0	49	24	5	363250	333103
4	2,5	57	30	5	363251	333110
5	3,0	61	33	5	363253	333134
6	3,2	65	36	5	363254	333141
7	3,5	70	39	5	363256	333165
8	4,0	75	43	5	363258	333189
9	4,5	80	47	5	363262	333226
10	5,0	86	52	5	363264	333240
11	5,5	93	57	5	363267	333271
12	6,0	93	57	5	363268	333288
13	6,5	101	63	5	363269	333295
14	7,0	109	69	5	363271	333318
15	8,0	117	75	5	363274	333349
16	8,5	117	75	5	363276	333363
17	9,0	125	81	5	363277	333370
18	10,0	133	87	5	363279	333394
19	11,0	142	94	5	363282	333424
20	12,0	151	101	5	363284	333448
21	13,0	151	101	5	363286	333462

Pos	Display material	Quantity	Id. No. 4939	EAN Code 4002395
1	1 m Assembled row	1	434656	557967
2	Euro hook (short)	21	434650	557905
3	Milwaukee® header strip	1	510100	900596
4	Barcode label strip HSS-Co drill bits EU	1	530366	914623
5	Carton	1	4931373861	734399

4932 430501
4002395 381623



Wood auger bits 230 mm 1 metre row

Pos	Ø mm	A mm	B mm	C mm	Quantity	Id. No. 4932	EAN Code 4002395
1	8	230	155	6,5	3	363681	331796
2	10	230	155	8,5	3	363682	331802
3	12	230	155	10	3	363683	331819
4	14	230	155	11	3	363684	331826
5	16	230	155	11	3	363685	331833
6	18	230	155	11	3	363686	331840
7	20	230	155	11	3	363687	331857
8	22	230	155	11	3	373363	347889
9	24	230	155	11	3	373364	347896
10	26	230	155	11	3	373365	348503
11	28	230	155	11	3	373366	348510
12	30	230	155	11	3	373367	348527
13	32	230	155	11	2	373368	348534

Pos	Display material	Quantity	Id. No. 4939	EAN Code 4002395
1	1 m Assembled row	1	434656	557967
2	Euro hook (short)	13	434650	557905
3	Milwaukee® header strip	1	510100	900596
4	Barcode label strip wood auger bits 230 mm EU	1	530395	914326
5	Carton	1	4931373861	734399

4932 430502
4002395 381630



Wood auger bits 460 mm 1 metre row

Pos	Ø mm	A mm	B mm	C mm	Quantity	Id. No. 4932	EAN Code 4002395
1	8	460	385	6,5	3	363688	331710
2	10	460	385	8,5	3	363689	331727
3	12	460	385	10	3	363690	331734
4	14	460	385	11	3	363691	331741
5	16	460	385	11	3	363692	331758
6	18	460	385	11	3	363693	331765
7	20	460	385	11	3	363694	331772
8	22	460	385	11	3	363695	331789
9	24	460	385	11	3	373370	348558
10	26	460	385	11	3	373371	348565
11	28	460	385	11	3	373372	348572
12	30	460	385	11	3	373373	348589
13	32	460	385	11	2	373374	348596

Pos	Display material	Quantity	Id. No. 4939	EAN Code 4002395
1	1 m Assembled row	1	434656	557967
2	Euro hook (short)	13	434650	557905
3	Milwaukee® header strip	1	510100	900596
4	Barcode label strip wood auger bits 460 mm EU	1	530256	914852
5	Carton	1	4931373861	734399

4932 430503
4002395 381647



Brad point drill bits for wood - DIN 7487 E - 1 metre row

Pos	Ø mm	A mm	B mm	C mm	Quantity	Id. No. 4932	EAN Code 4002395
1	3	60	33	3	5	363651	331307
2	4	75	43	4	5	363652	331314
3	5	86	52	5	5	363653	331321
4	6	97	60	6	5	363654	331338
5	7	109	69	7	5	363655	331345
6	8	117	75	8	5	363656	331352
7	9	125	80	9	5	363657	331369
8	10	133	87	10	5	363658	331376
9	11	142	89	10	5	363659	331383
10	12	151	96	10	5	363660	331390
11	13	151	96	10	5	363661	331406
12	14	151	97	10	5	363662	331413
13	15	151	97	10	5	363663	331420
14	16	151	97	10	5	363664	331437
15	18	180	120	10	5	363665	331444
16	20	200	130	10	5	363666	331451

Pos	Display material	Quantity	Id. No. 4939	EAN Code 4002395
1	1 m Assembled row	1	434656	557967
2	Euro hook (short)	16	434650	557905
3	Milwaukee® header strip	1	510100	900596
4	Barcode label strip brad point drill bits for wood EU	1	530261	914890
5	Carton	1	4931373861	734399

4932 430504
4002395 381654



Flat boring bits 160 mm 1 metre row

Pos	Ø mm	A mm	Quantity	Id. No. 4932	EAN Code 4002395
1	8	160	5	363130	332618
2	10	160	5	363131	332625
3	12	160	5	363132	332632
4	13	160	5	363133	332649
5	14	160	5	363134	332656
6	16	160	5	363135	332663
7	18	160	5	363136	332670
8	19	160	5	363137	332687
9	20	160	5	363138	332694
10	22	160	5	363139	332700
11	24	160	5	363140	332717
12	25	160	5	363141	332724
13	26	160	5	363142	332731
14	28	160	5	363143	332748
15	30	160	5	363144	332755
16	32	160	5	363145	332762
17	36	160	5	363146	332779
18	38	160	5	363147	332786

Pos	Display material	Quantity	Id. No. 4939	EAN Code 4002395
1	1 m Assembled row	1	434656	557967
2	Euro hook (short)	18	434650	557905
3	Milwaukee® header strip	1	510100	900596
4	Barcode label strip flat boring bits 160 mm EU	1	530259	914883
5	Carton	1	4931373861	734399

4932 430505
4002395 381661



SHOCKWAVE Impact Duty™ drilling & driving - 1 metre row

Pos	Size	A mm	Quantity	Id. No. 4932	EAN Code 4002395	
①	1	PH 1	25	5	430850	385126
	2	PH 2	25	5	430852	385140
	3	PH 2	50	5	430854	385164
	4	PZ 1	25	5	430860	385225
	5	PZ 2	25	5	430863	385256
	6	PZ 2	50	5	430865	385270
	7	PZ 3	25	5	430868	385300
	8	TX 15	25	5	430872	385348
	9	TX 20	25	5	430874	385362
	10	TX 25	25	5	430879	385416
	11	TX 30	25	5	430885	385478
②	Magnetic bit holder 60 mm length		5	352406	370658	
③ Magnetic nut drivers						
13	Hex 8	65	4	352541	370726	
14	Hex 10	65	4	352543	370740	
15	Hex 13	65	4	352545	370764	
④	Shockwave HSS-G TiN Red Hex drill bit set in plastic cassette (10 pcs) with Ø 3/3.5/4/4.5/5/6/7/8/9/10 mm		3	48894759	045242502066	

Pos	Display material	Quantity	Id. No. 4939	EAN Code 4002395
1	1 m Assembled row	1	434656	557967
2	Euro hook (short)	16	434650	557905
3	Milwaukee® header strip	1	510100	900596
4	Barcode label strip SHOCKWAVE EU	1	434828	192038
5	Carton	1	4931373861	734399

4932 451316
4002395 151981

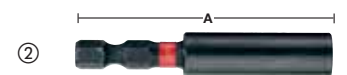
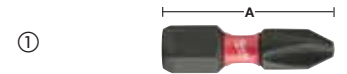

Chucks 1 metre row

Pos	Item	Reception	Quantity	Id. No. 4932	EAN Code 4002395
1	Three jaw chuck	3/8" x 24 1,0-10	1	373412	349760
2	Three jaw chuck	1/2" x 20 1,0-10	2	269401	302932
3	Three jaw chuck	1/2" x 20 1,5-13	2	218111	300051
4	Three jaw chuck	1/2" x 20 1,5-13	2	267980	300488
5	Three jaw chuck	M18 x 2,5 3,0-16	1	320014	310784
6	Quick action chuck	FIXTEC 1,5-13	1	371913	345366
7	Keyless chuck	3/8" x 24 1,0-10	1	349457	318155
8	Keyless chuck	1/2" x 20 1,0-10	1	364382	337675
9	Keyless chuck	1/2" x 20 1,0-13	1	364266	334063
10	Quick action chuck	1/2" x 20 1,5-13	1	376533	346349
11	Keyless chuck	1/2" x 20 1,5-13	1	364267	334070
12	Chuck key	1/2" x 20	5	221378	302765

Pos	Display material	Quantity	Id. No. 4939	EAN Code 4002395
1	1 m Assembled row	1	434656	557967
2	Euro hook (short)	12	434650	557905
3	Milwaukee® header strip	1	510100	900596
4	Barcode label strip chucks EU	1	530273	915002
5	Carton	1	4931373861	734399

4932 430507
4002395 381685



Jigsaw blades for wood, plastics & metal - 1 metre row

Pos	Blade length (toothed) mm	Tooth pitch mm	Ref. No.	Quantity	Id. No. 4932	EAN Code 4002395
1	55	1,2	T 118 A	5	254063	301614
2	91	2,5/1,8	T 123 XF	5	430142	378036
3	75	3,0	T 127 D	5	274315	301560
4	75	4,0	T 144 D	5	213116	301492
5	75	2,5	T 101 B	5	254061	301522
6	75	4,0	T 101 D	5	274351	301515
7	75	2,5	Curve	5	430143	378043
8	91	2,5	T 234 X	5	430141	378029
9	105	4,0	T 344 D	5	311633	301508
10	5pc jigsaw blade set with 213116, 254061, 254063, 254064, 254071			5	345825	314850

Pos	Display material	Quantity	Id. No. 4939	EAN Code 4002395
1	1 m Assembled row	1	434656	557967
2	Euro hook (short)	10	434650	557905
3	Milwaukee® header strip	1	510100	900596
4	Barcode label strip jigsaw blades top line EU	1	530372	914555
5	Carton	1	4931373861	734399

4932 430508
4002395 381692



Jigsaw blades for wood & plastics 1 metre row

Pos	Blade length (toothed) mm	Tooth pitch mm	Ref. No.	Quantity	Id. No. 4932	EAN Code 4002395
1	75	4,0	T 144 D	5	213116	301492
2	75	2,5	T 101 B	5	254061	301522
3	105	4,0	T 301 DL	5	346071	312399
4	75	4,0	T 101 D	5	274351	301515
5	91	2,5	T 234 X	5	430141	378029
6	75	2,5	T 101 BR	5	346079	312382
7	75	2,5/1,2	Curve	5	430143	378043
8	105	4,0	T 344 D	5	311633	301508
9	75	3,0	T 111 C	5	254071	301539
10	5pc jigsaw blade set with 213116, 254061, 254063, 254064, 254071			5	345825	314850

Pos	Display material	Quantity	Id. No. 4939	EAN Code 4002395
1	1 m Assembled row	1	434656	557967
2	Euro hook (short)	10	434650	557905
3	Milwaukee® header strip	1	510100	900596
4	Barcode label strip jigsaw blades for wood & plastics EU	1	530376	914517
5	Carton	1	4931373861	734399

4932 430509
4002395 381708



Jigsaw blades for metal 1 metre row

Pos	Blade length (toothed) mm	Tooth pitch mm	Ref. No.	Quantity	Id. No. 4932	EAN Code 4002395
1	55	1,2	T 118 A	5	254063	301614
2	55	2,0	T 118 B	5	254064	301591
3	75	3,0	T 127 D	5	274315	301560
4	75	1,2	T 118 AF	5	340011	304684
5	91	2,5/1,8	T 123 XF	5	430142	378036
6	75	1,2	T 118 A sp.	5	345826	313464
7	75	0,7	T 118 G	5	274652	301621
8	105	1,2	T 318 AF	5	274654	301607
9	105	2,0	T 318 BF	5	274653	301584
10	5pc jigsaw blade set with 213116, 254061, 254063, 254064, 254071			5	345825	314850

Pos	Display material	Quantity	Id. No. 4939	EAN Code 4002395
1	1 m Assembled row	1	434656	557967
2	Euro hook (short)	10	434650	557905
3	Milwaukee® header strip	1	510100	900596
4	Barcode label strip jigsaw blades for metal EU	1	530379	914487
5	Carton	1	4931373861	734399

4932 430510
4002395 381715



Abrasive paper - Hook & Loop 100x147 mm - 1 metre row

Pos	Grit	Paper size mm A x B	Quantity	Id. No. 4932	EAN Code 4002395
1	60	100x147	3	355140	319992
2	60	100x147	3	355140	319992
3	80	100x147	3	355141	320004
4	80	100x147	3	355141	320004
5	120	100x147	3	355142	320011
6	180	100x147	3	355143	320028
7	240	100x147	3	355144	320035

Pos	Display material	Quantity	Id. No. 4939	EAN Code 4002395
1	1 m Assembled row	1	434656	557967
2	Euro hook (short)	7	434650	557905
3	Milwaukee® header strip	1	510100	900596
4	Barcode label strip abrasive paper 100x147 mm EU	1	530281	915071
5	Carton	1	4931373861	734399

4932 430511
4002395 381722

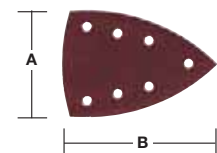

Abrasive paper - Hook & Loop 105x105 mm - 1 metre row

Pos	Grit	Paper size mm A x B	Quantity	Id. No. 4932	EAN Code 4002395
1	60	105 x 105	3	358492	324248
2	60	105 x 105	3	358492	324248
3	80	105 x 105	3	358493	324255
4	80	105 x 105	3	358493	324255
5	120	105 x 105	3	358494	324262
6	180	105 x 105	3	358495	324279
7	240	105 x 105	3	358496	324286

Pos	Display material	Quantity	Id. No. 4939	EAN Code 4002395
1	1 m Assembled row	1	434656	557967
2	Euro hook (short)	8	434650	557905
3	Milwaukee® header strip	1	510100	900596
4	Barcode label strip abrasive paper 105x105 mm EU	1	530285	915118
5	Carton	1	4931373861	734399

4932 430557
4002395 382187

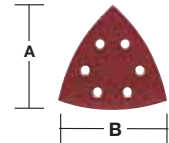

Abrasive paper - Hook & Loop Ø 125 mm 8 holes - 1 metre row

Pos	Grit	Paper size mm Ø	Quantity	Id. No. 4932	EAN Code 4002395
1	40	125	3	367740	338610
2	60	125	3	367741	338627
3	60	125	3	367741	338627
4	80	125	3	367742	338634
5	120	125	3	367743	338641
6	180	125	3	367744	338658
7	240	125	3	367745	338665

Pos	Display material	Quantity	Id. No. 4939	EAN Code 4002395
1	1 m Assembled row	1	434656	557967
2	Euro hook (short)	7	434650	557905
3	Milwaukee® header strip	1	510100	900596
4	Barcode label strip abrasive paper Ø 125 mm EU	1	530422	914258
5	Carton	1	4931373861	734399

4932 430512
4002395 381739

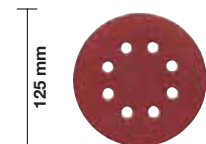

Abrasive paper - Hook & Loop Ø 150 mm - 6 holes 1 metre row

Pos	Grit	Paper size mm Ø	Quantity	Id. No. 4932	EAN Code 4002395
1	40	150	3	371590	343171
2	60	150	3	371591	343188
3	80	150	3	371592	343195
4	120	150	3	371593	343201
5	180	150	3	371594	343218
6	240	150	3	371595	343225

Pos	Display material	Quantity	Id. No. 4939	EAN Code 4002395
1	1 m Assembled row	1	434656	557967
2	Euro hook (short)	6	434650	557905
3	Milwaukee® header strip	1	510100	900596
4	Barcode label strip abrasive paper Ø 150 mm EU	1	530399	914289
5	Carton	1	4931373861	734399

4932 430513
4002395 381746

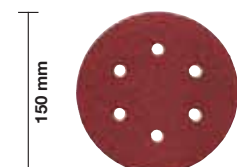

Abrasive belts - 100x620 mm 1 metre row

Pos	Grit	Paper size mm A x B	Quantity	Id. No. 4932	EAN Code 4002395
1	40	100x620	2	341610	304882
2	60	100x620	2	341611	304899
3	60	100x620	2	341611	304899
4	80	100x620	2	341612	304905
5	100	100x620	2	341613	304912
6	150	100x620	2	341614	304929
7	240	100x620	2	341615	304936

Pos	Display material	Quantity	Id. No. 4939	EAN Code 4002395
1	1 m Assembled row	1	434656	557967
2	Euro hook (short)	7	434650	557905
3	Milwaukee® header strip	1	510100	900596
4	Barcode label strip abrasive belts 100x620 mm EU	1	530425	914227
5	Carton	1	4931373861	734399

4932 430558
4002395 382194

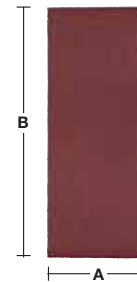

Abrasive belts - 100x610 mm 1 metre row

Pos	Grit	Paper size mm A x B	Quantity	Id. No. 4932	EAN Code 4002395
1	40	100x610	2	355066	319824
2	60	100x610	2	355067	319831
3	60	100x610	2	355067	319831
4	80	100x610	2	355068	319848
5	100	100x610	2	355069	319855
6	150	100x610	2	355070	319862
7	240	100x610	2	355071	319879

Pos	Display material	Quantity	Id. No. 4939	EAN Code 4002395
1	1 m Assembled row	1	434656	557967
2	Euro hook (short)	7	434650	557905
3	Milwaukee® header strip	1	510100	900596
4	Barcode label strip abrasive belts 100x610 mm EU	1	530428	914227
5	Carton	1	4931373861	734399

4932 430559
4002395 382200

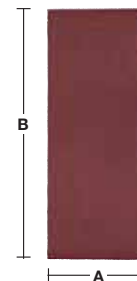

Abrasive belts - 75x533 mm 1 metre row

Pos	Grit	Paper size mm A x B	Quantity	Id. No. 4932	EAN Code 4002395
1	40	75x533	2	312475	301263
2	60	75x533	2	312476	301270
3	60	75x533	2	312476	301270
4	80	75x533	2	312477	301287
5	80	75x533	2	312477	301287
6	100	75x533	2	312478	301294
7	100	75x533	2	312478	301294
8	150	75x533	2	312479	301300
9	240	75x533	2	312480	301317

Pos	Display material	Quantity	Id. No. 4939	EAN Code 4002395
1	1 m Assembled row	1	434656	557967
2	Euro hook (short)	9	434650	557905
3	Milwaukee® header strip	1	510100	900596
4	Barcode label strip abrasive belts 75x533 mm EU	1	530429	914180
5	Carton	1	4931373861	734399

4932 430514
4002395 381753

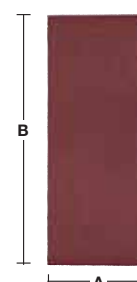

SAWZALL[®] blades for wood/ demolition/universal - 1 metre row

Pos	Blade length	Teeth per inch	Application	Quantity	Id. No.	UPC Code 45242
1	230	6	Wood	5	48005016	082636
2	300	6	Wood	5	48001079	079858
3	150	5	Demolition	5	48005035	082698
4	230	5	Demolition	5	48005036	082704
5	300	5	Demolition	5	48005037	082711
6	150	5	Demolition AX	5	48005021	082988
7	230	5	Demolition AX	5	48005026	082995
8	300	5	Demolition AX	5	48005027	083022
9	150	10/14	Universal	5	48005292	084067
10	200	10/14	Universal	5	48005293	084074
11	150	8/12	Universal	5	48005091	082759
12	200	8/12	Universal	5	48005093	082773
13	300	8/12	Universal	5	48005094	082780
14	300	knife	Insulation mat.	5	48001084	079902
15	125	6	Drywall	5	48005052	082735

Pos	Display material	Quantity	Id. No. 4939	EAN Code 4002395
1	1 m Assembled row	1	434656	557967
2	Euro hook (short)	15	434650	557905
3	Milwaukee [®] header strip	1	510100	900596
4	Barcode label strip SAWZALL [®] blades for wood/demolition/universal	1	565538	936236
5	Carton	1	4931373861	734399

4932 430515
4002395 381760



SAWZALL[®] blades for wood/metal demolition/universal - 1 metre row

Pos	Blade length	Teeth per inch	Application	Quantity	Id. No.	UPC Code 45242
1	300	6	Wood	5	48001079	079858
2	150	6	Demolition	5	48005035	082698
3	230	6	Demolition	5	48005036	082704
4	300	6	Demolition	5	48005037	082711
5	200	10/14	Universal	5	48005293	084074
6	200	8/12	Universal	5	48005093	082773
7	300	8/12	Universal	5	48005094	082780
8	150	18	Metal	5	48005184	082858
9	230	18	Metal	5	48005188	082896
10	300	18	Metal	5	48005189	082902
11	150	14	Metal	5	48005182	082834
12	230	14	Metal	5	48005187	082889
13	230	18	Metal – Torch	5	48005788	083091
14	230	14	Metal – Torch	5	48005787	083077
15	230	10	Metal – Torch	5	48005713	083046
16	230		Cast iron – Coarse grit	5	48001430	082001

Pos	Display material	Quantity	Id. No. 4939	EAN Code 4002395
1	1 m Assembled row	1	434656	557967
2	Euro hook (short)	16	434650	557905
3	Milwaukee [®] header strip	1	510100	900596
4	Barcode label strip SAWZALL [®] blades top line EU	1	565539	936243
5	Carton	1	4931373861	734399

4932 430516
4002395 381777



SAWZALL® blades for metal 1 metre row

Pos	Blade length	Teeth per inch	Application	Quantity	Id. No.	UPC Code 45242
1	150	25	Metal	5	48005186	082872
2	150	18	Metal	5	48005184	082858
3	230	18	Metal	5	48005188	082896
4	300	18	Metal	5	48005189	082902
5	150	14	Metal	5	48005182	082834
6	230	14	Metal	5	48005187	082889
7	150	18	Metal – Torch	5	48005784	083084
8	230	18	Metal – Torch	5	48005788	083091
9	300	18	Metal – Torch	5	48005789	083107
10	150	14	Metal – Torch	5	48005782	083060
11	230	14	Metal – Torch	5	48005787	083077
12	150	10	Metal – Torch	5	48005712	083039
13	230	10	Metal – Torch	5	48005713	083046
14	150		Cast iron – Coarse grit	5	48001420	081950
15	230		Cast iron – Coarse grit	5	48001430	082001

4932 430517
4002395 381784



Pos	Display material	Quantity	Id. No. 4939	EAN Code 4002395
1	1 m Assembled row	1	434656	557967
2	Euro hook (short)	15	434650	557905
3	Milwaukee® header strip	1	510100	900596
4	Barcode label strip SAWZALL® blades for metal	1	565540	936250
5	Carton	1	4931373861	734399



SAWZALL® blades for metal – top line 1 metre row

Pos	Blade length	Teeth per inch	Application	Quantity	Id. No.	UPC Code 45242
1	150	18	Metal – Ice Hardened	5	48004184	081042
2	230	18	Metal – Ice Hardened	5	48004188	081066
3	150	14	Metal – Ice Hardened	5	48004182	081035
4	230	14	Metal – Ice Hardened	5	48004187	080991
5	150	18	Metal – Torch Ice Hardened	5	48004784	081110
6	230	18	Metal – Torch Ice Hardened	5	48004788	081134
7	150	14	Metal – Torch Ice Hardened	5	48004782	081097
8	230	14	Metal – Torch Ice Hardened	5	48004787	081127
9	150	10	Metal – Torch Ice Hardened	5	48004712	081073
10	230	10	Metal – Torch Ice Hardened	5	48004713	081080
11	150	8	Metal – Wrecker	5	48005701	082476
12	230	8	Metal – Wrecker	5	48005706	082483
13	300	8	Metal – Wrecker	5	48005711	082490

4932 430518
4002395 381791



Pos	Display material	Quantity	Id. No. 4939	EAN Code 4002395
1	1 m Assembled row	1	434656	557967
2	Euro hook (short)	13	434650	557905
3	Milwaukee® header strip	1	510100	900596
4	Barcode label strip SAWZALL® blades metal top line	1	565541	936267
5	Carton	1	4931373861	734399



SDS-Plus MX4 4 cut drill bits & chisels - Red Rack



Pos	Ø mm	A mm	B mm	Quantity	Id. No. 4932	EAN Code 4002395	
①	1	5	115	50	5	352007	366644
	2	6	115	50	5	352011	368921
	3	6	165	100	5	352012	368938
	4	6	215	150	5	352013	366705
	5	6	265	200	5	352014	366712
	6	8	115	50	5	352021	366781
	7	8	165	100	5	352022	366798
	8	8	215	150	5	352023	366804
	9	8	265	200	5	352024	366811
	10	10	110	50	5	352025	366828
	11	10	160	100	5	352026	366835
	12	10	210	150	5	352027	366842
	13	10	260	200	5	352028	366859
	14	12	160	100	5	352031	366880
	15	12	210	150	5	352032	366897
	16	12	260	200	5	352033	366903
	17	14	160	100	5	352036	366934
	18	14	210	150	5	352037	366941
②	19	Pointed chisel	250	-	5	339625	304813
③	20	Wide chisel	250	40	5	367146	334377
④	21	7pc SDS-Plus MX4 drill bit set with Ø 5/6/8x115 mm, Ø 6/8x165 mm and Ø 10/12x160 mm			3	451464	162147

4932 352637
4002395 372959

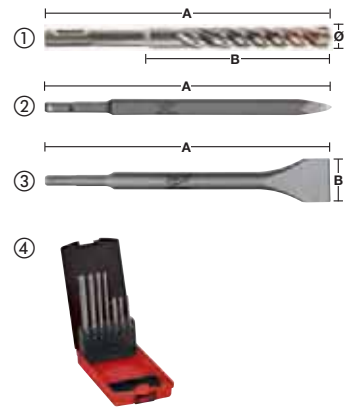

Pos	Display material	Quantity	Id. No. 4939	EAN Code 4002395
1	Red Rack/Header Card	1	434075	930852
2	Euro hook (short)	20	434076	920655
3	Euro hook (long)	1	434077	920662
4	Re Order Tag Set (10pcs)	3	434080	920648
5	Barcode label set SDS-plus MX4 drill bits/chisels	1	434082	920563
6	Planogram SDS-plus MX4 drill bits/chisels (EU)	1	434169	923892

SDS-Plus M2 2 cut drill bits & chisels - Red Rack



Pos	Ø mm	A mm	B mm	Quantity	Id. No. 4932	EAN Code 4002395	
①	1	5	110	50	5	307067	308835
	2	6	110	50	5	307068	308842
	3	6	160	100	5	307069	308859
	4	6	210	150	5	373136	346394
	5	6	260	200	5	353819	320127
	6	8	110	50	5	307070	308866
	7	8	160	100	5	307071	308873
	8	8	210	150	5	307072	308880
	9	8	260	200	5	353821	320141
②	10	Pointed chisel	250	-	5	339625	304813
③	11	Wide chisel	250	40	5	367146	334377
	12	10	160	100	5	307073	308897
	13	10	210	150	5	307074	308903
	14	10	260	200	5	344295	312252
	15	12	160	100	5	307075	308910
	16	12	210	150	5	307076	308927
	17	14	160	100	5	307078	308941
	18	14	260	200	5	307079	308958
④	19	7pc SDS-plus drill bit set with Ø 5/6/8x110 mm and Ø 6/8/10/12x160 mm			4	352339	369980

4932 352634
4002395 372928

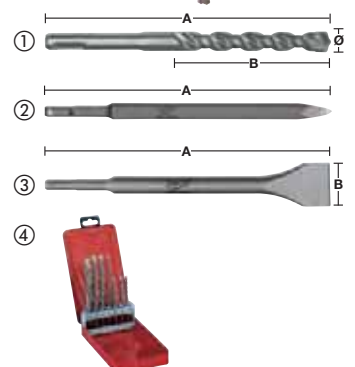

Pos	Display material	Quantity	Id. No. 4939	EAN Code 4002395
1	Red Rack/Header Card	1	434075	930852
2	Euro hook (short)	18	434076	920655
3	Euro hook (long)	1	434077	920662
4	Re Order Tag Set (10pcs)	2	434080	920648
5	Barcode label set SDS-plus drill bits/chisels	1	434081	920556
6	Planogram SDS-plus drill bits/chisels (EU)	1	434166	923861

Concrete & multipurpose drill bits Red Rack

Pos	Ø mm	A mm	B mm	Quantity	Id. No. 4932	EAN Code 4002395
Concrete drill bits						
① 1	4	85	50	5	363631	332014
2	5	85	50	5	363633	332038
3	5	150	90	5	363634	332045
4	6	100	60	5	363636	332069
5	6	150	90	5	363637	332076
6	8	120	80	5	363640	332106
7	8	200	150	5	363641	332113
8	9	120	80	5	363643	332137
9	10	120	80	5	363644	332144
10	12	150	85	5	363647	332175
11	14	150	90	5	363650	332205
② 12	5pc concrete drill bit set with Ø 4/5/6/8/10 mm			5	352333	369928
③ 13	8pc concrete drill bit set with Ø 3/4/5/6/7/8/9/10 mm			5	352334	369935
Multipurpose drill bits						
④ 14	7pc multipurpose drill bit set with Ø 3/4/5/6/6/8/10 mm			5	352335	369942
⑤ 15	4	85	50	5	430148	378098
16	5	85	50	5	430149	378104
17	6	100	60	5	430152	378135
18	8	120	80	5	430158	378197
19	10	120	80	5	430160	378210

Pos	Display material	Quantity	Id. No. 4939	EAN Code 4002395
1	Red Rack/Header Card	1	434075	930852
2	Euro hook (short)	16	434076	920655
3	Euro hook (long)	3	434077	920662
4	Re Order Tag Set (10pcs)	2	434080	920648
5	Barcode label set concrete & multipurpose drill bits	1	434085	920594
6	Planogram concrete & multipurpose drill bits (EU)	1	434172	923922

4932 352640
4002395 372980

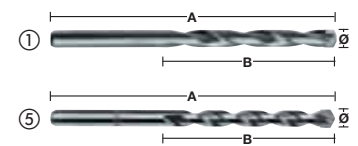

Wood auger bits 230 mm Red Rack

Pos	Ø mm	A mm	B mm	C mm	Quantity	Id. No. 4932	EAN Code 4002395
① 1	8	230	155	6.5	3	363681	331796
2	10	230	155	8.5	3	363682	331802
3	12	230	155	10	3	363683	331819
4	14	230	155	11	3	363684	331826
5	16	230	155	11	3	363685	331833
6	18	230	155	11	3	363686	331840
7	20	230	155	11	3	363687	331857
② 8	5pc impact wood auger bit set with Ø 14/16/18/20/22x470 mm			3	352285	369447	
9	22	230	155	11	3	373363	347889
10	24	230	155	11	3	373364	347896
11	26	230	155	11	3	373365	348503
12	28	230	155	11	3	373366	348510
13	30	230	155	11	3	373367	348527
14	32	230	155	11	2	373368	348534

Pos	Display material	Quantity	Id. No. 4939	EAN Code 4002395
1	Red Rack/Header Card	1	434075	930852
2	Euro hook (short)	13	434076	920655
3	Euro hook (long)	2	434077	920662
4	Re Order Tag Set (10pcs)	2	434080	920648
5	Barcode label set wood auger bits 230 mm	1	434086	920600
6	Planogram wood auger bits 230 mm	1	434175	923953

4932 352643
4002395 373017

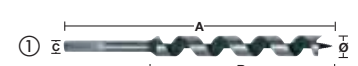

THUNDERWEB Metal drill bits HSS-Ground - DIN 338 - Red Rack

Pos	Ø mm	A mm	B mm	Quantity	Id. No. 4932	EAN Code 4002395
① 1	1,0	34	12	5	352345	370047
2	1,5	40	18	5	352346	370054
3	2,0	49	24	2	352347	370061
4	2,5	57	30	2	352348	370078
5	3,0	61	33	2	352349	370085
6	3,2	65	36	2	352350	370092
7	3,5	70	39	5	352351	370108
8	4,0	75	43	5	352352	370115
9	4,5	80	47	5	352354	370139
10	4,8	86	52	5	352355	370146
11	5,0	86	52	5	352356	370153
12	6,0	93	57	5	352358	370177
13	7,0	109	69	5	352361	370207
14	8,0	117	75	5	352363	370221
15	9,0	125	81	5	352365	370245
16	10,0	133	87	5	352367	370269
17	11,0	142	94	5	352369	370283
18	12,0	151	101	5	352371	370306
② 19	25pc HSS-G metal drill bit set			3	352376	370351
③ 20	19pc HSS-G metal drill bit set			4	352374	370337
21	13,0	151	101	5	352373	370320

Pos	Display material	Quantity	Id. No. 4939	EAN Code 4002395
1	Red Rack/Header Card	1	434075	930852
2	Euro hook (short)	19	434076	920655
3	Euro hook (long)	4	434077	920662
4	Re Order Tag Set (10pcs)	3	434080	920648
5	Barcode label set HSS-G metal drill bits	1	434084	920587
6	Planogram HSS-G metal drill bits	1	434177	923977

4932 352645
4002395 373031



SAWZALL® blades Red Rack

Pos	Blade length	Teeth per inch	Application	Quantity	Id. No.	UPC Code 45242
1	230	6	Wood	5	48005016	082636
2	150	5	Demolition AX	5	48005021	082988
3	230	5	Demolition AX	5	48005026	082995
4	300	5	Demolition AX	5	48005027	083022
5	230	5	Demolition AX	5	48005036	082704
6	200	10/14	Universal	5	48005293	084074
7	150	8/12	Universal	5	48005091	082759
8	200	8/12	Universal	5	48005093	082773
9	230		Cast iron - Diamond grit	3	48001450	187416
10	450	2,1	Brick	3	48001460	235353
11	150	18	Metal	5	48005184	082858
12	230	18	Metal	5	48005188	082896
13	230	14	Metal	5	48005187	082889
14	150	14	Metal	5	48005182	082834
15	230	14	Metal - Torch	5	48005787	083077
16	150	14	Metal - Torch	5	48005782	083060
17	300	18	Metal	5	48005189	082902

Pos	Display material	Quantity	Id. No. 4939	EAN Code 4002395
1	Red Rack/Header Card	1	434075	930852
2	Euro hook (short)	17	434076	920655
3	Euro hook (long)	2	434080	920648
4	Barcode label set SAWZALL® blades	1	434087	920617
5	Planogram SAWZALL® blades	1	434179	923991

4932 352647
4002395 373055



Jigsaw blades Red Rack

Pos	Blade length (toothed) mm	Tooth pitch mm	Ref. No.	Quantity	Id. No. 4932	EAN Code 4002395
1	75	4,0	T 144 D	5	213116	301492
2	55	2,0	T 118 B	5	254064	301591
3	75	2,5	T 101 B	5	254061	301522
4	75	4,0	T 101 D	5	274351	301515
5	75	3,0	T 111 C	5	254071	301539
6	91	2,5	T 234 X	5	430141	378029
7	75	4,0	Special	5	265312	301478
8	75	2,5	T 101 BR	5	346079	312382
9	105	4,0	T 344 D	5	311633	301508
10	105	4,0	T 301 DL	5	346071	312399
11	5pc jigsaw blade set with 213116, 254061, 254063, 254064, 254071			5	345825	314850
12	55	0,7	T 118 G	5	274652	301621
13	55	1,2	T 118 A	5	254063	301614
14	75	1,2	T 118 A	5	345826	313464
15	91	2,5/1,8	T 123 XF	5	430142	378036
16	55	1,2	T 118 AF	5	340011	304684
17	55	2,0	T 118 BF	5	340012	304691
18	105	2,0	T 318 BF	5	274653	301584

Pos	Display material	Quantity	Id. No. 4939	EAN Code 4002395
1	Red Rack/Header Card	1	434075	930852
2	Euro hook (short)	18	434076	920655
3	Euro hook (long)	2	434080	920648
4	Barcode label set jigsaw blades	1	434089	920631
5	Planogram jigsaw blades	1	434180	924004

4932 352648
4002395 373062



Holesaws Red Rack

Pos	Application	Quantity	Id. No.	UPC Code 45242
1	Holesaw 19 mm	2	49560023	192632
2	Holesaw 20 mm	2	49560024	271016
3	Holesaw 22 mm	2	49560032	192878
4	Holesaw 25 mm	2	49560043	192526
5	Holesaw 32 mm	2	49560062	192977
6	Holesaw 35 mm	2	49560072	192991
7	Holesaw 40 mm	2	49560087	193042
8	Holesaw 44 mm	2	49560102	193097
9	Holesaw 52 mm	2	49560122	193172
10	Holesaw 54 mm	2	49560127	193189
11	Holesaw 60 mm	2	49560142	193233
12	Holesaw 65 mm	2	49560153	193271
13	Holesaw 67 mm	2	49560158	193288
14	Holesaw 76 mm	1	49560173	193332
15	Holesaw 86 mm	1	49560187	193387
16	Holesaw 102 mm	1	49560213	193486
17	Holesaw 111 mm	1	49560227	193530
18	Arbor 9.5 mm / 14-30 mm	2	49567010	200177
19	Arbor 9,5 mm / 32-210 mm	2	49567250	225798
20	Arbor 11 mm / 32-210 mm	2	49569100	200832
21	Pilot drill 6x89	5	49568010	200450
22	Holesaw 4/6 Set-17pcs	1	49224102	271054

Pos	Display material	Quantity	Id. No. 4939	EAN Code 4002395
1	Red Rack/Header Card	1	434075	930852
2	Euro hook (short)	6	434076	920655
3	Euro hook (long)	15	434077	920662
4	Re Order Tag (10pcs)	3	434080	920648
5	EAN LB	1	434409	551521

4932 430177
4002395 378388



SHOCKWAVE Impact Duty™ Drilling & Driving - Red Rack

4932 451317
4002395 151998

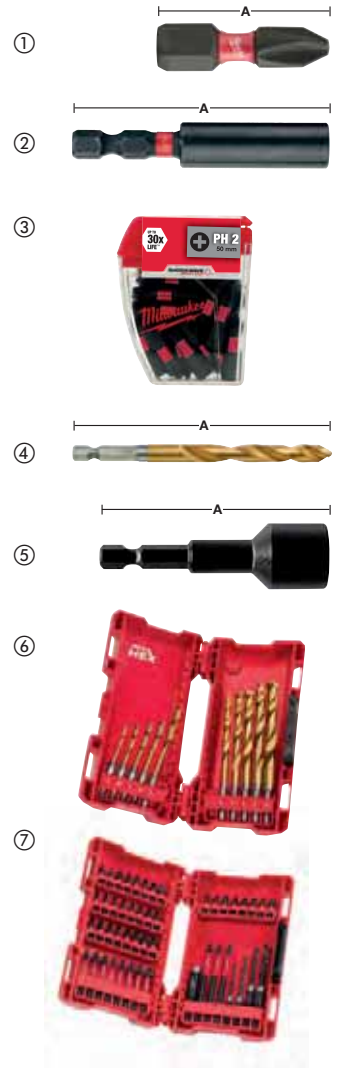

Pos	Size Ø mm	A mm	Quantity	Id. No. 4932	EAN Code 4002395
① Screwdriving bits					
1	PH 1	25	5	430850	385126
2	PH 2	25	5	430852	385140
3	PZ1	25	5	430860	385225
4	PZ 2	25	5	430863	385256
5	PZ 3	25	5	430868	385300
6	TX 10	25	5	430871	385331
7	TX 15	25	5	430872	385348
8	TX 20	25	5	430874	385362
9	TX 25	25	5	430879	385416
10	TX 30	25	5	430885	385478
11	Hex 4 mm	25	5	430895	385577
12	Hex 5 mm	25	5	430896	385584
13	PH 2	50	5	430854	385164
14	PZ 2	50	5	430865	385270
15	TX 20	50	5	430876	385386
16	TX 25	50	5	430881	385430
②	Magnetic bit holder	65	8	352406	370658
	Magnetic bit holder	152	5	48324511	45242301980
③	PH 2 (25pc box)	25	3	430853	385157
	PZ 2 (25pc box)	25	3	430864	385263
	TX 20 (25pc box)	25	3	430875	385379
	TX 25 (25pc box)	25	3	430880	385423
④ RED HEX - Shockwave HSS-Ground Titanium Metal drill bits					
23	3,0	70	5	48894763	045242506866
24	4,0	80	5	48894708	045242501595
25	5,0	90	5	48894712	045242501632
26	6,0	93	5	48894714	045242501649
⑤ Magnetic nut drivers					
27	7,0	65	5	352539	371976
28	8,0	65	5	352541	371990
29	10,0	65	4	352543	372010
30	13,0	65	4	352545	372034
⑥	Shockwave HSS-G TiN Red Hex drill bit set in plastic cassette (10 pcs) with Ø 3/3.5/4/4.5/5/6/7/8/9/10 mm		3	48894759	045242502066
⑦	48pc Shockwave Impact Duty™ drill & drive set		3	430906	385683

Pos	Display material	Quantity	Id. No. 4939	EAN Code 4002395
1	Red Rack/ Header Card	1	434075	930852
2	Euro hook (short)	26	434076	920655
3	Euro hook (long)	7	434077	920662
4	Re Order Tag Set (10pcs)	4	434080	920648
5	Barcode label set Shockwave Impact Duty™ Accessories	1	434088	920624
6	Planogram Shockwave Impact Duty™ Accessories	1	434178	923984



Nothing but **HEAVY DUTY.**[™]

Techtronic Industries GmbH

Max-Eyth-Str. 10
D-71364 Winnenden
Germany
Tel. +49 7195 12 0
Fax +49 7195 666

Distributed by: